



SWIFT GROUP

Dunswell Road

Cottingham

East Yorkshire HU16 4JX

Tel 01482 875740

Fax 01482 840082

email enquiry@swiftgroup.co.uk

For more information visit

www.swiftgroup.co.uk

Issued July 2016

FIND OUT MORE SWIFTGROUP.CO.UK



BROCHURE
DOWNLOADS



FIND A
DEALER



FACEBOOK AND
SWIFT-TALK.CO.UK



PRODUCT VIDEOS
SWIFTTV.CO.UK





CARAVAN

OWNER'S SERVICE AND WARRANTY HANDBOOK





AL-KO PREMIUM ACCESSORIES: MAKING YOUR CARAVAN HOLIDAY SAFER AND MORE SECURE

We know that your caravan holiday starts the moment that you pull off your drive. So at AL-KO we have designed a high quality premium range of accessory products to ensure that your holiday starts and ends safely and securely.

For more information on the range of AL-KO accessories available for your caravan, visit our website or email us at marketing@al-ko.co.uk.



Scan with your smart phone to visit our website

marketing@al-ko.co.uk | www.al-ko.co.uk

AL-KO

QUALITY FOR LIFE



MOMENTS TO SAVOUR

TAKEN CARE OF

PERFECT FOR RECHARGING YOUR BATTERIES

Why wait to discover, explore and relax your way to a different place? Whether you are craving adventure or just in need of some quality time together; we'll guide you through our huge variety of sites to help you find your perfect place to unwind. Because to us it's not just a hobby - it's a way of life. We are camping.

With membership from as little as £37 call 024 7767 0393
www.campingandcaravanningclub.co.uk



The
Camping and
Caravanning
Club
The Friendly Club



TYRE-LINE

SINCE 1984 TYRE-LINE HAS BEEN SERVING ORIGINAL EQUIPMENT MANUFACTURERS IN THE TOURING CARAVAN, TRUCK, COACH, TRAILER AND SPORTS CAR MARKETS WITH SPECIALIST WHEELS AND TYRES

CARAVAN & MOTORHOME



COMMERCIAL VEHICLE WHEELS



AUTOMOTIVE TIER 1



TRAILER & PLANT EQUIPMENT



TURF, AMENITY & GARDEN



ENGINEERED PARTS



WWW.TYRELINE.COM



TELEPHONE: +44 (0)1327 701000
EMAIL: SALES@TYRELINE.COM





VIEW FROM - KALARI, NORFOLK, ENGLAND

INNOVATING THE FUTURE FROM OUR PAST

VARKALA

- | Vango AirAwning® Structure – Tried and trusted, easy to inflate structure
- | Sentinel Pro 420 Fabric – High quality 420D double ripstop polyester
- | Zipped privacy curtains – Fully customizable for light & ventilation
- | Storm straps included – Secures your awning in bad weather
- | Included extras - Foam draught excluder pads, PVC vented draft excluder, strip & wheel arch covers
- | Flexible door/window opening – Provides extra ventilation or cover for your awning
- | Adjustable pegging points – Ensures a perfect fit on uneven surfaces



SINCE 1966

Dometic compact roof air conditioners

FreshJet 2200 awarded
Best Buy

- Most compact rooftop air conditioner
- Lightest
- Quietest
- Lowest starting current
- Lowest power consumption



NOW
Available in 4
performance
levels



*In an air conditioning comparison test by Reise Mobil International Magazine



Dometic FreshJet 1100, 1700 & 2200

- 3 performance levels for vehicles up to 5 m, 6 m or 7 m in length
- Very low starting currents - FreshJet 2200 with Soft Start
- Air diffuser with two adjustable air flows
- LED lighting, remote control



Dometic FreshJet 3200

Ideal for vehicles of over 8 m

For a full range of rooftop or underbench air conditioners please visit:
www.dometic.co.uk/air-conditioners

 **Dometic**



OFFICIAL
SUPPLIERS
TO SWIFT



**MADE IN
BRITAIN**



**SPECIALISED
COVERS**

THE ULTIMATE IN PROTECTION & PRESERVATION

For over 35 years, we've been the market leader in supplying innovative solutions in caravan protection.

British designed and manufactured we're proud of our heritage and it shows in the unrivalled quality of our caravan covers and towing protectors.

Call us on 01943 864 646 Email info@specialisedcovers.com
Visit specialisedcovers.com

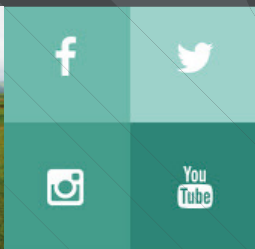

Members discount: **SWO2016**

JVC

Entertainment for your journey

The versatile KD-R464 car stereo is sure to liven up your journey. Whether it's your favourite compilation on an Android or Apple device, simply connect via the front USB or AUX inputs to enjoy your favourite tracks, or scan the airwaves to catch up with the latest news.



MOBILE ENTERTAINMENT
<http://uk.jvc.com>





PERFECT ADDITIONS TO YOUR CARAVAN



Aventa Comfort Rooftop Air Conditioner

- Efficient: high performance, low power consumption
- Lightweight
- Convenient: even air distribution, quiet night-time setting



Truma Mover® XT

- Up to 20 kg weight saving over competitor systems
- Revolutionary design: the Mover® XT is the first mover to use high efficiency brushless DC motors allowing the use of a smaller, lighter battery
- Absolute reliability and security



Scan here
to view the
Mover® XT
movie

www.trumauk.com

More comfort on the move

THETFORD
Loving leisure

Take care, take Thetford



World's best selling toilet additives.
Visit us at www.thetford-europe.com

POWER YOUR GETAWAY



Product registered and

VERIFIED

www.thencc.org.uk



Start your adventure with Yuasa

When it comes to batteries, Yuasa are number one for high quality, reliability and performance.

Designed for caravans and motorhomes, our maintenance free leisure range provide a long service life and also incorporate enhanced safety features.

So the next time you're ready to getaway, you can rely on Yuasa to give you the freedom.

Find your nearest stockist at:

www.yuasaeurope.com



YUASA

The world's leading battery manufacturer A  **GS YUASA** Group Company



Thule Excellent
Standard



Thule Excellent
Short

➤ Thule Excellent 100% innovation. Pure design



• 2 bikes

• Weight: 10.6kg

• Max. loading weight: 50kg

• Max. bike weight: 30kg

• Perfect for e-bikes

Contact us: infoRV@thule.com

Bring your life
thule.com

Oyster[®]

Premium

New!

ten Haaft – A GERMAN COMPANY WITH 25 YEARS OF TRADITION

- Oyster[®] Premium – the „classic“ in combination with the new „Oyster[®] TV“ – devices
- Perfect networking – both systems are controlled with only one System Remote Control*
- Everything from a single source!
- 3 years warranty



POWERED BY **astex**



*System Remote Control only available for Premiumrange

www.oystersat-tech.co.uk

Oyster[®]
Sat-Tech Ltd.

A ten Haaft Company

Oyster Sat-Tech Ltd. · Unit 5, Hemploe Business Park Hemploe Road, Welford Northants, NN6 6HF

Tel.: 0044 1858 575 928 · Fax: 0044 1858 575 028 info@oystersat-tech.co.uk

Anytime. Anywhere.

The 2017 Swift Challenger

Now available with Alde heating –
more than just an option, a necessity.



Way back in 1994 Swift chose Alde heating systems to help make their caravans and motorhomes feel more like home, so it's no surprise that Swift owners have had a lot to smile about ever since.

Proudly made in Sweden since 1949, Alde delivers the quietest, most comfortable caravan heating for the great explorers of the world, and we keep on innovating. We even test Swift caravans down to -15 to ensure you stay cosy no matter where your journey takes you.

Feel the difference

alde.co.uk

The Alde logo consists of three slanted parallel lines in red and black, followed by the word "Alde" in a bold, black, sans-serif font with a registered trademark symbol.

STEP INTO MORE CONTROL

At the Swift Group we're continually looking for ways to enhance your enjoyment of the outdoors. Swift Command is a real innovation designed to make your touring experience even more carefree.

Swift Command technology includes a smart LCD control panel that has enhanced control panel functions. There is also an exciting, free downloadable 'app' that links to the Swift Command unit, so you can be in control from the comfort and convenience of your mobile device.

Swift Command is now available across the entire range.



Head to the Apple or Android store and search for 'Swift Command'.



LIGHTING

Create just the right ambience onboard with easily adjustable lighting settings.



LOCATION AND REMOTE FEATURES

Connect to your leisure vehicle from any where to view its systems information and location. Conveniently control and monitor your onboard services when away from your vehicle.



WATER

Keep an eye on your precious water levels so you know in good time when to top-up.



POWER

Track your energy use and manage your batteries for efficient use of your all important power services.



HEATING

Activate whilst out exploring and enjoy the warmth when you get back.



**CONNECT
DIRECT**

STEP INTO CONNECT DIRECT

WHAT IS CONNECT DIRECT?

Connect Direct is an online system which personalises each customer's experience of owning their caravan. The system is now available across the entire range.

HOW DOES IT WORK?

Once you have logged on and created your profile, you will be able to access a whole host of information, specific to your caravan. In addition you will be able to have a direct line into the retail team, with the launch of a live chat facility.

Should a problem occur, you will be able to report a fault to us directly, enabling us to react

quickly and work together with your dealer to take the problem away from you the owner and resolve the issue as quickly as possible.

Product upgrades and notifications will be sent via Connect Direct keeping you up to date over the coming years. This online system provides a direct route for you into the Swift Group, and enables us to provide you with proactive Customer Service support, enhancing your experience.

Connect Direct is in addition to the traditional methods of contacting us.

The key benefits of Connect Direct are:

- Access to information 24/7
- Ability to report faults directly to us
- Product upgrades and notifications
- Live chat direct into our experienced retail team
- Upload service history records
- Service history reminders

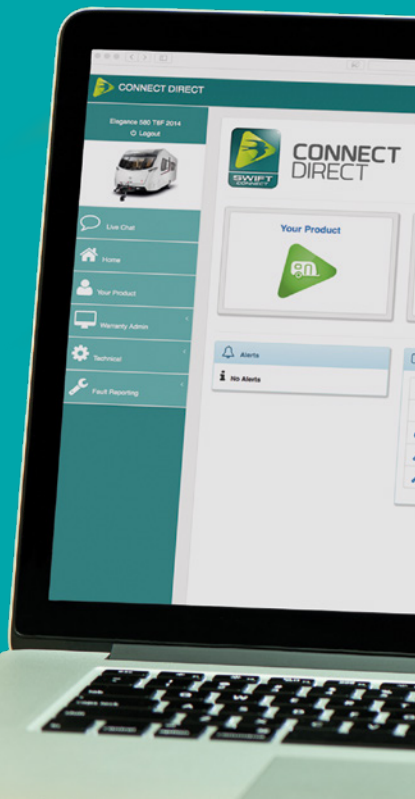

**CUSTOMER
SERVICE**



TECHNICAL



REPAIRS



**CUSTOMER
CHAT**

Dear owner

Thank you for deciding to buy one of our new caravans.

We are sure you will enjoy many happy hours in it and we hope the information and hints in this handbook will heighten your enjoyment.

The handbook has been designed to give you a general guide to the care, use and maintenance of your caravan. Whether you are a new or an experienced caravanner the hints will help to protect your investment.

The information contained will answer most of your queries, but if there are any aspects which are not covered please consult your appointed dealer. We would suggest you make a note of your dealers name and contact information below.

Throughout the season, specifications and equipment details contained within this handbook may change. Please refer to our online handbooks (www.swiftgroup.co.uk) for the most up-to-date version of your handbook.

Customers should note that all caravans are supplied with two handbooks, the User Handbook which contains general information for the use and care of your product and the Technical Handbook, which contains technical information, weights and dimensions of your product.

Dealer Name:

.....

First Service Due:

.....

Telephone Number:

.....

Dealer Contact Sales:

.....

E-mail:

.....

Dealer Contact Parts:

.....

Serial Number:

.....

Dealer Contact Service:

.....



Swift Talk

Swift Talk is the central forum for the Swift community online. A place for all those united in their love of caravanning, motorhomes, holiday homes and touring in general, to share their experiences, meet new friends and find out a world of information on how to enjoy their touring lifestyle.

The site is packed full of features that actively encourage members, not only to liaise with the Swift Group via the forums, but also interact with each other through publishing their own content, uploading and sharing photos and video, and even posting their own blogs for the community to follow.

Swift Talk is the first place to learn about new product launches, events and Swift Group news, it's also the first place customers can go to as a quick reference to frequently asked questions or to actively take part in the forums; providing valuable feedback on Swift Group products and customer service.

The online community can even be used to create your own groups, perfect for Owners' Clubs, dealers and exhibitors to attract new

members, publicise and build awareness for upcoming events, rallies and shows.

Anyone who owns, uses, or is thinking of buying a Swift Group caravan, motorhome or holiday home, or would just like to be part of the growing Swift community is actively encouraged to sign up, create their own content, and start talking!

Just visit www.swift-talk.co.uk and become part of a unique online experience.

Warranty	5
Towing code	13
Safety & security	35
Services	53
Electrics	77
Fitted equipment	105
Maintenance	221
Useful information	259
Index	266

WARRANTY INFORMATION

Warranty and guarantee cover	6
Change of ownership	8
Swift Connect Direct.....	8
What to do if you require assistance	8
Supplier contacts	9
Touring caravans - annual service/inspection record	10
Annual service / inspection record stamps	11

All the illustrations and descriptive matter in this handbook are intended to give a general idea of the caravan. Changing market and supply situations and our policy of continuous product development may prevent us from maintaining the exact specifications detailed in this handbook. We therefore reserve the right to alter specifications as materials and conditions demand.

Dealers are not agents of Swift Group Limited ("Swift") and have absolutely no authority to bind the manufacturer by any express or implied undertaking or representation.

Your caravan has three warranties:

SuperSure Warranty

For all parts or fittings of your caravan other than the body shell, Swift will repair (or at its option, replace) any defective parts or fittings for 3 years from the date of purchase (or hire purchase) subject to conditions, terms and exclusions below.

Body Shell Warranty

For the body shell, Swift will repair (or at its option, replace) any defects with the body shell for 6 years from the date of purchase (or hire purchase), subject to the conditions, terms and exclusions below.

Extended Body Shell Warranty

For the first owner, Swift will repair (or at its option, replace) any defects with the body shell for 10 years from the date of purchase (or hire purchase), subject to the conditions, terms and exclusions below.

Conditions

1. You must ensure that your caravan has had an Annual Service (see clause 2 below) within 90 days before or 60 days after each anniversary of the original date of purchase. In order to preserve your SuperSure Warranty, the third Annual Service must be carried out before the expiry of the 36 month period from the original date of purchase. In order to preserve your Body Shell Warranty, the sixth Annual Service must be carried out before the expiry of the 72 month period from the original date of purchase. In order to preserve your Extended Body Shell Warranty, the tenth Annual Service must be carried out before the expiry of the 120 month period from the original date of purchase. If you have not performed an Annual Service then Swift will not be obliged to perform any work under the applicable warranty. Original VAT invoices must be retained as proof that Annual Services have been carried out.
2. The Annual Service must be carried out in accordance with the requirements in this handbook. You will be responsible for any charges made for an Annual Service. If the Annual Service is performed by an authorised Swift Group Service Centre then Swift warrants that the Annual Service has been performed correctly. If the Annual Service is performed by an unauthorised repairer or service centre then if the Annual Service has not been performed in accordance with the requirements in this handbook and/or work has been performed on your caravan that is defective or faulty, then Swift will not be obliged to perform any work under this Warranty (insofar as it relates to defective or faulty work or defective Annual Service).
3. All new caravans must be registered with Swift within 6 weeks of purchase as new.
4. The benefit of the SuperSure Warranty and Body Shell Warranty may be transferred to a new owner if the caravan is re-sold, provided that the caravan has been serviced in accordance with the requirements of this handbook, and details of the change of ownership have been supplied to Swift using the change of ownership form set out in this handbook as soon as reasonably practicable after the change.
5. The benefit of the Extended Body Shell Warranty is non transferable to new owners and applies only to the original registered owner.
6. If any repairs are identified as being necessary during an Annual Service or

otherwise, Swift will only pay for Warranty work performed by an authorised Swift Group Service Centre. The caravan must be made available to an authorised Swift Group Service Centre within 6 weeks of the date the repair need was identified for the work to be carried out. The cost of transporting, towing or moving the caravan by any means to or from the place of repair is the responsibility of the owner.

7. The SuperSure Warranty, the Body Shell Warranty and/or the Extended Body Shell warranty only apply to caravans purchased and used primarily within the UK.

Terms

8. The Body Shell Warranty and Extended Body Shell Warranty cover any defect with the panels and seams of the caravan. This includes body leaks, delamination of panels or floor, water ingress through any permanently sealed seam joints.

9. The SuperSure Warranty will cover in the first 12 months any defect other than those specified in the Exclusions below.

10. In years 2 and 3 of the SuperSure Warranty, the Warranty will only cover any defect with the following components:

- **Chassis Components:** all chassis members, including corner steadies, overrun device, axle and braking system (excluding brake drums and shoes)
- **Electrical System:** PSU, battery charger, Smart Command and interior lighting units (excluding bulbs).
- **Water System:** water heater, fresh water tank, water pump, water gauges, taps and shower head.
- **Cooker:** the cooker unit including grill, oven, burners, igniter and flame failure device.
- **Refrigerator:** gas igniter, flame failure device, door seal condenser, gas control valve, 12V and 230v heater elements, gas thermostat, 230v thermostat and 230v temperature control switch
- **Cassette Toilet:** the cassette toilet (excluding seals, valves and glands)

- **Heating System:** thermostat, motor, switches, control unit, gas heater, flame failure device and igniter (excluding ducting and fittings)

- **Windows:** the functionality of the opening and closing system (stays, handles and catches) and a warranty against the cracking of the acrylic. Excludes fading.

- **Upholstery:** zips, seams and colour fastness

In years 2 and 3 of the SuperSure Warranty, any defect specified in the Exclusions will not be covered.

Exclusions

11. Swift shall not be liable under this Warranty for any defect related to or arising from the following:

- The failure of a component for reasons of fair wear and tear;
- Damage resulting from freezing, fire, overheating or accidents (whether caused by the user or a third party);
- Misuse of any component;
- Normal deterioration, corrosion, intrusion of foreign or harmful bodies, lack of servicing or negligence of any person other than Swift which causes stoppage of or impairment to the function of any component of the caravan;
- Replacement of parts which have reached the end of their effective working life because of age and/or usage;
- Cleaning or adjustment of any assemblies;
- Cosmetic finishes to kitchen sinks, cooker tops, vanity units, shower trays.
- Damage caused by any abrasive cleaners
- Issues related to condensation in normal use;
- Routine maintenance items which are part of the annual service including brake shoes, one shot nuts, lubricants, AKS pads, rubber gas hose, the cleaning of the heater and fridge flues, the replacement of gas jets, the resealing and/ or replacement of shower room sealant, and the adjustment and lubrication of locks.

ASSISTANCE

12. In addition to the exclusions above, in years 2 and 3 of the SuperSure Warranty Period, Swift Group Limited shall not be liable under this Warranty for any defects related to:

- Alloy wheels: after 24 months from date of purchase, this excludes wear and tear, (tyres & valves excluded).
- Wall and Roof GRP sheeting material: after 24 months from date of purchase only

WARRANTY INFORMATION

Swift shall also not be liable under the SuperSure, Body Shell and Extended Body Shell Warranties if the Caravan has been neglected, misused, modified or use for hire or reward or if the identification marks (chassis/VIN numbers) have been removed or defaced. The caravan will be deemed to have been neglected if it has not been serviced and maintained as stated in this handbook or any repairs being identified as necessary at an Annual Service or by a Swift Group Service Centre have not been carried out in a reasonable time.

You have legal rights under UK law governing the sale of consumer goods. These warranties do not affect your legal rights.

The name and address of the warranty and Guarantee provider is: Swift Group Limited, Dunswell Road, Cottingham, East Yorkshire, HU16 4JX. In the unusual event that a fault develops and you need to claim under Body Shell Warranty or the SuperSure Warranty, your first contact should normally be made through the dealer from whom the caravan was purchased. If this is not feasible then a claim may be dealt with by a different authorised Swift Group Service Centre, please contact the Swift Group Customer Service Department on 01482 875740 or enquiring on our website: www.swiftgroup.co.uk directly for details.

Change of ownership

You can transfer the remainder of any 3 year 'Supersure warranty' and the 6 year 'body shell' warranty, details of how to do this can be found at the rear of this handbook.

The 'Extended Body Shell Warranty' is non transferable.

Swift Connect Direct

You have access to a new online system which is specific to your new caravan. A password will be issued to you, to enable you to interact with us. To access the system, called 'Swift Connect Direct', your initial log in details will be emailed to you once your supplying dealer has registered your ownership with us. Please log in and create your own profile. Should you have issues with accessing Swift Connect Direct, please contact our Customer Services Team.

What to do if you require assistance

We are confident that you will enjoy many happy holidays. However, should you have an enquiry or require assistance with a problem, we hope that this guide will be of assistance to you.

If you have a problem, or enquiry with regards to your new caravan, please follow these steps:

1. Check the Owners Handbook, paying particular attention to the fault finding advice at the back of the book.
2. Contact your supplying dealer for assistance.

If you need to contact the Swift Group, please be aware of the following:

1. When contacting Swift Customer Service, please quote your name, postcode and serial number of your caravan.
2. In most instances, the Customer Service Team will involve your dealer in resolving the issue you are experiencing.
3. Check our website www.swiftgroup.co.uk and enter the Owners section which provides answers to frequently asked questions and how to contact us.
4. If you are contacting the company by email, letter or fax, the Customer Service Team will respond to you within five working days from the date of receiving the correspondence.

5. If you are calling the Customer Service Team, please avoid where possible, Mondays and lunch times.

6. Please be aware that the Swift Group cannot send parts direct from the factory. In all cases, without exception, your dealer must place the order for you.

Supplier contacts

A number of Swift Group suppliers manage their own Technical and Warranty related queries. Where a customer has a question relating to a product manufactured by a company listed below, we would advise that the first contact should be directly with them.

SARGENT

Sargent Electrical Services

Unit 39, Tokenspire Business Park,
Beverley, East Yorkshire, HU17 0TB
Phone: 01482 678981
Fax: 01482 678987
E-mail: support@sargentltd.co.uk

AL-KO

AL-KO Kober Limited

South Warwickshire Business Park
Kineton Road, Southam,
Warwickshire, CV47 0AL
Fax: 01926 818562
Email: mail@al-ko.co.uk

Truma

Truma UK Ltd.

Park lane, Dove Valley Park,
South Derbyshire, DE65 5BG
Phone: 01283 586020
Fax: 01283 586029
technical@trumauk.com

THETFORD Corporation

Thetford Ltd.

Unit 6, Brookfields Way, Manvers,
Dearne Valley, Rotherham,
South Yorkshire, S63 5DL
Phone - 0844 997 1960
Fax - 0844 997 1961
Email - info@thetford.eu

Alde

Alde International (UK) Ltd

Huxley Close, Park Farm South,
Wellingborough, Northants, NN8 6AB
Phone: 01933 677765
Fax: 01933 674975
Email: info@alde.co.uk

Dometic

Dometic (UK) Ltd

Dometic House, The Brewery,
Blandford St Mary, Dorset, DT11 9LS
Phone: 0844 626 0133
Email: technical@dometic.co.uk

Touring caravans - annual service/inspection record

In order to comply with the warranty, you must have your caravan inspected and serviced at least once per year.

We highly recommend that you have your Touring Caravan serviced by a Swift Group Approved Service Centre who have direct access to our online Customer Service system, Connect. This system provides them with the ability to order approved parts and ensure that any product upgrades which may be available for your Touring Caravan can be offered to you and carried out as part of the service. In the unfortunate event that an issue requires attention under warranty then a Swift Group Approved Service Centre are able to submit a warranty claim to the Swift Group for processing, and deal with the issue for you from start to finish. All of our Swift Group Approved Service Centres are provided with up to date technical information and have access to current repair methods giving you peace of mind that any defect has been repaired effectively.

It is important that the Owner's Handbook is stamped on the appropriate page by the authorised Swift Group Service Centre. Failure to do this will invalidate the warranty and the transfer of the warranty on the change of ownership.

The inspection should take approximately two to four hours and will cover the areas dealt with in the annual service check list. Any areas requiring service and/or maintenance will be highlighted by your dealer and we recommend that you authorise any necessary work to be carried out.

Note: It is essential, to validate the warranty, that an annual inspection be carried out by an authorised Swift Group Service Centre covering the items listed.

1. Damp and lamination test. This is a visual inspection of bodywork and seals.
2. Coupling head and breakaway cable.
3. Jockey wheel.
4. Chassis and chassis to body security.
5. Corner steadies.
6. Tyres and tyre pressures.
7. Torque wheel nuts.
8. Brake rods and linkages.
9. Hub bearings, brakes and brake shoes.
10. Handbrake operation and performance.
11. Suspension and shock absorbers (if fitted).
12. 13 pin plug and cables.
13. Road lights, wiring and reflectors.
14. Internal lights and 12V DC system.
15. Water heater - gas and 230V AC (if fitted).
16. Hob, grill and oven (if fitted).
17. Refrigerator 230V AC, 12V DC and gas.
18. Gas system.
19. Water pump, taps and water system.
20. Mains 230V AC system.
21. Windows and fittings.
22. Smoke alarm and battery.
23. Roof lights.
24. Furniture hinges/stays etc.
25. Exterior locks and hinges.
26. Grab handle security.
27. All internal vents.
28. Oil seals.
29. Blinds and fly screens (if fitted).
30. Carbon Monoxide detector.

<p>Annual service / inspection record stamps</p> <p>Caravan model:</p> <p>Year:</p> <p>Chassis Number:</p>	<p>1st service</p> <p>Date:</p> <p>Dealer's Stamp</p> <p>We certify that an annual service has been carried out in accordance with the handbook.</p>
<p>2nd service</p> <p>Date:</p> <p>Dealer's Stamp</p> <p>We certify that an annual service has been carried out in accordance with the handbook.</p>	<p>3rd service</p> <p>Date:</p> <p>Dealer's Stamp</p> <p>We certify that an annual service has been carried out in accordance with the handbook.</p>
<p>4th service</p> <p>Date:</p> <p>Dealer's Stamp</p> <p>We certify that an annual service has been carried out in accordance with the handbook.</p>	<p>5th service</p> <p>Date:</p> <p>Dealer's Stamp</p> <p>We certify that an annual service has been carried out in accordance with the handbook.</p>
<p>6th service</p> <p>Date:</p> <p>Dealer's Stamp</p> <p>We certify that an annual service has been carried out in accordance with the handbook.</p>	<p>7th service</p> <p>Date:</p> <p>Dealer's Stamp</p> <p>We certify that an annual service has been carried out in accordance with the handbook.</p>

SERVICE INSPECTION

<p>8th service</p> <p>Date: Dealer's Stamp</p> <p>We certify that an annual service has been carried out in accordance with the handbook.</p>	<p>9th service</p> <p>Date: Dealer's Stamp</p> <p>We certify that an annual service has been carried out in accordance with the handbook.</p>
<p>10th service</p> <p>Date: Dealer's Stamp</p> <p>We certify that an annual service has been carried out in accordance with the handbook.</p>	<p>11th service</p> <p>Date: Dealer's Stamp</p> <p>We certify that an annual service has been carried out in accordance with the handbook.</p>
<p>12th service</p> <p>Date: Dealer's Stamp</p> <p>We certify that an annual service has been carried out in accordance with the handbook.</p>	<p>13th service</p> <p>Date: Dealer's Stamp</p> <p>We certify that an annual service has been carried out in accordance with the handbook.</p>
<p>14th service</p> <p>Date: Dealer's Stamp</p> <p>We certify that an annual service has been carried out in accordance with the handbook.</p>	<p>15th service</p> <p>Date: Dealer's Stamp</p> <p>We certify that an annual service has been carried out in accordance with the handbook.</p>

Caravan towing code	14
Caravan terms	14
Towing vehicle terms	16
Measurement of nose weight	16
Type of driving licence held	17
Glossary & checklist	17
Useful memory aid	19
Preparing for the road	20
Tyre maintenance	23
The tyre law	24
Hitch up for AKS3004 stabiliser and pre tow check list	24
13 Pin socket	27
Towcar electrics.....	28
Breakaway cables	29
Mirrors	30
Moving off	31
Reversing	31
Speed limits	31
Caravan handling	31
Motorway driving	31
AL-KO spare wheel carrier tips	32
Changing a wheel	32
Wheel bolt tightening	32
Jacking points	33
Stopping on a hill	33
Arrival on site	33
AKS 3004	34
Exterior Door	34

TOWING CODE

Caravan towing code

This Code of Practice contains recommendations jointly reviewed and agreed by the following organisations:

The National Caravan Council
 The Caravan Club
 The Camping and Caravanning Club
 The Caravan Writers Guild
 The Department for Transport

Scope of the Code

The Code applies to all trailer caravans of maximum laden weight not exceeding 3500 kg, overall width not exceeding 2.55m and overall length not exceeding 7m, excluding the drawbar and coupling.

This is legally the maximum size of trailer that can be towed by a motor vehicle with a maximum gross weight of less than 3500 kg.

Caravan terms

Empty weight:

The empty weight of the caravan includes all loose items supplied by Swift e.g electric hook up cable, kit bag, entrance step, portable waste tank & central heating fluid (where applicable)

Mass in Running Order:

The mass of the caravan equipped to the caravan manufacturer, standard specification.

The MRO comprises the empty weight of the caravan and includes an allowance for gas.

Note: The mass of the caravan in running order contains provision for the masses of liquids, gas etc. (see Mass in Running Order in the Technical Handbook). Part of this provision can also be utilised as additional payload, if for example, you wish to travel with no gas cylinders.

Maximum User Payload:

The maximum allowable weight to be put into the caravan whilst it is being towed. This is made up of the personal effects and the optional equipment payloads.

The user payload is the difference between the Maximum Technically Permissible Laden Mass and the Mass in Running Order.

The Mass in Running Order + Personal Effects + Optional Equipment = Maximum Technical Permissible Mass or MRO + PE + OE = MTPML

Personal Effects

Those items which a user can choose to carry in a caravan.

Note: The Personal effects payload includes an allowance of 20kg for a leisure battery.

Optional Equipment

Items made available by the manufacturer over and above the standard specification of the caravan for factory fitted options.

Maximum Technically Permissible Laden Mass (Lower Limit):

The fully laden mass of the caravan in the manufacturers standard specification which is stated in the publications, technical handbooks, brochures and weight plate and used for car matching.

Maximum Technically Permissible Mass (Upper Limit):

The mass takes into account specific operating conditions including factors such as the strength of materials, loading capacity of tyres, etc.

Payload Definition

The method of calculating the Mass in Running Order (MRO) and user payload figures are in line with European Vehicle Directives.

Allowances for essential equipment is now contained within the MRO of the caravan, as per NCC Code of the Practice (CoP) 304. This includes the following:

LPG 1 x cylinder = 10kg

The MRO is calculated with the fresh water tank empty (where fitted).

*Weights are typical figures and are dependant on specification.

Note: If you travel with water in the fresh water tank, the payload will be reduced accordingly.

The leisure battery is considered to be included in the personal effects and an allowance of 20kg has been made for this. Items fitted at the point of manufacturer (hook-up cable, plastic steps, waste containers, etc.) are included within the vehicle MRO.

⚠ WARNING: Under no circumstances should the maximum technically permissible laden mass (MTPLM) be exceeded.

Upgrading of maximum technically permissible laden mass:

The lower (or standard) MTPLM is quoted in the Technical Handbook, in brochures and on the caravan weight plate. However, in some cases it may be possible to increase this to a higher (upper) MTPLM. (See Technical Handbook for details).

If extra user payload is required, an upgrade maybe available (model dependant), this must be requested via your dealer and is chargeable.

If required you will be issued with the following:

- (i) New weight plate giving upgrade weight details.
- (ii) New NCC certificate (declaring the upgraded MTPLM)

- (iii) Manufacturers letter confirming the upgrade for that Vehicle Identification Number.

Note: Tyre pressures may increase when upgrading the MTPLM.

Nose weight:

The vertical weight transferred to the towing vehicle through the coupling head.

Notes:

- (i) When measuring the noseweight it is important that the caravan is fully loaded. Do not place extra items indiscriminately into the caravan after this adjustment has been made.
- (ii) The caravan is intended to be towed slightly nose heavy. The nose weight can be adjusted by distribution of the load within the caravan. The nose weight should be approximately 5-7% of the actual laden weight (but not greater than the hitch capacity) and at the same time suit the towing vehicle. See section on Measurement of Nose Weight.
- (iii) It is not recommended that you tow with just a battery, spare wheel and gas bottles as this may exceed the permitted nose weight. Additional payload must be placed behind the axle to compensate for this.

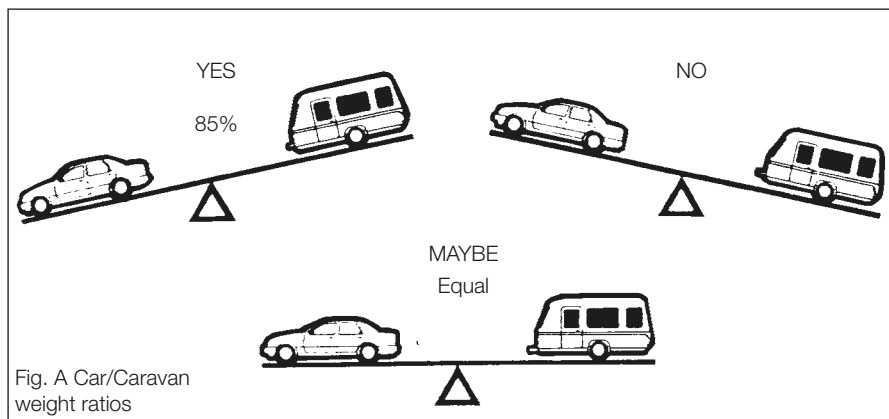

Fig. A Car/Caravan weight ratios

TOWING VEHICLE TERMS

Towing vehicle terms**Kerb weight****(Mass of Vehicle in Running Order):**

The weight of the towing vehicle as defined by the vehicle manufacturer. This is normally with a full tank of fuel, with an adequate supply of liquids incidental to the vehicles propulsion, without driver or passengers, without any load except loose tools and equipment with which the vehicle is normally provided and without any towing bracket.

Caravan to Towing Vehicle Weight Ratio:

The towing vehicle to caravan weight ratio can be determined by calculation and is equal to:

$$\frac{\text{Actual laden weight of caravan}}{\text{Kerb weight of towing vehicle}} \times 100\%$$

The law requires that caravans & their towing vehicles & the loads they carry must be in such a condition that no danger or nuisance is caused.

(Regulation 100 of the Road and Vehicles [Construction and Use] Regulations 1986).

Note: The towing vehicle manufacturer's limit is, in some cases, less than the kerb weight.

Mass in Running Order:

Caravanners can use a public weigh bridge to establish the mass in running order.

Note: Weigh bridges have varying weight tolerance levels.

Maximum Permissible Towing Mass:

The weight defined by the vehicle manufacturer as being the maximum that the vehicle is designed to tow.

Train Weight (Combination Weight):

The maximum combined weight of the towing vehicle and trailer combination as specified by the towing vehicle manufacturer.

Measurement of nose weight

Nose weight may be measured using a propriety brand of nose weight indicator. Such equipment is obtainable at your Caravan Dealer.

Note: These indicators have a varying tolerance level and may not be accurate.

Another simple method is to use bathroom scales under the coupling head with a piece of wood, fitted between the coupling head and the scales, of such length that the caravan floor is horizontal with the jockey wheel raised clear of the ground. (Fig. A)

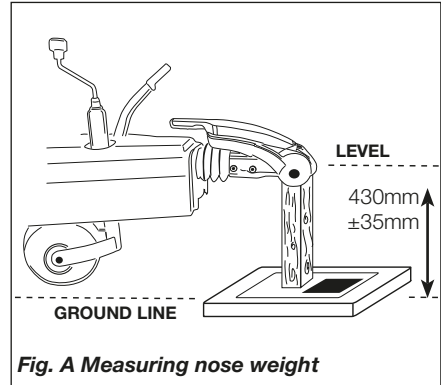

Fig. A Measuring nose weight

Nose weight can be adjusted simply by distribution of weights in the caravan.

Always lower jockey wheel before entering the caravan and then raise before measuring again. (See Loading).

Note: The height of the towball on the towing vehicle, when laden, is also critical.

⚠ WARNING: Do not lift the coupling head by hand when hitching the caravan to the car. Always raise and lower the coupling head by winding the handle on the jockey wheel up and down.

Driving licence

If you passed your car test before 1st January 1997 you are generally entitled to drive a vehicle and trailer combination up to 8,250kg maximum authorised mass (MAM). This is the weight of a vehicle or trailer including the maximum load that can be carried safely when it's being used on the road.

You can also drive a minibus with a trailer over 750kg MAM.

If you passed your driving test after 1st January 1997 and have an ordinary category B (car) licence, you can:

- Drive a vehicle up to 3,500kg MAM towing a trailer of up to 750kg MAM
- Tow a trailer over 750kg MAM as long as the combined MAM of the trailer and towing vehicle is no more than 3,500kg

For anything heavier you need to take a category B+E driving test.

From 19th January 2013, drivers passing a category B (car) test can tow:

- Small trailers weighing no more than 750kg
- A trailer over 750kg as long as the combined weight of the trailer and towing vehicle is no more than 3,500kg MAM

If you want to tow a trailer weighing more than 750kg, when the combined weight of the towing vehicle and trailer is more than 3,500kg, you'll have to pass a further test and get B+E entitlement on your licence.

Glossary & checklist

Awnings - Can consist of just a simple top sheet but may extend to a five sided frame tent attached to the side of the caravan.

Fire blanket - approved to BS 6575 is ideal for dealing with 'fat pan' fires.

Fire extinguisher - It is strongly recommended that a fire extinguisher is carried in the caravan. (For suitable types see Safety and Security).

Gas bottles - Bottled L.P. gas is the most convenient portable source of fuel. Ideally two bottles are required for a constant supply.

An initial deposit is payable on each cylinder. We recommend the use of 6kg Calor Light Propane bottles. One position for use and one for storage only. (For detailed information see Services - Gas).

Jack - A suitable jack is essential (screw, scissor, side mounted or air jack type). Many car jacks are unsuitable. Ensure the lifting capacity of the jack is suitable for your caravan.

Levellers - Levellers help level the caravan from side to side before unhitching. Proprietary products can be purchased from your caravan dealer and need to be positioned as indicated by a spirit level.

Spare Wheel - It is always advisable to carry a spare wheel with your caravan.

Spirit Level - A spirit level is extremely useful when siting the caravan.

Stabiliser - Stabilisers help to dampen the side to side movement of the caravan.

Torque Wrench - A torque wrench is the only way that the exact recommended torque can be achieved for wheel nuts and bolts. (See Preparing for the Road).

GLOSSARY AND CHECKLIST

Towing Bracket - Never use cheap alternatives, obtain one manufactured by a reputable company complying with the relevant standards.

Any light passenger vehicle registered in the UK on or after August 1st 1998 will require a type approved towbar and towball (to 94/20/EC or UN ECE R55). Failure to fit a homologated towbar and towball could result in a prosecution and invalidation of your insurance cover. Always check with your car manufacturer or towbar manufacturer if in doubt.

Wooden Blocks - Wooden blocks typically 25cm square and 2cm thick are ideal for placing under corner steadies and jockey wheel when the ground is uneven or soft.

Water Containers - Two containers are required, one to carry fresh water to the caravan and one for waste water, which needs to be disposed of properly. Several types are available including jerry cans, Aquarolls, wastemaster, etc .

13 Pin Socket - One socket fitted to the car to accept corresponding plugs from the caravan this energises the road lights and caravan auxiliary circuits.

12 Volt Battery - A deep cycling, heavy duty rechargeable leisure type battery should be purchased to provide back-up power for lights and other electrical appliances. (See Battery). The securing arrangements for the battery compartment require a leisure battery complying with EN 60095-2 in particular those with ledges for fastening to the lower edge of the long sides. The maximum battery size that can be fitted is 225mm high, (including terminals) x 175mm deep x 353mm wide. The depth and width dimensions include the rim around the bottom used for securing the battery.

Note: Batteries that are not foot mounted, ie. without a rim, can still be fitted, but check first that they will fit within the battery box and can be secured before purchasing.

⚠ WARNING: Your caravan dealer should be consulted if additional equipment is to be fitted as strong points may or may not be provided in the design.

Caravan motor movers

The design and fitment of a caravan motor mover shall be in accordance with the NCC Code of Practice 305 and you should ensure you receive a signed installation certificate of compliance from the installer.

Failure to do so may invalidate your warranty.

Note: Fitting additional equipment, such as a motor mover will reduce the caravan allowable payload.

Note: The fitting of a motor mover may require a larger capacity battery fitting.

Note: If a towing cover is fitted, care should be taken not to obscure lights, reflectors and protect against rubbing or damaging the bodywork.

Useful memory aid**Car**

External mirrors
 Fire extinguisher
 Jack
 Petrol can
 Spare bulbs
 Spare keys
 Spare wheel
 Tool kit
 Towball cover
 Tyre pressure gauge
 Warning triangle
 Tyre pump
 Hi-Vis tabards
 Headlight stickers/Beam
 benders
 Breathalyser kit (some Euro
 countries)

Caravan

Awning pegs and poles
 Awning ground sheet
 Bucket
 Corner steady brace
 Corner steady pads
 Coupling lock
 Door mat
 Fire blanket
 Fire extinguisher
 Fresh water container
 Gas cylinders
 Jack
 Levelling boards
 Mallet
 Site/caravan mains lead
 Spare bulbs -
 (Mandatory in E.C.)
 Spare 12v fuses
 Spare high pressure gas hose
 Spare wheel
 Spirit level
 Toilet fluid
 Waste water container
 Wheel brace

Personal

After sun cream
 First Aid Kit
 Flannels
 Hairbrush and comb

Make up. etc.
 Raincoats
 Toothbrush
 Toothpaste
 Scissors
 Shampoo
 Shaving kit
 Shoe cleaning kit
 Soap
 Sun tan oil
 Wellington boots

Domestic

Adhesive tape
 Air freshener
 Aluminium foil
 Ashtrays
 Bedding
 Bin liners
 Binoculars
 Bottle opener
 Breadboard
 Brush and dustpan
 Butter dish
 Camera
 Carving knife
 Chairs
 Clock
 Clothes brush
 Clothes line
 Coat hangers
 Coolbox
 Colander
 Crockery
 Cruet
 Corkscrew
 Cutlery
 Dish cloth and brush
 Dusters and polish
 Disposable cloths
 Egg cups
 Floor cloth
 Fly spray
 Food
 Food mixer
 Frying pan
 Glasses
 Grill pan
 Jugs
 Kettle
 Kitchen roll
 Kitchen tools

Matches
 Measuring jug
 Milk jug
 Mixing bowl
 Needles and thread
 Oven gloves
 Pegs
 Piezo Gas lighter
 Potato peeler
 Radio
 Rubbish bin
 Saucepans
 Scissors
 Sieve
 Sugar bowl
 Shopping bags
 Sleeping bags
 Tea pot
 Tea strainer
 Tea towels
 Table cloths
 Table mats
 Television
 Tin opener
 Tissues
 Toilet paper
 Torch
 Towels
 Toys & Games
 Vacuum cleaner
 Washing up bowl

Documents

Bank and credit cards
 Caravan Certificate
 Cheque book
 CRIS document
 Driving licence
 Green Card
 Insurance (some Euro
 countries)
 Maps and guides
 Money
 MOT Certificate
 Vehicle Registration
 Documents

PREPARING FOR THE ROAD

Preparing for the road**Pre-load checklist**

⚠ WARNING: Never enter the caravan without first lowering the four corner steadies with the brace provided.

Before loading check:

- loose articles are stowed securely. Do not stow tins, bottles or heavy items in overhead lockers prior to towing.
- all lockers and cupboard doors are closed and secured, including the bathroom door.
- all bunks are secure.
- ensure shower door is secure
- all rooflights are closed and secured.
- main table is stored in its transit position.
- television aerial is lowered and locked in travel position, where relevant
- fridge is on 12V operation and door lock is set.
- all windows and service doors are fully closed and latched. Never tow with windows on night setting. Leave all curtains and blinds open to aid rear visibility.
- gas cylinders are correctly positioned, secured and turned off, unless using en route heating.
- battery is secure and mains connecting cable is disconnected and stowed.
- Exterior door is closed and locked

⚠ WARNING: Turn off gas appliances except en route heating (if fitted).

⚠ WARNING: Do not travel with televisions or microwaves in overhead lockers unless the appliance was supplied fitted to your caravan by the manufacturer.

⚠ WARNING: Always disconnect the electrical connector between the towing vehicle and the caravan before connecting a LV supply to the caravan.

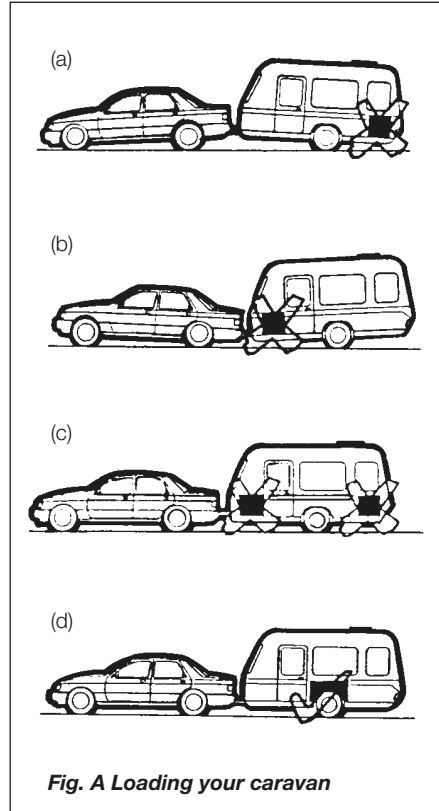

Fig. A Loading your caravan

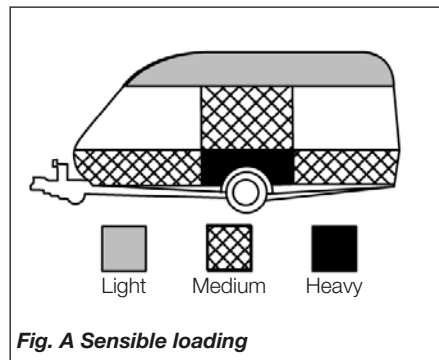

Fig. A Sensible loading

How to apportion it

1. Load heavy items low down near the floor and mainly over or just in front of the axle(s) (Fig. A).
2. Load evenly right to left so that each caravan wheel carries approximately the same weight.
3. Do not load items at the extreme front or rear since this can lead to instability due to the 'pendulum effect'.
4. Load remainder to give a suitable nose weight at the towing coupling.

Check nose weight.

Note: Do not overload car boot.

⚠ WARNING: All heavy and/or voluminous items (e.g. TV, radio etc) must be stored securely before travelling.

⚠ WARNING: Please take care to ensure that you have allowed for the masses of all items you intend to carry in the caravan. e.g. optional equipment, and personal effects such as clothing, food, pets, bicycles, sailboards, sports equipment etc.

⚠ WARNING: under no circumstances should the MTPLM of this caravan be exceeded

Towing vehicle's rear suspension

It is important that the towing vehicle's rear suspension is not deflected excessively by the nose weight on the tow ball. If it is excessive the steering and stability will be affected. (Fig. B)

The greater the towing vehicle's tail overhang (the distance between the rear axle and the tow ball), the greater the effect the nose weight will have on the towing vehicle's rear suspension.

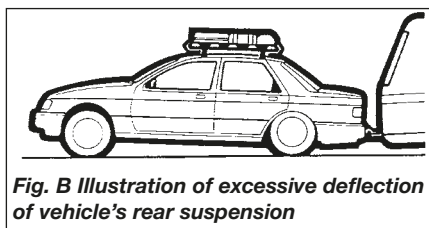

Fig. B Illustration of excessive deflection of vehicle's rear suspension

After trying out the caravan it may be found that a stiffening of the rear suspension is necessary - but note that this may give the towing vehicle a firmer ride when not towing.

There are a number of suspension aids available and advice should be sought on which to use and how to fit. It is important to ensure that the caravan is towed either level or slightly nose down.

If you have any doubts about the suitability of your towbar for towing a caravan consult the towing bracket manufacturer.

Do not exceed the:

- Gross Vehicle Mass (G.V.M. on car plate).
- Maximum Technically Permissible Laden Mass (M.T.P.L.M.) on the caravan.
- Gross Vehicle Combination Mass (Train Weight) (G.V.C.M. on car plate).
- Maximum Permissible Towing Mass.
- Vertical Static Load on the caravan coupling (noseweight).
- Maximum Vertical Load on the car towball as specified by towing vehicle manufacturer (noseweight).
- Driving licence limitations

STABILITY

Stability

All our models are of a well balanced design and should be exceptionally good towers. All models apart from the Sprite Freedom (AL-KO hitch), and the Sprite range (Diamond pack option) have an AL-KO stabiliser fitted as standard. The common causes of poor stability include:

- a. Worn springs or loose spring fixings on the towing vehicle.
- b. Towing vehicle springs too soft.
- c. Insufficient nose weight.
- d. Nose of caravan is towing too high or too low.
- e. Unsuitable towing vehicle

Galvanised steel chassis

Drilling of the galvanised steel chassis will invalidate the warranty and must not be done.

Towball

The AL-KO AKS 3004 stabiliser is designed to be used with a swan neck, fixed or detachable towball. If you use a 'bolt on type' towball you may need to replace your towball with a special extended neck towball.

If you have a bolt on type towball you should ask your dealer to check clearance around the towball to allow for the stabiliser to articulate.

The AL-KO extended neck towball (available from your dealer) is approved to 94/20/EC or UN ECE R55. Failure to provide enough clearance around the towball may invalidate your stabiliser warranty.

Stabiliser friction pads

The AL-KO AKS 3004 stabiliser uses 'friction pads' inside the coupling head to clamp the towball. These pads must be kept free from grease and contamination from the towball.

The friction pads should last approximately 50,000km (30,000 miles) under normal use, if correctly maintained.

Suitable towing vehicles

The caravan is manufactured for towing behind normal road cars and is not suitable for towing behind commercial vehicles. It is strongly recommended that whenever a

caravan is to be towed over rough terrain, e.g. a field or track, great care should be taken to ensure that no undue stress is placed upon the caravan via the hitch mounting, i.e. reduce speed. If in doubt, please consult the chassis manufacturer and the towing vehicle manufacturer who will advise. Touring caravans based on standard AL-KO chassis can be towed by four wheel drive off road leisure vehicles providing the unit is used to tow in a like manner to a conventional road-going car and driven in the same considered manner.

Towbar manufacturers should be consulted before towing an uncompensated twin axle caravan.

Snaking

This is a term used to denote an unstable car and caravan combination where the caravan 'weaves' from side to side often causing a similar swaying movement in the car itself.

Causes:

1. Unsuitable or unbalanced outfit.
2. Incorrect loading or weight distribution.
3. Excessive speed especially downhill.
4. Side winds.
5. Overtaking.
6. Being overtaken by a large fast moving vehicle.
7. Erratic driving.
8. Incorrect tyre pressures, car and caravan
9. Incorrect vehicle towball height
10. Worn stabiliser pads or towball

Cures

Cases of persistent snaking can be alleviated by the use of a stabiliser.

On the road

If you do find your outfit snaking, try to keep the steering wheel in a central position as far as possible, decelerate and avoid braking if possible.

Types of tyres fitted

The original tyres fitted by the manufacturer are suitable for towing at maximum speed of up to 81 mph (130 kph).

Tyres

Caravan manufacturers choose the type, size, profile, load carrying capacities and speed ratings to match the design masses of these vehicles, adjusting the tyre pressures to suit. Only change the type of tyres on your caravan on expert advice from the caravan manufacturer, or tyre manufacturer.

Tyre maintenance

Tread depth

Pay special attention to the amount of tread remaining on your tyres, and measure them regularly. Always replace tyres before they reach the minimum legal limit of 1.6mm. Periodically tyres should be rotated to equalise wear in the same manner as car tyres.

Pressures

The caravan manufacturers plate (fixed adjacent to exterior door) and Technical handbook contains information about caravan loading and the required adjustments to tyre pressures, which should be followed for safety (these pressures relate only to the tyres originally fitted to the caravan). Tyre pressures should always be checked and corrected prior to each journey. It is vital that tyre pressures are maintained at the levels recommended by the manufacturer to ensure maximum tyre life, safety and handling characteristics.

Over or under-inflating tyres is likely to seriously impair their performance and may prejudice the safe use of the vehicle.

Over-inflation increases overall tyre diameter, decreases the amount of tread in contact with the road, decreases sidewall flexibility and affects road-adhesion.

Under-inflation decreases overall tyre diameter, increases sidewall flexing, generates higher tyre operating temperatures and difficult vehicle handling characteristics. Running an under-inflated tyre may cause premature tyre failure. Both over and under-inflation adversely affect tyre life.

Treads

Keep tyre treads clean of stones and other foreign bodies, and check regularly for damage to the tread and sidewalls. It is vitally

important that any damage is checked out by a tyre expert and any necessary repairs or replacements are carried out immediately.

Tyre valves

Check tyre valves carefully. Ensure the caps are in place free from dirt/ debris and that there is no evidence of cracking or damage to the valve stem.

Tyre aging

Rubber compounds used in tyres contain chemicals that help to slow down the natural aging process of untreated rubber. However, tyres do deteriorate with age, which increases the risk of tyre failure, and there are many ways in which this can be spotted:

- Cracking/crazing on the side wall of the tyre, caused by its flexing
- Distortion of tyre tread
- Deformation of the carcass of the tyre

There will also be a deterioration of the ride quality caused by vibrations through the tyre. This may signify the tyres performance has been affected by age and should be investigated as soon as possible

Note: It is recommended that tyres are replaced after 5 years from the date of first inflation. The date of first inflation is normally within a few days of the date of manufacture of the vehicle they are fitted to, and this date can be determined from the gas and / or electrical certificate supplied with the caravan.

We recommend that tyres that are over 5 years old (from first inflation) are inspected and passed as fit for use by a qualified technician. It is possible that in the event of a tyre failure, an insurer may not cover any losses incurred if the tyre is over 5 years (from first inflation) and was not inspected no more than 12 months prior to the incident.

Tyres that display signs of aging should be removed and not put to further use.

The effects of aging can be brought about prematurely in several conditions. Tyres fitted as spare wheels may age prematurely. If

TYRE LAW / HITCHING UP

tyres on caravans are not in regular use they should be inspected before every journey, several cleaning products may also harm the chemicals in the rubber. However, the age of a tyre will affect its safety and increase the risk of failure, and you should inspect tyres for the signs of aging regularly.

Note: The use of some motor movers can damage or increase wear on the tyres prematurely.

The tyre law

Note: Sales literature/ Technical Handbooks publish recommended tyre pressures for the MTPLM only (fully laden condition). It is not possible to publish tyre pressures for any other load condition other than the MTPLM.

Tyre types

It is illegal to mix tyres of a different construction on the same axle.

Note: Although the caravan may be fitted with the same type of tyre as the towing vehicle, the pressures specified are different. All charts show values for cars and are therefore not applicable for caravans.

Pressures displayed on tyre walls apply ONLY in North America and Canada.

Wheels

Caravan wheel bolts supplied with your caravan should be tightened to a torque of 88Nm (65lb/ft) on steel wheels or 130Nm (96lb/ft) on alloy wheels and should be checked with the use of a torque wrench regularly. Only use a spare wheel and tyre of the type and size provided with your caravan.

Note: Please remember to check the wheel bolt torque setting regularly.

Wheel rims

Two sizes of wheel rims are used 5.5J x 14 and 6J x 15, the rim sizes are the same for both steel and alloy rim, incorporating a double

safety hump which conforms to European safety standards. Check the size on your caravan before replacing a rim.

Hitch head load capacity

The maximum vertical static load which can be put upon the hitch head when connected is 100kg. Please refer to the technical data in your handbook. (But see also vehicle manufacturer's weight limits on towball loading.)

Hitching-Up

An assistant can help in the hitching operation by standing on the left hand side of the drawbar (facing rear of car) and extending an arm horizontally to indicate position of the coupling. When reversing aim the towball of the car directly at the caravan drawbar. Remove towball cover and keep in car.

Adjust the jockey wheel to ensure the hitch head is high enough to slide over the towball.

AK160 Type Hitch head

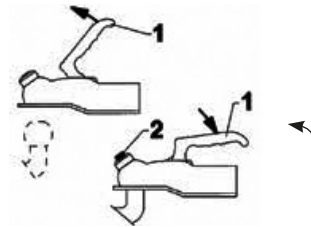

Fig. A

Open the locking mechanism by pulling the coupling handle upward in the direction of the arrow (Fig.A item 1). The handle will remain in the open position until the hitch head is positioned onto the towball.

Release the caravan handbrake and manoeuvre the hitch head over the **greased towball** and re-apply the handbrake. Using the jockey wheel winding handle, lower the hitch head carefully onto the towball. The pressure of the towball within the hitch head will release the locking tongue with an audible click and the coupling handle should drop down. For safety check that the coupling handle is fully down by pushing the handle down manually. When the hitch head is

correctly coupled to the tow ball the green collar of the locking display button will be visible. (Fig A item 2). If the green collar is not visible it is not safe to tow the caravan. Contact your dealer for advice.

AKS 3004 Hitchhead



Fig. A

Release the caravan handbrake and manoeuvre the hitch head over the **ungreased towball** and re-apply the handbrake. Lift forward the large stabiliser handle (Fig. A) lift forward the exposed smaller handle (Fig. A) until it clicks up.



Fig. B

The hitch head is fitted with a visual indicator to show whether or not it is properly connected to the towball. A green band will show immediately below the red indicator button on the hitch head when a proper connection has been made. (See Fig. B)

If the green band is not visible it is not safe to tow the caravan. Contact your dealer for advice.

Adjust jockey wheel to lower the hitch head onto the ball. A click indicates it is fully engaged. Ensure the smaller handle has returned to its free position.

Firmly push down the large stabiliser handle to engage the friction pads. (Fig C)



Fig. C Stabiliser Handle

Connect breakaway cable as described on page 29.

Ensure that the jockey wheel is fully wound up and properly located in the slots in the jockey wheel tube, then release the clamp handle, lift the whole unit as high as possible ensuring the wheel is pointing directly backwards and retighten the clamp handle.

Note: Ensure jockey wheel locates in the recess provided. Carelessness could result in damage to the A-frame cover.

Note: Ensure the hitch is secure by checking the visual indicator (figure B).

⚠ WARNING: If the green band is showing when the hitch head is not connected to the towball there is a fault- contact your Dealer.

Connect the 13 pin plug to car socket by inserting and rotating slightly ensuring there is enough loose cable for cornering, ensuring they won't drag on the ground. (See page 28 for further details)

HITCHING UP

Pre-Tow Check List

Check gas locker, battery locker and cassette toilet doors are secure.

Check wheelnuts, tyre pressures and tyre conditions.

Fully raise all four corner steadies. (Fig. D).



Fig. D

Pick up any levelling pads or levelling boards.

Check windows/rooflights/vents are securely closed.

Ensure television aerial is lowered (where applicable).

Switch off gas supply and change over to 12v electricity if required.

Lock the caravan exterior door.

Check all car and caravan roadlights are working.

Check round the caravan for anything left behind.

Fit extending mirrors

Release caravan handbrake, adjust all mirrors from driving seat and proceed.

- All road lights must be in working order.
- Lenses and reflectors must be in good condition
- Bulbs must be of correct wattage for the application (see Service handbook).

⚠ WARNING: Do not cause any road lighting to be obstructed by the addition of any options or accessories to your caravan.

13 Pin socket

Please be aware that some car manufacturers and towbar manufacturers do not wire up all 13 pins as standard, unless requested.

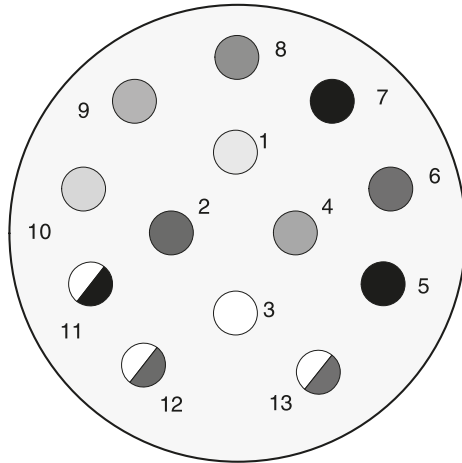

11446 Plug Connector viewed
from cable entry on plug

Pin No	Core Colour	Core Size	Function
1	Yellow	1.5	Left Hand Indicator Light
2	Blue	1.5	Rear Fog Warning Light(s)
3	White	2.5	Earth for pins 1 - 8
4	Green	1.5	Right Hand Indicator Light
5	Brown	1.5	Right Hand Tail Light
6	Red	1.5	Brake Lights
7	Black	1.5	Left Hand Tail Light
8	Pink	1.5	Reverse Light(s)
9	Orange	2.5	Car +ve
10	Slate (Grey)	2.5	Fridge +ve
11	White/Black	2.5	Earth for pin 10
12	White/Blue	1.5	Not Yet Allocated
13	White/Red	2.5	Earth for pin 9

TOW CAR ELECTRICS

Tow Car Electrics

In all cases, The Swift Group assumes that the tow car harness and electrics have been fitted with the specific requirement of connection to a caravan, which may contain AL-KO trailer control (ATC), a 12V powered fridge and charging circuits.

Most modern retro-fit towbars contain a relay, located somewhere within the boot of the tow car, which may have a selectable power output for the fridge supplier.

If a customer is experiencing issues with the fridge supply it is possible the relay requires adjustment and they should contact their tow vehicle electrics installer or an auto electrician to verify the installation.

Road Lighting

Your caravan is fitted with LED road lighting, including the directional indicators and stop lamps. LEDs consume very little power, offer excellent light output and longevity when compared to traditional tungsten bulbs.

Some more advanced tow cars are fitted with Vehicle Light Monitoring Systems (VLM), where the car monitors the condition of the trailer/caravan road lights and advises the driver of any bulb failures. To do this, some tow cars expect to see a load on the caravan lighting circuit similar to a tungsten bulb while others may send a pulse of energy to each light to confirm that the resistance of a bulb is present.

The result of the above is that some tow cars may incorrectly advise the driver of a bulb failure, due to the use of LED lights while others may flash or pulse the lights during use.

Recognising this, The Swift Group have developed an additional towing fusebox, which when connected to the existing towing fusebox and is used to assist the towcar in recognising the VLM System. Depending on the type of car and system used the fusebox maybe model specific.

The secondary fusebox is chargeable and available through any Swift Group Dealer.

Caravan 13 Pin Connection - care advice

All caravans since 2008 have been supplied with a 13 pin plug to connect to the towcar. The 13 pin plug has an inner ring assembly that is independent from the outer body.

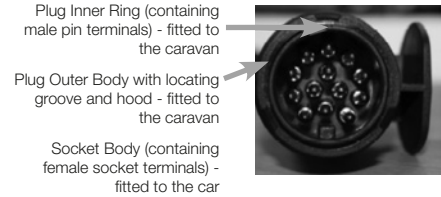

Under normal circumstances the inner ring and the outer body will be locked in one position (see fig 1).

**Fig. 1**

When the plug is first inserted in the socket body ensure that the locating protrusion (key) matches the groove (keyway) in the socket body. The outer body can then be rotated a full 90 degrees clockwise until a click is felt or heard, at this point the cover flap can be allowed to fall over the circular surface of the plug top.

To remove the plug it is important to rotate the outer body a full 90 degrees anti-clockwise, again until a click is heard or felt before withdrawing the plug from the socket. This will ensure that the inner and outer parts of the plug are returned to a locked condition.

WARNING: If the connector is not fully rotated anti-clockwise prior to removing it from the socket it is possible that the inner ring will become 'floating' and may result in a condition where the protrusion will be incorrectly aligned (see fig 2 & 3).



Fig. 2



Fig. 3

If this situation does occur then it can be corrected by inserting the edge of the protrusion on the plug into the groove in the socket (see Fig 4) and rotating the plug body anti-clockwise until a click is felt. This process will re-establish the lock between the inner and outer parts allowing the correct insertion of the plug into the socket.



Fig. 4

Note: Customers should note that the towbar and towcar electrical socket will be checked from the 1st January 2012 as part of the standard MOT regulations, under directive 2009/40/EC. This not only applies to tow cars but also all Motorhomes fitted with a tow bar and socket. Inappropriate repair or modification to either maybe deemed a failure of the vehicle if it is likely to affect the road worthiness of the vehicle.

Passengers

Passengers are forbidden to ride in a caravan.

Breakaway cables

UK law requires that all caravans are fitted with a safety device to provide protection in the unlikely event of separation of the main coupling while in motion. A device referred to as a 'breakaway cable' fulfils this requirement and when fitted as on your caravan is mandatory.

Purpose

To apply the caravans brakes if it becomes separated from its towing vehicle. Having done this, the cable assembly is designed to part allowing the caravan to come to a halt away from the towing vehicle.

Construction

A thin steel cable with a red plastic coating fitted with a means of attachment for connection to the towing vehicle. Located directly beneath the coupling head.

Operation

In the event of the main coupling of the caravan separating from the towing vehicle, the cable should be able to pull tight, without any hindrance, engaging the caravan brakes. The breakaway cable should not become taut during normal driving.

Correct procedure for use

Regularly check the cable and clip for damage. If in doubt contact your Swift Group dealer.

Make sure the cable runs as straight as possible and goes through the cable guide fitted underneath the caravan coupling head.

Determine whether or not the towing vehicle towbar has a designated attachment point (i.e. a part specifically designated for a breakaway cable).

Where a point is designated on the towbar:

- Either pass the cable through the attachment point and clip it back on itself (Fig 1) or attach it directly to the designated point (Fig 2).

MIRRORS

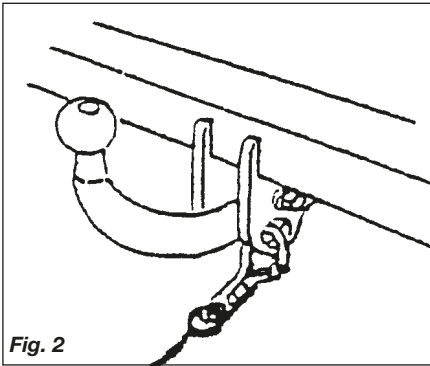
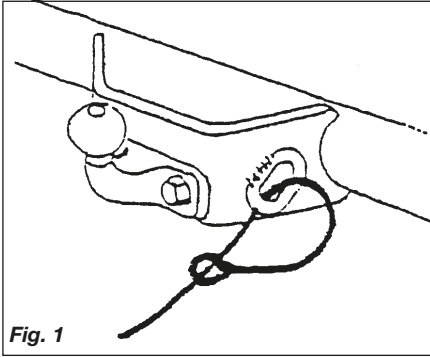

Where there is no designated attachment point on the towbar:

- Fixed ball: Loop the cable around the neck of the towball in a single loop only. See figure 3A and 3B.

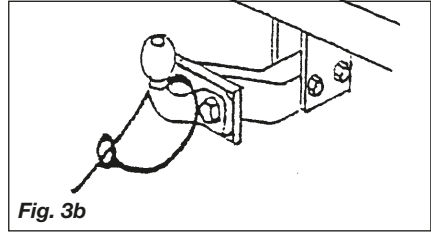
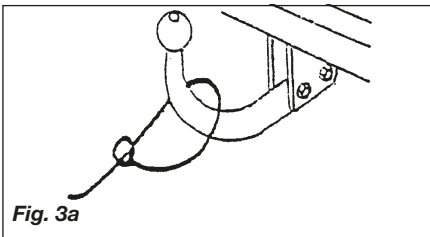

In some instances it may be possible to attach the cable assembly either to a permanent part of the towbar structure, as long as this meets the approval of the towbar manufacturer/supplier, or to an accessory sold for the specific purpose of breakaway cable attachment. For vehicles fitted with detachable towbars, guidance must be sought from the towbar manufacture/supplier on the correct method for attaching the breakaway cable.

When the breakaway cable is attached it must not snag in use on the trailer coupling head, jockey heel or any accessories, e.g. a stabiliser, bumper shield, cycle carrier, etc. There should also be sufficient slack in the cable to allow the towing vehicle and trailer to articulate fully without applying tension to the cable which could otherwise cause the trailer brakes to be inadvertently applied.

The cable must not be allowed to drag on the ground. If there is too much slack, the cable might drag on the ground and be weakened so that it has insufficient strength to apply the brakes in the event of the trailer becoming detached when in motion. Excess slack may also lead to the cable being caught on an obstacle when in motion, leading to inadvertent application of the trailer brakes.

Care must be also taken to ensure that the cable cannot be entangled with the electrical cables.

Mirrors

The driver of the towing vehicle must have an adequate view of the rear.

If there is no rear view through the caravan it is essential that additional exterior towing mirrors are fitted. This is mandatory in some European countries and drivers can face instant fines if extension mirrors are not fitted.

⚠ WARNING: Any rear view mirror must not project more than 250 mm outside:

- the width of the caravan when being towed.
- the width of the towing vehicle when driven solo.

Note: Any rear view mirror fitted shall be 'e' marked and cover the field of view as stipulated by type approval requirements (Community Directive 2003/97 or 2005/27 or ECE Regulation 46.02 or Regulation 33 of the Road Vehicles (Construction & Use Regulation 1986).

Moving off

Let the clutch in smoothly.

Allow more engine speed to produce the power to move the additional weight of the caravan.

Reduce wear and tear on clutch and transmission by taking extra care.

Change gears smoothly.

Try not to jerk the clutch.

Reversing

When the towing vehicle is reversing, the overrun device shaft is pushing in, applying the brakes via the overrun lever, brake rod system, bowden cables and the expander mechanism.

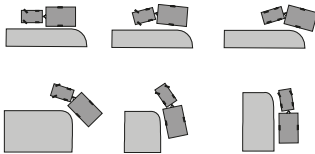

Fig. A Reversing

The backwards rotation of the brake drum causes the secondary brake shoe to collapse cancelling out the braking effect, allowing the caravan to move backwards. At the same time the transmission lever swings back and compensates for the entire travel.

When reversing up a slope or on a loose surface the brakes may apply themselves. Correct maintenance and set up of the brakes

will help prevent this. Incorrect adjustment of the wheel brakes or linkages will result in making reversing difficult.

Proficiency at reversing can only be achieved with practice and should be first attempted in a large open area (Fig. A).

Speed limits

Single carriageway: 50mph

Motorways (including dual carriageways): 60mph

Caravan handling

Allow for caravan being wider than car.

Do not bump kerb with caravan wheels.

When passing other vehicles allow more than the normal clearance for driving solo.

Allow longer to build up speed to pass.

Allow for the outfit being twice its normal length.

Do not suddenly swing out.

Carry out all manoeuvres as smoothly as possible.

Use nearside wing mirror to check caravan has cleared when overtaking.

⚠ WARNING: Take care not to foul or ground caravan chassis whilst traversing ramps or other obstacles.

Motorway driving

Important points

- Caravans may not be towed in the out-side lane of a three or four lane motorway. (Reg. 12(2) of the Motorway Traffic [England and Wales] Regulations 1982).
- Reduce Speed:
 - In high or cross winds
 - Downhill
 - In poor visibility
- High sided vehicles cause air buffeting so extra care must be taken when passing or being passed. As much space as possible should be given.

CHANGING A WHEEL

AL-KO Spare wheel carrier tips

The spare wheel will either be mounted on a boss (under beds or in the gas locker), or on the AL-KO carrier under the rear of the van.

The caravan needs to be jacked to the maximum lifting height to be able to withdraw the wheel from the carrier.

Note: The side-lift jack when fitted, has a maximum lifting height of 375mm and the scissor jack a maximum lifting height of 340mm.

Customers should also ensure that the telescopic arms are kept well greased at all times to guarantee ease of operation.

⚠ WARNING: If it becomes necessary to completely remove the carrier from the chassis remember that the washers and split pins are on the inside of the chassis as well as the outside.

Note: On some models the spare wheel is located in either the gas locker or under the fixed bed.

Changing a wheel

1. Leave caravan hitched to towing vehicle and ensure that the caravan and towing vehicle handbrakes are applied.
2. Lower corner steadies (as safety measure) on the side that is being jacked up.
3. Remove wheel trims (if fitted).
4. Use wheel brace to slacken off wheel nuts on the wheel to be changed.
5. Position jack under the axle at the appropriate jacking point (see Fig. B, page 33)
6. Jack up the caravan until the wheel for removal is just off the ground.
7. Remove the wheel nuts and remove the wheel.
8. Fit spare wheel and reverse the above procedure. Ensure clean, dry mating surfaces and clean, dry bolt/nut sealing areas.

9. Ensure the spare wheel is free from damage and distortion
10. Tighten all five bolts, according to Fig. A, to 88Nm (65lb/ft) for steel wheels or 130Nm (96lb/ft) for alloy wheels using a torque wrench or have checked as soon as possible. Ensure the correct wheel fixings are used, as supplied with your caravan.

⚠ WARNING: When a wheel has been removed and replaced the torque of the wheel nuts should be re-checked after approximately 50 miles.

Wheel bolt tightening

When refitting a wheel it is ESSENTIAL that the wheel bolts are tightened to the recommended torque figure and in the correct sequence.

Note: Only use a suitable wheel brace to loosen and tighten the wheel bolts. Do not use the corner steady brace for this application.

The sequences necessary to correctly carry out this work on a 5 stud wheel is as follows:

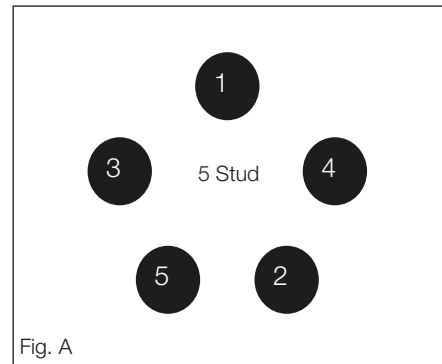

Fig. A

Please note the correct torque settings.

Jacking points

⚠ WARNING: Only jack up your caravan when it is coupled up to the car with its handbrake applied and in 1st gear (engine off).

Ensure that the jack is located in the correct position, i.e. on the jacking bracket on the chassis for the AL-KO side mounted jack (Fig.B). Alternatively the reinforced axle mounting plate can be used but the chassis member itself **MUST NEVER** be used as a jacking point.

All caravans are provided with the facility to fit AL-KO side jacking points although a scissor, trolley or bottle jack may be used.

Ensure the lifting capacity of your jack is suitable for your caravan.



Fig. B Side lift jack

Stopping on a hill

Pulling off again can sometimes present a problem. The easy solution is

1. Carry a good sized wedge shaped piece of wood with a rope or light chain attached.
2. Attach the other end of the rope to the nearside rear grab handle.
3. Place the wood behind the nearside caravan wheel.
4. Carefully reverse the car slightly back down the hill, the caravan will stop against the wedge and turn.

5. Drive forward since this attempt to move up the hill will now not involve pulling the full weight of the caravan until the car has gained some traction.
6. When reaching the top of the hill retrieve the wedge.

Arrival on site

Note: Check and observe site regulations.

Manoeuvring your caravan by hand

Note: Care must be taken when manoeuvring your caravan into position. Pressure placed on unsupported parts of front and rear GRP panels may cause surface damage/ cracks to appear. Use the grab handles provided.

1. Selecting a pitch

Do not pitch in such a position that your outfit will obstruct others coming in.

Try to choose an area which is dry, reasonably level and preferably with a hard base.

If you have no alternative but to pitch on a slope ensure that, for when you leave, you are facing down the slope.

It is good practice to chock the wheels of the caravan when parked on a slope even though the caravan brakes are applied.

2. Levelling the caravan

Levelling must be carried out in both directions in order for the refrigerator and other equipment to function correctly. This should be done before unhitching the caravan. Levelling boards (Fig. C) can be used to raise one side of the caravan by driving or reversing the caravan onto the boards. Apply the handbrake and chock the wheels.

The positioning of the jockey wheel can be used to help level the caravan.

Lower the corner steadies until they are in firm contact with the ground.

In some cases, depending on the ground condition, additional feet maybe required to elongate the steadies.

AKS 3004 STABILISER / EXTERIOR DOOR

⚠ WARNING: DO NOT use the steadies as a jack they are only a means of stabilising the caravan.

Levelling pads or boards should be used under the steadies where the ground is soft or uneven.

In extreme cases where it is necessary to raise a wheel off the ground for levelling purposes, further adequate support should be applied so that the steadies do not take any undue strain.



Fig. C Levelling board

Unhitching

Before applying the handbrake ensure the hitch is fully extended and not compressed behind the tow vehicle otherwise the hitch will not release from the tow ball.

Apply the caravan handbrake.

Lower the jockey wheel to the ground.

Disconnect the breakaway cable and road lighting plugs.

AKS 3004

Release the stabiliser by lifting the large handle. Then lift the exposed small handle forward until it clicks up, at the same time winding down the jockey wheel, to lift the caravan clear of the tow ball.

Exterior door

To prevent distortion of the body, the caravan must always be correctly sited and levelled. Failure to site the caravan correctly may prevent the exterior door from closing properly.

Fire	36
SI 601 Smoke alarm operation	36
Alarm test	37
Fire extinguisher	38
Escape paths	38
Children	39
CO Alarm - Fireangel CO-9D carbon monoxide alarm operation	39
CO Alarm - what to do during an alarm	39
CO Alarm maintenance	44
Ventilation	46
Security	47
Swift Command tracker.....	47
AL-KO secure immobiliser	48
Mobile alarm system	49
PIR internal sensor	50

FIRE AND FIRE ALARM

Fire

Important: Your attention is drawn to the notice affixed inside the caravan wardrobe advising on fire precaution, ventilation and what to do in case of fire.

In case of fire

1. Get everyone out of the caravan as quickly as possible using whichever exit is the quickest, including windows. Do not stop to collect any personal items.
2. Raise the Alarm. Call the Fire Brigade.
3. Turn off the gas supply valve if it is safe to do so.
4. Turn off the electricity supply at supply point.

Model-si 601 smoke alarm operation

Normal condition

The red LED on the front should flash once every 40 seconds to show the alarm is active.

Low Battery Condition

Important: Your smoke alarm requires a battery with a sufficient capacity of power to operate correctly. This must also be correctly installed.

Should your smoke alarm enter a low battery condition, the unit will emit an audible 'chirp' once every 40 seconds. When this occurs you must replace the battery immediately. Your smoke alarm will continue to warn of this low battery condition for at least 7 days, however, failure to change the battery after this time would mean your smoke alarm has insufficient power to alert you in a real fire situation.

Battery replacement

Important: Only the following batteries can be used for replacement. Use of a battery other than those recommended below may have a detrimental effect on the detector's operation. Use of a lithium (long-life) battery could provide power for 10 years under normal operating conditions, meaning there is no need for an annual battery change.

Note: The alarm cover can't be installed without a battery fitted.

Note: Upon delivery the battery may be fitted with a protective cover. Please ensure this is removed before use.

Carbon-Zinc type:

Eveready Energizer 1222;
Gold Peak 16045 (UL).

Alkaline Type:

Energizer 522; Duracell MN 1604; Duracell 9V Ultra; Energizer 9V Ultra+; Gold Peak 1604A.

Lithium (long life) type:

Ultralife U9VL

1. Remove the alarm from its mounting plate by turning anti-clockwise



2. Remove the existing battery and replace with a new battery from the list above, making sure that the positive and negative connections are in the correct position. If unsure see the alarm user manual.



3. Replace the alarm on its mounting plate, lining up the large central vent on the front of the alarm, with the 'X' that is moulded into the plastic on the mounting plate (if unsure see page 13 of the alarm user manual). Ensure the unit is securely fitted.



4. Test your alarm as explained in the next section 'Alarm Test'.

Alarm test

1. Press the test button in the centre and release.



2. The unit will emit a loud (85dB at 3 meters) alarm for around 5 seconds and stop automatically.



3. The red LED on your alarm will flash rapidly during the audible signal.



FIRE ALARM

Note: The test button accurately tests the alarm's smoke sensing circuit, there is no need to test your alarm with smoke. If your smoke alarm fails to give an audible test signal, please refer immediately to the troubleshooting guide at the end of the alarm user manual.

⚠ WARNING: Test your smoke alarm at least once per week.

Your smoke alarm has been designed to be as maintenance - free as possible and although the unit requires only battery maintenance for its entire life, there are several things you must do to keep it working properly.

⚠ WARNING: Your smoke alarm is a sealed electrical device and no attempt should be made to open the case. Attempting to open the case will invalidate your Warranty.

Testing: Test your smoke alarm once every week, see page 37 on how to do this.

Cleaning: As a minimum your smoke alarm should be cleaned once every 3 months using your vacuum cleaner fitted with the soft brush attachment.



⚠ WARNING: Your smoke alarm may false alarm when it is being cleaned using a vacuum cleaner.

⚠ WARNING: Do not use solvents or cleaners on your smoke alarm, as they may cause damage to the sensor or circuitry. The unit can be wiped with a slightly damp cloth

⚠ WARNING: The electronic test button provides a full test of the unit's functionality. DO NOT try to test the alarm with a naked flame, as this may present a potential fire hazard.

⚠ WARNING: Never use portable cooking or heating equipment other than electric heaters that are not of the direct radiant type, as it is a fire and asphyxiation hazard.

⚠ WARNING: Appliances such as cookers must not be used for heating.

Fire Extinguisher

It is recommended that a dry powder fire extinguisher be carried inside your caravan at all times.

When using a dry powder extinguisher it is suggested that the caravan be evacuated until the powder has settled, to avoid inhalation.

A fat pan fire should not have a fire extinguisher aimed at it. It should be smothered with a fire blanket.

⚠ WARNING: Provide one dry powder fire extinguisher of an approved type or complying with EN 3-7, of at least 1kg capacity, by the main exterior door and a fire blanket next to the cooker. Familiarise yourself with the instructions on your fire extinguisher and the local fire precaution arrangements.

Escape paths

It is important that you do not block escape paths to emergency exits with obstructions or hazards.

Children

Do not leave children alone in the caravan in any event. Keep potentially dangerous items out of reach, as at home e.g. matches, medicine etc.

CO alarm

Fireangel CO-9D Carbon Monoxide Alarm

⚠ WARNING: Please read the full user instructions provided.

Carbon monoxide

Known as the silent killer, Carbon Monoxide is an invisible, odourless and tasteless gas.

What are the symptoms of carbon monoxide poisoning?

Early symptoms of carbon monoxide (CO) poisoning can mimic many common ailments and may easily be confused with flu or simple tiredness. Symptoms to look out for include:

- tiredness
- drowsiness
- headaches
- giddiness
- nausea
- vomiting
- pains in the chest
- breathlessness
- stomach pains
- erratic behaviour
- visual problems

Anyone with these symptoms should immediately turn off all appliances and seek medical attention.

What to do during an alarm

- Keep calm and open the doors and windows to ventilate the caravan.
- Stop using all fuel burning appliances and ensure, if possible, that they are turned off.
- Evacuate the caravan leaving the doors and windows open.
- Do not re-enter the caravan until the alarm has stopped. When exposed to fresh air it can take up to 10 minutes for the sensor to clear and the alarm to stop depending on the level of carbon monoxide detected.
- Get medical help immediately for anyone suffering the effects of carbon monoxide poisoning (headache, nausea), and advise that carbon monoxide poisoning is suspected.
- Do not use the appliance again until it has been checked by an expert. In the case of gas appliances the engineer must be Gas Safe registered.

⚠ WARNING: A loud alarm is a warning that unusually high and potentially lethal levels of carbon monoxide are present. Never ignore this alarm, further exposure can be fatal. Immediately check residents for symptoms of carbon monoxide poisoning, and contact the proper authorities to resolve all CO problems.

NEVER IGNORE ANY ALARM.

Please carefully review this owner's manual to ensure that you know what actions to take in the event of an alarm.



Note: If the level of CO in the sensor doesn't reach 50ppm then the Sensor Test mode will time out and finish automatically after 3 minutes. Even if the level doesn't reach 50ppm, as long as the display shows a reading of CO then you can be confident that the alarm is working correctly. If you have any questions about testing the sensor please contact the technical support team.

CO ALARM

Power Pack Activation

See diagram below

Your detector comes complete with an integrated power pack that will provide power for its entire operational life. To activate the power pack you need to pull the disabling tab (see image). This will in turn pull out the metal disabling clip, which is attached to the end of the tab, from the disabling socket located on the underside of the detector. Retain the disabling tab for future use by taping it to page 22 of the CO-9D user manual.

When the detector is activated the screen will display all of the icons, then after a few seconds will show the current CO level. The power indicator LED below the  symbol will also flash green once every minute to indicate that the detector is receiving power from the power pack and is fully operational. A  symbol will also flash briefly on the LCD screen approximately once every minute.

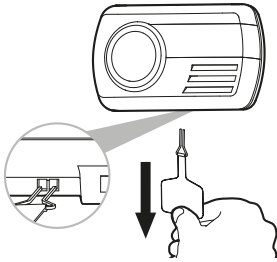

Test the sounder, power pack and circuitry by pushing the centre of the Test/Mode button briefly to confirm that the detector is operating properly. The sounder will sound as soon as the button is pressed, and the Alarm LED will illuminate red indicating that the sounder is working and the power pack is providing power to the unit. You'll notice that the display will switch to temperature mode, this is explained later in the manual, press button again to return to the CO display. This test for the sounder, power pack and circuitry should be performed on a weekly basis. This should be continued for the lifetime of the product.

⚠ WARNING: Prolonged exposure to the sounder in close proximity to your ears may damage your hearing.

Under normal operating conditions, the power pack will last for the lifetime of the product i.e 7 years. The detector will not protect against the risk of carbon monoxide poisoning when the power pack has drained.

⚠ WARNING: Prolonged exposure to extreme high or low temperatures may reduce the life of the power pack.

Power Pack Deactivation

Your CO-9D is portable making it ideal for taking with you on holiday. You will need to deactivate your detector when traveling or even when storing e.g when decorating. Fitting is reverse of removal. To deactivate the detector the two ends of the metal clip must be inserted into the corresponding holes in the disabling socket located on the underside of the detector (see image). You can ensure that the product is disabled by pressing the test button- If there is no sound from the sounder then the clip has been fitted correctly.

The clip must remain in the disabling socket to keep the power pack deactivated.

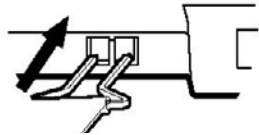

Note: If the disabling tab is no longer available then the clip can be replicated by opening out a thin metal paper clip into a U-shape.

Operating Features**Standby Mode**

The alarm can display two views when in normal standby mode, the current level of CO or the current room temperature in degrees centigrade (°C). When the alarm is showing the current CO Level you will see something similar to the following.

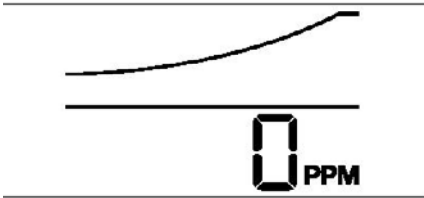

FireAngel's unique digital read out displays the amount of CO that the sensor is detecting shown in parts per million (PPM). It is designed to indicate levels from 10PPM to 999PPM.

Note: Ambient background levels between 0PPM and 10PPM will show as 0PPM

When the alarm is showing the current temperature you will see something similar to the following.



In both modes you will notice a  symbol appear briefly in the top left hand corner of the screen once every minute. This is an additional indication to show you that the alarm is operating as well as the flashing green LED.

To switch between CO and temperature view, simply press the Test/Mode button briefly. The unit will also sound when pressing the button to switch between the two display modes.

You will also notice that when switching between modes the display will change slightly, this is because the alarm is displaying the Peak Level CO reading that it has recorded in the last 4 weeks, please see the following peak level reading feature section for further description.

Note: If the alarm is in temperature view and detects CO it will automatically switch back to co display mode.

Power pack, sounder and circuitry test

Pressing the Test/Mode button will also test the power pack, sounder and circuitry of the alarm. The unit will sound and the alarm LED below  will illuminate red. You should perform this test once per week.

Peak Level Reading feature.

The alarm will record the highest reading of CO that it has detected in the last 4 weeks. This information is useful if your alarm has sounded so you can see the highest level of CO detected during that time. It is also useful to check periodically to see if a readable level of CO has been detected for a short time, but not long enough to trigger a full alarm. The peak level reading is shown briefly every time you press the Test/Mode button and will look something like the image below.



Note: It is possible and quite normal for the peak level to remain at 0ppm, i.e. this simply means that the alarm has not detected any CO in the last 4 weeks.

The Peak Level reading will be reset to 0ppm whenever a Sensor Test is carried out. (See the next section for Sensor Test).

Sensor Testing

⚠ CAUTION: Sensor testing should only be performed by a responsible adult. This test should only be performed once a month. Excessive testing will shorten the life of the power pack.

CO ALARM

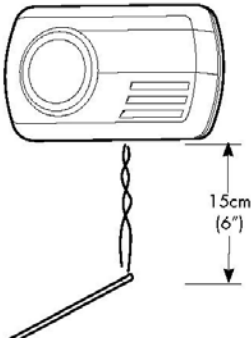

Note: We suggest the use of an incense stick or cigarette as the way in which these products burn produces a readable localized amount of CO. A readable level of carbon monoxide will not be given off by other sources of smoke, for example an extinguished candle or match.

Step 1: If the alarm is wall mounted unhook it from the fixing screws.

Step 2: Hold the Test/Mode button down until the spanner icon appears in the bottom left hand corner of the screen and the bar graph 'scans' from left to right. This indicates the alarm is in sensor test mode where the sampling rate of the sensor has increased and the alarm can be tested using a known source of CO.

Step 3: Light an incense stick or cigarette using a match or lighter. Extinguish the lighter, or put out the match and place it into a dish of water.

Step 4: Hold the incense stick or burning cigarette 15cm (6 inches) below the detector, so that the smoke goes into the holes at the bottom of the detector. As the smoke gets into the alarm the display will show the amount of CO being detected. When the level of CO in the sensor reaches 50ppm the alarm will sound a single alarm cycle, this confirms that the sensor is working correctly and is the end of the sensor test. The alarm will return to normal standby mode.

Step 5: Put out the incense stick or cigarette by placing it into a dish of water. Ensure that all flames have been extinguished.

Note: If the level of CO in the sensor doesn't reach 50ppm then the Sensor Test mode will time out and finish automatically after 3 minutes. Even if the level doesn't reach 50ppm, as long as the display shows a reading of CO then you can be confident that the alarm is working correctly. If you have any questions about testing the sensor please contact the technical support team

Understanding the Product's Indicators

Digital Display

The LCD screen has many icons with one or more being shown at any one time.

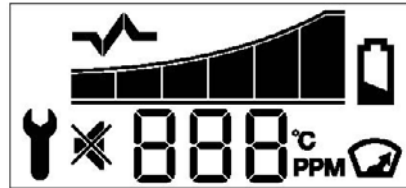

Bar Graph to show early build up of CO.

To understand the role of the product indicators please refer to section 'Carbon Monoxide and how it can affect your family' on page 3 of the CO-9D User Manual. The alarm has a bar graph which mimics the way CO levels build up in the blood stream. The response times of the alarm are determined by the European Standard BS EN 50291:2001 so the alarm will only sound when it has detected CO for a prescribed length of time, the higher the level of CO the quicker the alarm must sound. However with FireAngel's CO-9D there is an early visual warning that CO is present. When CO is first detected the alarm indicates it's presence by displaying the level on the screen in parts per million (ppm). If CO continues to be present additional bars will appear on the graph. When the graph is full

(i.e. the 6th segment is shown the unit will sound a loud audible alarm (85 dB at 1m (3 feet)) and the Alarm LED below the  symbol on the front of the detector will flash red once every second.



The Alarm will sound

- Between 60 and 90 minutes when exposed to a minimum of 50ppm of CO.
- Between 10 and 40 minutes when exposed to a minimum of 100ppm of CO.
- Within 3 minutes when exposed to a minimum of 300ppm of CO.

Alarm silence



It is possible to temporarily silence the alarm up to two times if the level of CO that triggered the alarm is less than 200ppm. After ventilating the caravan you can temporarily silence the alarm by pressing the Test/Mode button, the alarm will stop and the silence mode symbol will appear on the screen. The silence mode will last for up to 3 minutes. If the CO level remains too high the alarm will trigger again or if the level of CO rises above 200ppm then the detector will automatically re-enter alarm mode. If the level of CO has fallen to a satisfactory level the silence mode icon will disappear, the unit will exit alarm mode and the segments of the bar graph will slowly disappear as the CO in the sensor clears.

Alarm in absence:



If the Peak level reading symbol is showing on the screen but there is no full alarm sound and you are not pressing the test button, then your detector is warning that it has detected Carbon Monoxide in your absence. Immediately vacate the caravan and seek medical attention for anyone suffering the effects of CO poisoning (headache, nausea). Treat this as a serious warning. Call a qualified

technician and have the problem investigated and rectified immediately.

Error signal

 The unit continuously checks the settings of its sensor and circuitry. If any of these settings are found to be incorrect, the detector will emit a **single chirp** once per minute and the display will show "Err" for error and an error code, cycling between "Err" and the particular error code.

Low power pack signal



If the power pack becomes low then the detector will emit a single chirp once per minute and the low power pack icon will flash on the screen.

 **IMPORTANT:** A single chirp once per minute together with an error signal 14 or low power pack warning does NOT mean that the detector has detected carbon monoxide.

If you experience an error condition or low power pack warning and the product is still within warranty then contact technical support. If the product is no longer in warranty **replace immediately!**

CO ALARM

⚠ IMPORTANT: The selected power pack was chosen to provide power beyond the lifetime of the product, in particular the sensor (under normal operating conditions). The operational life of the sensor is seven years, for this reason, the detector should be replaced after seven years from the date of installation.

FireAngel Technical Support Line

9.00am – 5.00pm, Monday – Friday

**Telephone: 0800 141 2561
(1-800 523171 in EIRE)**e-mail: technicalsupport@fireangel.co.uk**Maintenance**

Your detector will alert you to potentially hazardous CO concentrations in your caravan when maintained properly. To maintain your FireAngel detector in proper working order, and to ensure that the sensor will last for the lifetime of the product, it is recommended that you:

- Test the sounder, power pack and circuitry of your detector at least once per week by pressing the Test/Reset button briefly (see above).
- Perform the Sensor Test once every month (See p41).
- Keep the detector free of dust by gently vacuuming the case with a soft brush attachment once per month.

To prevent the possibility of contaminating the sensor in your detector and thus affecting its reliability:

- Never use cleaning solutions on your detector. Simply wipe with a slightly damp cloth.
- Do not paint the detector.
- Do not spray aerosols on or near the detector.
- Do not use any solvent based products near the detector.
- Move the detector to a safe location and store in a plastic bag before painting, wall papering, or performing any other activities

using substances that emit strong fumes. Remember to remove it from the bag and replace the detector when these activities are finished.

Failure of any test should be reported to the FireAngel Technical Support Team. Do not attempt to repair your CO detector. Do not remove any screws or open the main casing of your detector. Any attempt to do so may cause malfunction and will invalidate the warranty.

Disposal

Waste electrical products should not be disposed of with regular household waste. Please recycle where facilities exist. Check with your local authority, retailer or manufacturer for recycling/disposal advice as regional variations apply. The power pack should be deactivated before disposal. To do this, insert the two ends of the metal clip on the end of the disabling tab back in to the socket located on the underside of the detector. If the disabling tab is no longer available then the clip can be replicated by opening out a thin metal paperclip into a U-shape. You can also return your carbon monoxide detector to Fireangel for disposal. For return address contact Fireangel Technical Support. Please include a note confirming the product is being returned for disposal.

Technical Information

Detector Specifications: Model CO-9D
 Sensor Type: Electrochemical
 Sensor Life: 7 Years
 Alarm Sound Level: 85dB at 1 metre (3 feet)
 Power Pack Life: 7 years (Life of product)
 Temperature Range: -10°C (14°F) to 40°C (104°F)
 Operating Humidity Range: 30 - 90% RH
 Weight: 120 grams (4.23oz)
 Certified to: BS EN 50291:2001

This FireAngel carbon monoxide detector is designed to continuously monitor for CO. Its response times meet the requirements of BSI standard BS EN 50291:2001.

⚠ WARNING: DO NOT ATTEMPT TO OPEN - DO NOT BURN



⚠ WARNING: APPARATUS CONFORMING TO THIS STANDARD MAY NOT PROTECT PEOPLE WHO ARE AT SPECIAL RISK FROM CARBON MONOXIDE EXPOSURE BY REASON OF AGE, PREGNANCY OR MEDICAL CONDITION. IF IN DOUBT, CONSULT YOUR DOCTOR.

A CARBON MONOXIDE DETECTOR IS NOT A SUBSTITUTE FOR A SMOKE ALARM OR A COMBUSTIBLE GAS DETECTOR.

REPLACE UNIT AFTER 7 YEARS OF OPERATION.

7 Year Warranty

FireAngel Ltd warrants to the original purchaser that its enclosed carbon monoxide alarm be free from defects in materials and workmanship under normal residential use and service for a period of 7 (seven) years from the date of purchase. Provided it is returned with postage paid and proof of purchase date, FireAngel Ltd hereby warrants that during the 7 (seven) year period commencing from the date of purchase FireAngel Ltd, at its discretion, agrees to replace the unit free of charge. The warranty on any replacement CO-9D alarm, will last for the remainder of the period of the original warranty in respect of the alarm originally purchased – that is from the date of original purchase and not from the date of receipt of the replacement product. FireAngel Ltd reserves the right to offer an alternative product similar to that being replaced if the original model is no longer available or in stock. This warranty applies to the original retail purchaser from the date of original retail purchase and is not transferable. Proof of purchase is required.

This warranty does not cover damage resulting from accident, misuse, disassembly, abuse or lack of reasonable care of the product, or applications not in accordance with the user manual. It does not cover events and conditions outside of FireAngel Ltd's control, such as Acts of God (fire, severe weather etc.). It does not apply to retail stores, service centres or any distributors or agents. FireAngel Ltd will not recognise any changes to this warranty by third parties.

FireAngel Ltd shall not be liable for any incidental or consequential damages caused by the breach of any expressed or implied warranty. Except to the extent prohibited by applicable law, any implied warranty of merchantability or fitness for a particular purpose is limited in duration for 7 (seven) years.

This warranty does not affect your statutory rights. Except for death or personal injury, FireAngel Ltd shall not be liable for any loss of use, damage, cost or expense relating to this product or for any indirect, or consequential loss, damages or costs incurred by you or any other user of this product.

Ventilation

All caravans comply with BS EN 721. The ventilation points on your caravan are fixed points of ventilation which are required by the European Standards.

All caravans have ventilation at high level and low level which have been calculated to suit the individual needs of your caravan.

High level ventilation is achieved by means of the roof lights and washroom roof ventilators. The low level ventilators are positioned underneath the oven housing.

Under no circumstances must these vents be blocked or obstructed in any manner as this could lead to insufficient fresh air. In this case the confined atmosphere becomes depleted of oxygen which could lead to dangerous levels of carbon dioxide (CO₂) build up leading to risk of asphyxiation.

The risks of carbon monoxide (CO) build up, which is a colourless, odorless and tasteless gas, will also be reduced with ventilation. Carbon monoxide is produced from incomplete combustion and should the CO detector be activated the cause of the incomplete combustion must be investigated prior to reusing the appliance in question.

It is advised that fixed ventilation points are checked and cleaned (if necessary) on a regular basis using a small brush and a domestic vacuum cleaner.

Additional night time ventilation is obtained by releasing the window catches and placing them in the second groove. Note the windows are not sealed from rain in this position. As the ventilation levels are calculated to suit each models requirements there should be no modifications made which may result in reduced ventilation levels.

 **WARNING:** Do not obstruct ventilation

Petrol/Diesel Fumes

The fitting of a tail pipe extension to your car exhaust will reduce the possibility of fumes entering your caravan through the ventilation points.

Security

Caravan theft

The theft of a caravan can occur in the most unlikely circumstances; from a motorway service area, even from an owner's driveway.

Secure all windows and doors when your caravan is unoccupied even if only for a short length of time.

Security chips

A special security chip is concealed within the body of every caravan. This chip contains the individual identity of your caravan and can only be read by using a special decoder by police officers.

Chassis number

Your 17 digit serial number chassis number can be found on your windows and on the offside chassis member of the drawbar. It is also stated on the manufacturers weight plate next to the doorway.

Make a note of this number in the space provided at the front of this handbook and make a separate note of the number to keep safe at home.

Additional security

Consider fitting any device which might deter or prevent intrusion by thieves.

A hitch lock cover prevents towing of the caravan.

A wheel lock prevents towing of the caravan and removal of the wheel (some models are provided with an AL-KO Secure device).

Customers are advised to identify their caravan with a method for subsequent identification if other forms of identification have been altered or removed.

Free crime prevention advice about securing your caravan, protecting your valuables, property marking, either at home or whilst on site, can be obtained from the Crime Prevention Officer through your local Police Station.

Caravan insurance

It is recommended that the caravan and its contents should be insured against theft.

It is essential to check with your car insurance company to ensure you are covered when towing your caravan.

Swift Command Tracker by Sargent

A Swift Command Tracker is built in to your vehicle and forms part of the Swift Command system.

The unit is Thatcham Category 6 certified and is monitored by an approved monitoring centre which operates 24 hours a day 7 days a week and provides European coverage and direct police liaison.

This system is ready for use, all you need to do is purchase a tracking subscription by visiting www.swiftcommand.co.uk or calling Sargent on 01482 881655.

The subscription cost is £95 per year including VAT.

For more information please visit www.swiftcommand.co.uk

Operation

The Swift Command Tracker is easy to operate as it is controlled by the vehicle systems.

In a caravan the tracker is armed when the Stinger 310 / 350 Alarm System is armed. It is disarmed when the alarm is disarmed.

If the caravan doesn't have an alarm system fitted, a simple numeric keypad is used to arm / disarm the tracker. Enter your code followed by the ON button to arm the tracker.

Enter your code followed by the OFF button to disarm the tracker.

In a motorhome the tracker is armed / disarmed by the ignition key.

When the ignition is turned off the tracker is armed. When the ignition is turned on the tracker is disarmed.

SWIFT COMMAND TRACKER / AL-KO SECURE

Event of a Theft

If the vehicle is moved whilst the tracker is armed the geo-fence monitoring will trigger a theft event.

In addition to the above, in a caravan with the Stinger 310 / 350 Alarm System fitted, if the alarm is triggered by internal movement or caravan tilting the alarm monitoring will also trigger a theft event.

The monitoring station will now contact you to confirm the theft or false alarm. You will be required to confirm your identity against the information you provided when you subscribed.

If a genuine theft is confirmed the monitoring station will liaise with the police and keep you informed of progress.

Note; during a theft event to comply with legislation you will not be able to manually locate your vehicle using the Swift Command locate feature.

Contact

Before contacting any of the following please ensure you know your caravan or motorhome serial number. For caravans this is the last 10 digits if the CRIS number (like SWG0123456). For motorhomes this is the unique MH number (like MH01234).

The Swift Command Tracker monitoring station can be contacted on 0345 6027302. The stations operate 24 hours a day 7 days a week.

Sargent customer support can be contacted on 01482 678981 or via support@swiftcommand.co.uk

Telephone lines are manned during normal office hours.

Swift customer support can be contacted on 01482 875740 during normal office hours.

Precautions

The Swift Command Tracker monitors the leisure battery supply and if the voltage falls below a set level or the battery is removed this will trigger a fault event.

If you plan to remove your battery for maintenance or external charging please contact the monitoring station BEFORE removing the battery.

If you lose an alarm key fob you need to contact Sargent for a replacement and follow their instructions to remove the 'lost' fob from the system.

If you lose an ignition key you will need to visit a Fiat dealer for key replacement and removal of the 'lost' key.

AL-KO secure immobiliser

The AL-KO Secure immobiliser is fitted as standard on some models, optional on others. This is specific to alloy wheels and not compatible with steel wheels. The AL-KO part numbers for the scorpion design alloy wheel is as follows:

14" AL-KO part 1557076 (number 36) and 15" 155857 (number 34). The 4 part kit specified below will contain: -

Part A

Box containing security components, consisting of:

- 1 off High security locking bolt.
- 1 off High security locking bar socket key.
- 1 off Barrel lock.
- 2 off Barrel lock keys.
- Instruction manuals in CD and paper format.
- Security registration card and reference number.

Part B

Wheel specific insert assembly consisting of:

- Red coloured wheel insert lozenge assembled with the locking bar and clip.

Part C

- 1 off Wheel spanner.

Part D

- Kit bag.

Note: Two kits will be supplied with twin axle models.

You must register your key within one month of the date of purchase. Should you fail to do this, you will not be able to order a spare key!

- Within your AL-KO kit will find an exclusive security number.
- Please register your card by telephoning 0870 7576788 or 0044 1926 818500.
- You will need to provide a password and provide an answer to a prompting security question.
- Make a note of your password and keep it in a safe place.
- Keep your registration card safe.
- Take your registration card with you when you are travelling with the caravan.
- Always keep your registration separate from the lock.

Safety information (AL-KO secure)

- Always secure the caravan against rolling away (chock or couple to a towing vehicle).
- Always remove AL-KO Secure before moving the caravan.
- After any attempt of theft has been made on a locked AL-KO Secure, the caravan must be inspected at an AL-KO Approved Service Workshop.
- Always keep the key in a safe place.
- Keep the lock set and registration card separate from the key.
- The lock parts and key do not have a registration number, therefore keep the registration card in a safe place.
- Caravans with twin axles have two locks, keep each lock set in a separate place.

The sets are not interchangeable!

AL-KO operating instructions

- Read the AL-KO operating instructions and act in accordance with them.
- Follow all safety instructions as well as the warning information.

- It is recommended for ease of fit that a side-lift jack be used.

- Keep the operating instructions

The AL-KO side lift jack

The AL-KO Side Lift Jack has been specifically developed to aid the often difficult process of changing a wheel on caravans. It is suitable for fitment to the AL-KO chassis, located in the pre-drilled holes in the longitudinal members.

Note: The fitment of some aftermarket motor movers may inhibit the use of the AL-KO jacking system.

Mobile alarm system

Stinger 310 alarm (if fitted)



To ensure your STINGER 310 system is operated correctly, please read all sections of these instructions before attempting to use the alarm. If you are unsure of any content, please contact your dealer in the first instance or Sargents Electrical direct.

Operation - using the key fob

Each STINGER 310 is supplied with two key fob style radio controllers, which are used to operate the alarm system. Each key fob has four buttons which can be used as follows;



LED Torch button

Press and hold the button to use the torch for night time convenience



Arm / Disarm button

Press and release the button to arm the alarm (one beep)

Press and release the button to disarm the alarm (two short beeps)

ALARM / PIR SENSOR

To arm the alarm without the PIR movement sensor (if you leave pets inside etc)

Press and hold the arm button and release after you hear one beep followed by two beeps



Awning Light button

Press and release the button to turn the awning light on or off



Programming Mode button

Press and hold the button for 10 seconds to access the 3 programming modes, which are indicated by series of long beeps, as follows:

One long beep

- Tilt sensor sensitivity adjustment

Press the arm/disarm button to select the required setting. 1 beep = low sensitivity for windy conditions. 2 beeps = standard sensitivity (default). 3 beeps = High sensitivity. Press the program mode button to move to the next setting.

Two long beeps - Beeper volume

Press the arm/disarm button to cycle through the 7 available volume levels. When you are happy with the selected volume, press the program mode button to move to the next setting.

Three long beeps

- PIR movement detector sensitivity

Press the arm/disarm button to select the required setting / pulse count. 1 beep = high sensitivity 2 beeps = standard sensitivity (default). 3 beeps = Low sensitivity for hostile environments.

Press the program mode button again to exit programming mode, which is indicated by one extra long beep.

Operation - the PIR internal movement sensor

The STINGER 310 comes complete with a 120° Passive Infra Red (PIR) internal movement sensor that detects body movement within the vehicle.



If you are leaving pets within the vehicle the system should be armed without the PIR sensor active (see key fob arm/disarm section) to prevent your pet from triggering the alarm.

Please be aware that direct sunlight onto the PIR lens, or extremes of temperature (above 30 deg C) may affect the operation of the detector. Always ensure roof light blinds are closed if sunlight could shine directly onto the PIR.

Operation - the tilt sensor

The STINGER 310 incorporates a new electronic tilt and motion sensor with automatic calibration and easy sensitivity adjustment from the key fob. This feature provides excellent tilt detection with no moving parts.

The tilt sensor works automatically and does not need adjustment for normal use even if you park on a steep incline. The sensitivity of the sensor can be adjusted as described in the key fob programming section.

Operation - Awning light

When the STINGER 310 alarm system is armed or disarmed the Awning light will be activated for a period of one minute to provide illumination whilst entering or exiting the caravan. The Awning light can be turned off during this period by pressing the Awning light button on the key fob if required.

Battery - system base unit

The STINGER 310 system unit uses a special 4.8 volt Nickel Metal Hydride battery pack that supplies backup battery power to the system should the supply from the leisure battery fail or be disconnected.

It is recommended that the alarm system is permanently connected to a 12 volt supply. When fully charged the battery will provide approximately 6 months stand-alone operation, depending on temperature conditions. It is recommended that this battery pack is replaced every 3 years.

Before placing your caravan in storage please ensure the caravan has had a fully charged leisure battery fitted or the mains charger switched on for at least 14 days prior to storage to ensure the internal backup battery is fully charged. It is recommended that a leisure battery remains connected to the caravan during storage.

Always dispose of old batteries in accordance with local regulations.

Battery - key fob

The STINGER 310 key fob controllers use two lithium button cells (CR 2032) in each key fob. Please note that excessive use of the LED torch will reduce the life of the batteries considerably.

To replace the batteries, firstly remove the four cross head screws from the underside of the fob, then pull apart the two halves of the fob. Remove the used batteries from the lower half of the case, then insert the new batteries in the same manner, noting that the battery positive faces away from the green circuit board. Now reassemble the fob casing and refit the screws, taking care not to over tighten.

Alarm siren

The STINGER 310 contains a dual sounder unit that provides the loud alarm siren and the volume adjustable beeper sound.

When the alarm is triggered the siren will sound for 2 minutes. Following the 2-minute period the alarm will then deactivate for 15 seconds and then rearm.

The alarm siren can be turned off at any point by pressing the key fob arm/disarm button.

When the alarm is disarmed the Beeper will sound two beeps to confirm the disarm. If the alarm has been triggered during the armed period the beeper will sound three beeps if the PIR triggered the alarm or four beeps if the Tilt Sensor caused the alarm. If you hear multiple pips (short beeps) when you disarm the alarm, this indicated that the internal backup battery is low and therefore should be charged.

The beeper volume can be adjusted using the key fob programming feature described earlier.

System specification**System base unit:**

- Supply voltage 6 to 15v DC
- Supply current 500mA max 5mA typical
- Operating temperature -5 to +30 deg Celsius
- Battery capacity 9Ah at 4.8v
- Siren output 110dB +/- 10% @ 1M
- Comprehensive interface connector (details on request)

PIR movement sensor:

- Range 120 deg x 6M

Key fob controller:

- Range 6M typical
- Battery 2x CR2032 lithium button cell
- Typical battery life 1 year

Spare parts & service

The STINGER 310 system is supplied with two key fob controllers as standard, but can accommodate up to four controllers per system. Extra fob can be purchased from your supplier or direct from the manufacturer, and can be added to the system by following a simple procedure.

For accessories, interface harnesses, installation documentation, spare parts, local supplier contact details or other service information please contact: Sargent Electrical Services Ltd. service desk on 01482 678981 during normal office hours.

ALARM

Further technical information is available at www.sargentltd.co.uk

For your reference

For future reference it may be useful to note your alarm system serial number below, which can be found on the sticker attached to the alarm system base unit.

Serial number:

.....

Water System	54
Tank types	55
Plumbing connections	59
Plumbing troubleshooting	60
Fresh level sensor & cleaning	61
Sensor cleaning instructions	61
Water pump pressure switch	61
Water pump pressure switch adjustment	61
Ultraflow Water Intake Housing	62
Sanitising water system	63
Water Fault Finding	64
Typical gas schematic drawing	66
Gas	67
Types of gas	69
Gas safety advice	69
Awning space - ventilation	69
Changing a gas cylinder	70
Thermal insulation grades	70
Gas Fault Finding	71
Electrical system	72
Overseas connection	72
13 Pin tow vehicle connections	73
230V mains electrical equipment power consumption	74
Wiring of connecting cable and caravan mains inlet	75
Typical appliance consumption figures	76

WATER SYSTEMS

Water system- Introduction

All Swift Group caravans water systems have been designed around a pump fitted within the caravan. This pump draws water from an external source, to provide water pressure within the caravan, whenever it is switched on and water is available.

The schematic below shows the basic configuration of the water system with inboard pump and no internal water tank as applicable to **Sprite Freedom, Sprite, Challenger & Eccles, Conqueror & Elite**

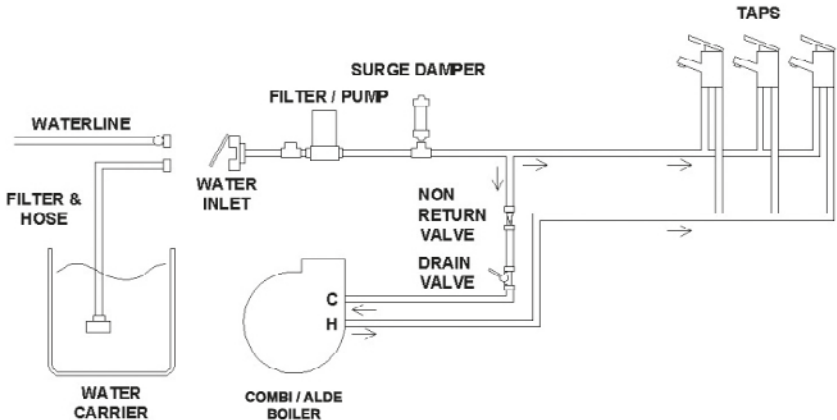

When power is supplied to the pump, it will draw water from the external container through the water inlet mounted on the side of the caravan, and pump it to the caravan taps, shower and water heater.

The pump is fitted with its own pressure switch, and the pump will continue to pump water, until the pressure of water on the output of the pump reaches a pre-set level. For this pressure to be achieved, the taps must be closed.

When the taps are opened, water will leave the tap via the spout, and the pressure in the pipes between the pump and the taps will reduce. Because of this reduction in pressure, the pressure switch on the pump will switch back on and the pump will again run to pump more water.

Close to the pump, the water under pressure is split into two paths:

1. Through blue water pipes routed directly to the cold connection of each tap.
2. To the water heater.

Water from the pump enters the bottom of the water heater. Once the water fills the water heater (typically 10 litres), water then leaves the water heater via a connection at the top of that water heater. This water, which is still under pressure, then routes to the hot connection of each tap via red pipes.

Tank types – Overview

No Internal Water Tank

A caravan water system with no internal water tank functions in the following way:

The inboard pump draws water into the caravan, via the inlet on the offside of the caravan. This is directed to the water heater, taps and shower. An umbilical hose, with baffle, is supplied with the caravan to connect between the inlet and an aquaroll or similar external container.

On Arrival at the campsite / Priming the system

- Ensure that the external water container is full.
- An umbilical hose with baffle is supplied with your caravan to connect between the inlet and aqua roll or similar container.
- Close all of the taps (kitchen sink, bathroom, shower) except one, which should be open in the hot position.
- Ensure that the water heater drain valve is closed (move the Yellow handle on the floor near the water heater to a horizontal position).
- Switch the pump on using the button on the control panel. Water will flow through the open tap after a short time. This tap can then be moved to the cold position and again after a short time water will flow.
- Repeat the procedure at each tap, including the external shower point (model specific)
- When using a mains water connection the pump will still need to be switched on to supply water to the water heater, taps and shower.
- If a mains water connection is used, please ensure this is a Truma Waterline connection, which has a built in pressure reducing valve.
- To drain / winterise the system please see separate details later in this handbook.

WATER SYSTEMS

Water system- with water tank

The following arrangement is used for a caravan with internal water tank as applicable to Elegance & Continental

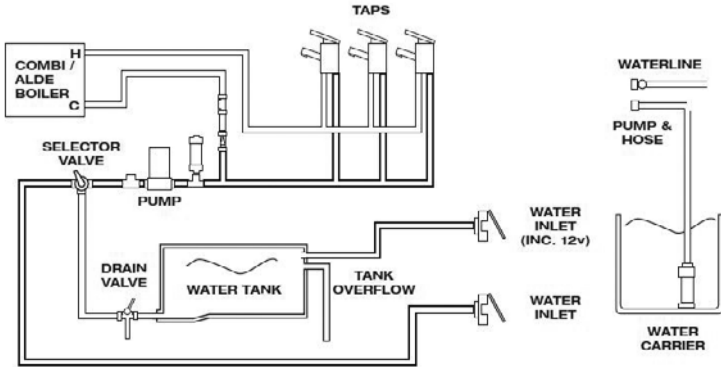
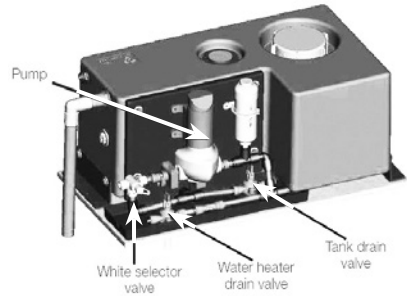

The control panel above the entrance door is used to control water pumps, and where applicable read water level displays.

- Two water inlets are fitted on the outside of the caravan, on the offside. The upper inlet is used to fill the internal water tank, and the lower inlet is used to bypass the tank.
- An external pump is supplied with the caravan, this can be used with the lower inlet when the onboard pump is being used to draw water from an external source.
- The same external pump can be used with the upper inlet, this will transfer water from the external source to the internal tank.
- A White selector valve located close to the pump is used to select the water supply from the external source or the internal tank (see valve positions on the next page). Please see the label on the bed flap rear, close to the tank

for valve operation. The label is also shown below.

The inboard pump draws water from whichever water source is in use.

When power is supplied to the pump, it will draw water from a selected source, and pump it to the caravan taps, shower and water heater. The pump is fitted with its own pressure switch, and the pump will continue to pump water, until the pressure of water on the output of the pump reaches a pre-set level. For this pressure to be achieved, the taps must be closed.

When the taps are opened, water will leave the tap via the spout, and the pressure in the pipes between the pump and the taps will reduce. Because of this reduction in pressure, the pressure switch on the pump will switch back on and the pump will again run to pump more water.

Close to the pump, the water under pressure is split into two paths:

1. Through blue water pipes routed directly to the cold connection of each tap.
2. To the water heater. Water from the pump enters the bottom of the water heater. Once the water fills the water heater (typically 10 litres), water then leaves the water heater via a connection at the top of that water heater. This water, which is still under pressure, then routes to the hot connection of each tap via red pipes.

INTERNAL TANK SUPPLY

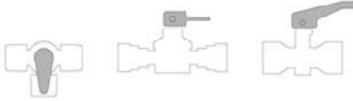

EXTERNAL SUPPLY



DRAIN SYSTEM

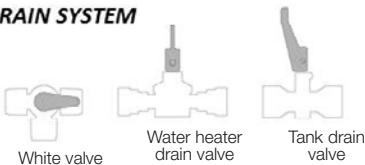

When using **EXTERNAL SUPPLY** ensure external pump is connected to lower outer socket. Upper socket is used only to fill internal tank

WINTERISATION / STORAGE

- 1) With external pump connected to upper external socket, lift the external pump out of the water container and allow the pump to run briefly.
- 2) Disconnect the external pump and set the valves to drain the internal tank and water heater, as shown opposite.
- 3) Open the kitchen tap, vanity tap, shower mixer and shower head to the fully open, mixed hot and cold position, and allow system to drain. Run the internal pump briefly.
- 4) Disconnect input and output connections to the internal pump and allow water to drain from connections (including filter body). Remove filter until further use.
- 5) Again run the internal pump for short time to expel any water from the pump body.
- 6) Unscrew shower head, or shower head and hose, and shake dry.
- 7) It is advised to leave the pump, and shower head and hose, disconnected until further use.

Please also check handbook and/or appliance manufacturers instructions for further winterisation advice

Note: The MRO is calculated with the fresh water tank empty. If you travel with water in the fresh water tank, the payload will be reduced accordingly.

WATER SYSTEMS

On Arrival at the campsite / Priming the system

The caravan water system can be used with or without the internal water tank. To use the caravan without internal water tank:-

- Ensure that the external water container is full.
- Connect the external pump to the lower connection point on the outside of the caravan, labelled 'direct to taps'.
- Move the white selector valve close to the pump anti-clockwise to select the external source
- Close all the taps except one, which should be open in the hot position
- Ensure that the water heater drain valve and tank drain valve are both in the closed positions (move the Yellow handles on the valves fitted near the tank to horizontal positions)
- Switch the pump on using the button on the control panel. Water will flow through the open tap after a short time. This tap can then be moved to the cold position again, after a short time, water will flow.
- Repeat the procedure at each tap, including the external shower point.

To use the caravan with the internal water tank

- Connect the external pump to the upper connection point on the outside of the caravan, labelled 'direct to tank'.
- Ensure that the tank drain valve (which is a Yellow handled valve identical in appearance to the water heater drain valve) is in the closed position- with the handle horizontal.
- Rotate the handle of the white selector valve clockwise to select internal tank as the water source.
- Use the control panel menu to switch on the external pump which will run for 7 minutes or shut off when this tank reaches full.
- Water will now be transferred from the external container to the internal water tank. The amount of water within the internal tank

can be checked by looking at the water gauge on the control panel.

- Once the control panel shows this level at 1/4 or higher, taps can be used as normal.
- Press the 'water pump' button to switch on the internal pump.
- When the control panel display shows the internal tank as full, or the external container if empty.
- Refill the external container.

To use the caravan with a mains water connection

- When using a mains water connection the pump will still need to be switched on to supply water to the water heater, taps and shower
- If a mains water connection is used, please ensure this is a Truma Waterline connection, which has a built in pressure reducing valve.
- The Waterline connection should be connected to the lower connection point on the outside of the caravan, labelled as 'direct to taps'.

Plumbing Connections

In most cases, speed fittings are used, which allow easy and quick connection of water pipes.

To connect a pipe to a fitting, simply push the pipe into the connector. To remove the pipe, push the collar of the fitting inwards, and then withdraw the pipe.

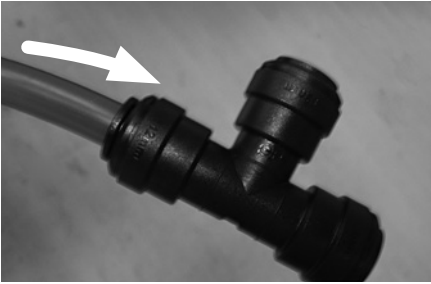

To connect a pipe, simply push the pipe into the connector.

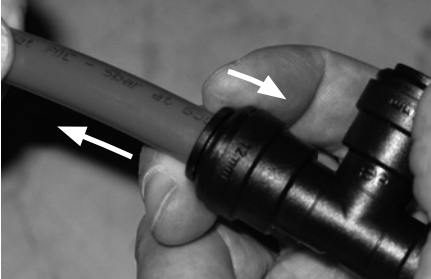

To remove a pipe, push the collar inwards, and then remove the pipe.

As a note, when refitting the pipe, ensure the end of the pipe is round (not oval) and the cut is square. If not, it could lead to water leaks.

Troubleshooting

Pump will not start, when the tap is opened:

- Check fuse(s).
- Check power source(s), and ensure there is sufficient voltage to run the pump.
- Ensure 'pump' LED is illuminated.
- Using a multi-meter, ensure there is power at the pump. If not, refer to your dealer as there maybe damaged cabling or a fault with the fusebox.
- Is the pump hot? If so, allow to cool before retrying.
- Has the vehicle been stored over winter? Was it correctly winterised? If no, the pump may have frozen, causing permanent damage.
- The pressure switch may need adjusting. See page 61 on how to do this.

Pump runs, but will not pressurise system (i.e. no or little water being discharged from taps) - Not Pulsing:

- Ensure water in source is present (onboard tank or aqua roll).
- Check in-line pump filter is free from debris and correctly fitted.
- Ensure water system has been primed correctly, (see page 58) and there are no air-locks present.
- Ensure there are no restrictions in the plumbing.
- Using a multi-meter, ensure there is power at the pump. If not, refer to your dealer as there maybe damaged cabling or a fault with the fusebox.
- Ensure the inlet side of the pump (including Truma inlet and in-line filter) are watertight and not allowing air into the system.
- Ensure the pump has good voltage.
- Check (using a multimeter) that the voltage at the pump is between 10v-14.5v.

Pump continues to run (for more than 5 seconds) after taps are closed or pump turns on for no reason:

- Check for leaks on the high pressure side of the pump.
- Ensure water system has been primed correctly, (see pages 58) and there are no air-locks present.
- Ensure the pump is securely mounted.
- Ensure the piping on the high pressure side of the pump is in good condition (not blowing or deforming).
- The pressure switch may need adjusting. See page 61 for information on how to do this.

Noisy or rough operation

- Check for leaks on the high pressure and low pressure side of the pump.
- Ensure that all pipes (especially those within 150mm of the pump) are not touching any furniture.
- Ensure the pump is securely mounted.

Pump rapidly cycles (switches on or off) or water pulses from taps, including temperature pulsing:

- Check for leaks on the high pressure and low pressure side of the pump.
- Ensure there are no restrictions in the plumbing
- The pressure switch may need adjusting. See Section (page 61) for information on how to do this.

Fresh level sensor & cleaning (when fitted)

Principle

The sensor, fitted to Swift Group caravans are pre-fitted to water tanks, and link to the fusebox, via a pre-fitted wiring harness. The sensors, which consist of a number of stainless steel rods or probes, at different lengths, are immersed in the fresh water, and use the conductivity of water, between the probes, to provide a reading to the fusebox.

The sensors are 'digital', in that while the conductivity (resistance) value can vary, the fusebox will register any conductivity between the reference probe and the various different length probes, indicating water present.

Normally, even if the rods are dirty, and providing the rods have not bridged by a foreign object, a circuit will still be delivered back to the fusebox and a water level displayed.

Sensor cleaning

The first step, in case of fault diagnosis, is to clean the sensor rods. False water level reading at the control panel can be caused by calcium build up or foreign objects within the tank bridging the probes.

Sensor Cleaning Instructions

Cleaning recommendations for lime scale build up:

1. Remove sensor from tank.
2. Check probes for build up or contamination.
3. Use clean soapy water.
4. Place scourer in water and dampen.
5. Apply scourer to sensor probe with limited pressure.
6. Rub sensor probe removing contamination.
7. Swill sensor with fresh clean water.
8. Replace probe into tank.

Suggested scourers - food safe

Plastic mesh scourer

1. Material: It is made of plastic.
2. Usage: Used for cleaning steel utensils, dishes, pots, pans, ovens, Bar-B-Que grills, glass, cutlery, sinks, kitchen and bathroom tiles and tubs etc.

Water pump pressure switch

The purpose of a pressure switch is to monitor the pressure on the outlet side of the pump. When a tap is closed, and the pump continues to run, there is an increase of pressure in the system, and when that pressure reaches a pre-set limit, the pressure switch will turn the pump off.

Water pump pressure switch adjustment

Pressure Switch Adjustment, Truma/Flo-Jet pump. (Normally Grey upper section with White lower section/valve housing)

- All of the Truma/Flo-Jet pumps used by Swift are pre-set at 25psi - 31psi.
- To further adjust the pressure switch setting, a cover cap must be first be removed from the end of the pump to reveal a pressure adjusting screw, as shown in the photos. A maximum of 1/4 turn clockwise or anti-clockwise, from the factory setting, is advised. Turning the screw clockwise 1/4 turn will increase the pressure switch cut-out pressure, turning the screw anti-clockwise will reduce the pressure setting.
- Please note a second screw mounted below the cover cap is set in position with threadlock, this should not be disturbed.

WATER SYSTEM

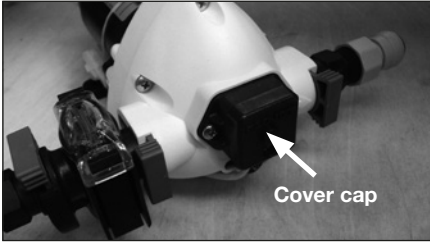

Cover cap

Pressure switch
adjusting screw**Ultraflow water intake housing****Operating instructions**

Raise the lid, clean both the water socket and the plug of the Intake Assembly.

Plug the intake connector into the socket.

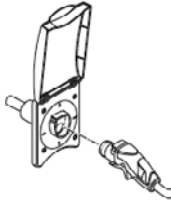

Place the assembly into the water container, ensuring that it is fully submerged before operating the system. The Dust cover is to stop contaminants falling into the water container.

When water is first introduced, or the water supply in the internal tank, or aquaroll, runs out, air will be present in the pipework. It is important that every tap is run to remove any air in the system before, for instance, the shower is used. Air left in pipework local to a tap can act as an accumulator and affect the ratio of hot and cold water flowing from other taps or shower mixers in the system.

If the pump fails to deliver water the most likely cause will be air in the system. Switch off the pump and shake the pump assembly in the external water container. Then switch on again.

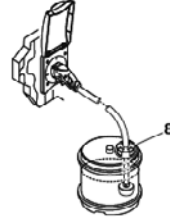

To remove the Intake Assembly from the Water Intake Housing. To remove, pull the lower trigger and pull out the hose plug.

⚠ WARNING: Do not remove by pulling the hose. Please ensure that the lid is properly closed before driving!

Routine maintenance

Ensure that the O-ring seal on the hose plug and the socket are free from dirt. To aid fitting of the plug assembly smear the O-ring with vegetable oil.

Notes

Before winter storage the water system must be completely drained (see winterisation / storage in the maintenance section).

Clean the water system at the start and end of the season with sterilising fluid (see notes under sanitising on the following page).

System care

Allowing water to freeze in the system may result in damage to the pump and plumbing system.

Non-Toxic antifreeze for potable water may be used with Truma pumps. Follow manufacturers recommendations.

⚠ WARNING: Do not use automotive antifreeze to winterize potable water systems. These solutions are highly toxic and may cause serious injury or death if ingested.

Sanitising

Guidance on cleaning portable water tanks and the water system in touring caravans.

The water systems, and in particular water tanks, in caravans are susceptible to contamination by bacteria if care is not taken with their use and cleaning. The symptoms caused by bacterial contamination are not purely limited to gastro-intestinal diseases, but may also manifest themselves as ear, nose, throat, eye or skin infections. It is therefore important that you carry out the following procedure prior to using the caravan each time, even if you boil or filter all water you use for drinking.

Separate Water Containers

1. All water remaining in the container should be disposed of so that the container is empty.
2. The outside of the container should be thoroughly cleansed and washed down to remove any dirt, dust or other contaminant. Water at a suitably hot temperature containing an appropriate detergent is recommended for this purpose.
3. Water should be put in the container, swirled around, then emptied out.
4. The container should then be totally filled with water containing an appropriate sterilant solution and allowed to stand for the recommended contact time.
5. The solution should be emptied from the container.
6. The opening of the container should be cleaned thoroughly with an appropriate prepared wipe impregnated with a sterilant.
7. The container should be inverted whilst stored overnight (if possible).
8. The container must be filled with mains water only and mains water only should be used for the above cleaning procedure.
9. On no account should garden hoses be used to fill water tanks.

For Systems:

1. Drain down the system (open all taps to allow air in, enabling the system to drain quickly).
2. Remove any after market water filters fitted, and replace with a short length of hose or empty filter cartridge (this will ensure the filter is not affected by the disinfectant/sterilant solution).
3. Fill the system by using the pump with a disinfectant/sterilant solution (check that the solution at full strength appears at all taps/showers). Allow to stand for the recommended period of time.
4. Drain the system completely.
5. Thoroughly clean the outside of all taps/connectors with a cloth soaked in the disinfectant/sterilant.
6. Flush the system through with clean drinking water until no traces of disinfectant/sterilant can be detected at any tap.
7. Replace the filter.

Suitable sterilising chemicals are available from your caravan dealer, accessory shop, chemist or home-brew shops. It is not, however, recommended to use bleach or sodium metabisulphite.

Do not use products that contain aggressive agents for sterilising the water system. Always use a product designed for use within stainless steel tanks available from your caravan accessory superstore.

NOTE: Never use the water heating system when disinfectant/sterilising fluid is present. Doing so may damage the system.

WATER FAULTS

Water

Fault	Cause	Remedy
Water not flowing from any tap when operated but pump runs	<p>Freshwater tank empty</p> <p>Pump wired in reverse</p> <p>Pipe inlet or outlet pipe disconnected</p> <p>Pump pipes restricted by kinking</p> <p>Blockage in pump inlet or outlet pipe</p> <p>Blocked in-line filter of pump filter</p> <p>Air leak in suction line to pump</p>	<p>Check</p> <p>Check wiring, refer to pump manufacturers instructions</p> <p>Check connections</p> <p>Check pipes run</p> <p>Check, starting inside freshwater tank</p> <p>Dismantle and clean</p> <p>Check for bubbles.</p>
Pump does not run	<p>Pump or tap incorrectly wired</p> <p>Pump fuse blown</p> <p>Battery disconnected</p> <p>Pump seized or overheated</p> <p>Pressure pump sensing switch may have failed</p> <p>Contacts may be faulty</p> <p>Wiring connections may be faulty</p>	<p>Refer to pump/tap manufacturers instructions</p> <p>Check wiring connection and then replace with fuse of correct rating</p> <p>Check connections</p> <p>Refer to pump manufacturers servicing instructions</p> <p>Refer to pump manufacturers servicing instructions</p> <p>Check contacts in plug and socket are clean and making contact</p> <p>Check wiring connections</p>
Water flows from cold tap but not from hot	<p>Feed pipe to water heater incorrectly connected to the heater outlet</p> <p>Blockage in hot pipeline</p> <p>Heater inlet or outlet pipes kinked preventing flow</p> <p>Hot tap not connected</p> <p>Hot tap failed or blocked</p> <p>Heater non-return valve jammed</p>	<p>Refer to installation instructions</p> <p>Disconnect pipes and inspect.</p> <p>Check and re-route if necessary.</p> <p>Check pipe and connect where required.</p> <p>Disconnect and inspect.</p> <p>Refer to dealer.</p>

Water

Fault	Cause	Remedy
Water flows from hot tap but has reduced flow from cold	Cold water pipe kinked preventing flow Blockage in cold pipe line Cold tap not connected Cold tap failed or blocked	Check and re-route if necessary Disconnect pipes after 1st connector and check up to tap Refer to installation instructions Disconnect and inspect
Reduced flow from both hot and cold taps	Battery condition low causing pump to run slowly If new taps have been fitted they may be restricting flow Pump needs servicing Partially blocked pump filter or in-line filter, if fitted Pump outlet pipe kinked restricting flow Water leak	Check battery state of charge, refer to electrical supply note Disconnect and check that they have at least 1/4" (6.3mm) bore Refer to pump servicing instructions Dismantle and clean if necessary Check and re-route if necessary Check all water connections
Reduced flow from either tap	Pipe kinking restricting flow	Check and re-route if necessary
If pump motor runs steadily and will not stop	Battery voltage may be too low (below 10.5 volts) Pressure Switch setting problem	Check that there is water in the container Adjust switch and/or re-charge battery Check all connections in pipework. Adjust settings.

GAS SCHEMATIC

Typical gas schematic drawing

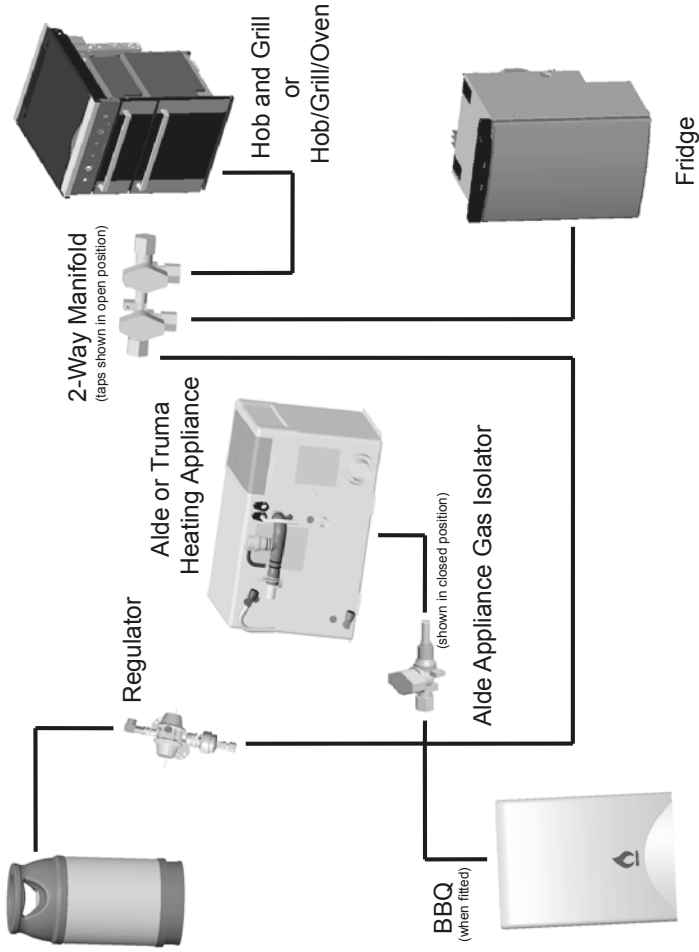

Note: Depending on the caravan model, the gas isolation tap for the water heater may be located close to the appliance.

Gas

General information

Gas Cylinders

Bottled Liquefied Petroleum Gas (LPG) is the most convenient portable source of fuel for your caravan. Make sure that heating and cooking appliances and the gas cylinders are switched off before you move the caravan.

Regularly check flexible gas hose, joints and connections for tightness.

Finally make sure that each gas appliance is working efficiently to the recommendations of the appliance manufacturers.

Only use gas bottle cylinders that are located within their dedicated position within the front gas bottle housing, never extend hose - hose lengths must not exceed 400mm.

Gas Hoses

A high pressure hose must be used with the regulator to connect to the gas bottle.

LPG cylinders i.e. Propane, Butane and Camping Gaz cylinders all have varying cylinder adaptor connections. It is important to check you have the correct hose and adaptor to suit your gas cylinders. Push on hoses are no longer permitted under the new regulations. The new high-pressure hoses have threaded connections and must be securely attached to the regulator and to the gas cylinder.

The pressure regulator relies upon a sealing washer(s) to maintain a gas tight joint, and it is essential to check that the washer is present, sound and correctly positioned prior to making the connection. The gas cylinder connection relies on a metal seating or bull nose connection to obtain a gas tight joint, therefore it is essential that the mating surfaces are clean and undamaged. In no case should a damaged valve or connection be used.

Ensure that there is a constant rise in the flexible gas hose between the gas cylinder outlet and the regulator elbow.

⚠ WARNING: Inspect flexible gas hose(s) regularly for deterioration and renew as necessary with the approved type, in any case no later than 5 years after the date of manufacture marked on the hose.

⚠ WARNING: Ensure hoses do not become entangled in door mechanism.

Cylinder compartment

All cylinder compartments have two universal plastic mouldings fitted to the floor of the compartment that are designed to fit both steel and BP Gas Light cylinders and two universal support cradles with straps for retaining the bodies of the cylinders at mid to high level and two universal support cradles with straps for retaining the bodies of the cylinders at mid to high level.

⚠ WARNING: Ensure that the hose assembly is not under stress when connected to the cylinder.

Regulators

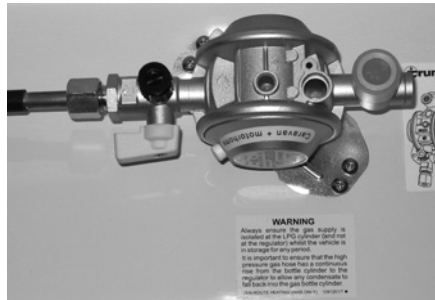

Your caravan is supplied with a wall mounted gas regulator plumbed inside the gas cylinder compartment. The regulator and all appliances work at a harmonised 30mb pressure, which work with Butane and Propane gas.

Pressure regulation system in this vehicle has a fixed working pressure of 30 mbar with a flow rate of 1.5 kg/h and complies with the requirements of EN 12864 annex D.

Note: Regulator valves and cylinder valves should always be in the 'OFF' position when towing and storage.

⚠ WARNING: When leaving the caravan for any period of time or storage always turn off the gas at the gas cylinder.

Note: Never allow modification of electrical or LPG systems and appliances except by qualified persons.

GAS HOSES

DuoControl (Model Specific)

The DuoControl combines the gas pressure regulator and the changeover valve in one unit for operation as a two-cylinder system. When the operating cylinder is empty, DuoControl automatically changes over to the reserve cylinder.

- Combines a gas pressure regulator and a changeover valve in one unit
- Automatically switches over to the reserve cylinder
- Complies with EN 13786

The Truma Drive Safe Regulator approved for en-route heating (model specific)

Fig. 1

Approved for en-route heating if your caravan has a factory fitted habitation en-route LPG heating system that can be used whilst travelling. Fig 1 shows the two safety valves features that are part of the system, these are there for your safety whilst using the system when travelling. When in use ensure all other gas appliances are separately isolated.

To use safety devices:

1. Open cylinder valve
2. Firmly press the hose rupture protection (green button) on the high pressure hose
3. If necessary (eg. after a new installation or inadvertently striking the gas cylinder against the gas pressure regulation system), press the green rest button (crash sensor triggering element reset) on the regulator

⚠ WARNING: Isolate cylinders when re-fuelling

General

Regularly check flexible gas hose, joints and connections for tightness. Finally make sure that each gas appliance is working efficiently to the recommendations of the appliance manufacturers.

The LPG system should be inspected annually by a competent person.

Only use gas cylinders that are located within their dedicated position within the gas bottle housing, never extend the hose - hose lengths must not exceed 400mm.

We do not recommend the use of an inline LPG BBQ when other LPG appliances are in use.

⚠ WARNING: Unless en-route heating is in use the LPG cylinder valve should be closed when driving.

Types of gas

Propane

Propane is supplied in red, or partly red bottles which have a female left hand threaded connector.

Scandinavian countries use the same connector.

Germany and Austria supply propane with a male connection.

Propane will work at temperatures as low as -40°C and is therefore suitable for all winter caravanning.

Butane

Butane is supplied in the U.K. in green or blue cylinder.

All these have a male left hand thread

EXCEPT for Camping Gaz which has a special female right hand thread and Calor 7kg and 15kg and aluminium cylinders which have a special clip-on connection.

Continental cylinders usually have a male left hand thread similar to but not identical with U.K. butane.

Butane is only suitable for use at temperatures down to 2°C and will not work below that.

Gas safety advice

⚠ WARNING: If you smell gas or suspect a leak or in the event of a fire and if it is safe to do so, isolate the gas appliances and turn off the gas bottles at the regulator. Evacuate the caravan and ventilate. Seek professional advice as to the cause of the leak.

Facts about LPG

- LPG is not poisonous.
- Bi-products are harmless.
- There is danger if all air and oxygen were excluded.
- (Ventilation holes must be kept clear at all times).
- LPG has been given a smell by the manufacturers in order to identify leaks.

Awning Spaces LPG Appliance Exhaust

There is no danger of pollution of an enclosed awning space by the LPG exhaust from a refrigerator venting into it, as awning spaces are generally well ventilated.

Space heaters may produce sufficient exhaust to pollute the awning space, if it is totally enclosed, from a general comfort, smell and hygiene point of view. In the extreme case there could be a build up of carbon dioxide to a dangerous level.

Caravan owners are advised to allow some fresh air circulation in the awning space when such appliances are in use.

Precautions

- Never look for a leak with a match. Always use a soap solution or its equivalent when testing connections. Do not operate any electrical apparatus whatsoever, especially light switches. If the leak is not obvious, the caravan should be evacuated and qualified personnel consulted.
- Avoid naked lights when connecting or changing a cylinder.
- Check the flexible hose frequently.
- The gas is heavier than air and therefore sinks to the lowest point.
- Keep bottle gas containers outside (and protected against frost). If they must be kept inside make sure they are well away from heat.

⚠ WARNING: Do not use appliances with a different working pressure to 30mbar.

⚠ WARNING: Maintain adequate spacing of combustible materials from sources of heat.

⚠ WARNING: Do not use independent portable gas appliances inside the vehicle. Cookers shall not be used as heaters

⚠ WARNING: A BBQ point inlet valve, if fitted, must only be used for the connection of portable LPG appliances.

GAS SAFETY

⚠ WARNING: Always read individual appliance instructions

Changing a Gas Cylinder

Please use the correct size spanner for the gas hose connectors as this will prevent damage to the screw fittings and ensure that the fitting is tightened sufficiently.

- Turn off all gas appliances
- Close the empty gas cylinder's valve.
- Remove the high pressure hose from the gas cylinders.
- Attach the high pressure hose to the full gas cylinder.
- Open the full cylinder's valve.
- Press the hose-break safety device.

Check the hose connection to the cylinder valve for leaks

Connection

Ensure that the gas regulator hose is correctly connected to the gas cylinder in gas bottle compartment and that the hose connection is tight.

Gas bottles must be fully located, seated at the base of the bottles and restrained by the strap provided in the dedicated compartment position. Straps are positioned to suit 6kg Calor Lite cylinders.

⚠ WARNING: If using cylinders other than those recommended, the user must ensure these are adequately supported, ventilation openings must not be obstructed and the cylinders must not cause damage to other fixtures and fittings located in the compartment.

Open ended gas hoses must always be protected from dirt and insects.

Before turning on the gas supply at the regulator, ensure that all gas operated equipment in the caravan is turned off.

All gas equipment (except barbecue and some water heaters) is supplied through a central Gas Manifold System which has

individual isolation taps for each appliance (Fig A), as follows:

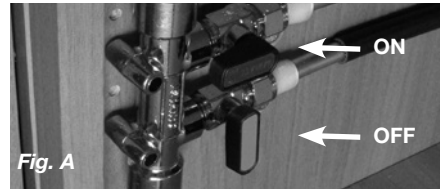

WHITE - Alde or Truma Boiler

BLUE - Fridge

GREEN - Oven

Note: the external barbecue point, when fitted, is fed from the main feed through a built in integrated isolation valve. See schematic layout for details (page 66).

Note: In some installations the water heater is fitted with a separate isolation valve.

Flue installations

All flue installations should be inspected once a year throughout their length for corrosion. Flues should be replaced if any sign of perforation is found. Ensure that the replacement is of an approved type and fitted by a qualified and competent person.

Thermal insulation heating

Your caravan has been designed and manufactured to a grade 3 thermal insulation and heating level for specific climatic conditions and tested according to the procedure in EN1645-1.

The classifications are as follows:

Grade 1

A caravan with an average thermal transmittance (u) that does not exceed 1.7w/(m²k).

Grade 2

A caravan with an average thermal transmittance (u) that does not exceed $1.7w/(m^2k)$ and which can achieve an average temperature difference of at least $20^{\circ}C$ between inside and outside temperatures when the outside temperature is $0^{\circ}C$.

Grade 3

A caravan with an average thermal transmittance (u) that does not exceed $1.2w/(m^2k)$ and which can achieve an average temperature difference of at least $35^{\circ}C$ between inside and outside temperatures when the outside temperature is $-15^{\circ}C$.

Your caravan has been tested to this grade.

GAS

Fault	Cause	Remedy
Hob does not light	No gas Air in pipe	Check level of gas in the cylinder Check gas cylinder valve is on Check gas taps are on Purge system Refer to hob manufacturers instructions
Oven does not light	No gas Air in pipe	Check level of gas in the cylinder Check gas cylinder valve is on Check gas taps are on Purge system Refer to oven manufacturers instructions
Alde or Truma boiler will not light.	No gas Over gassed Air in pipe	Check level of gas in cylinder Check gas cylinder valve is on Check gas taps are on Check exhaust outlet is clear Turn off appliance, wait 2 minutes and try again Purge system Refer to boiler manufacturers instructions
Fridge does not light	No gas Air in pipe	Check level of gas in the cylinder Check gas cylinder valve is on Check gas taps are on Purge system Refer to fridge manufacturers instructions

ELECTRICAL SYSTEM

The electrical system

General Information

It is strongly advised that the mains installation is inspected periodically to ensure safe use. The IET (BS7671) wiring regulations recommend that mains installations in touring caravans are re-inspected every 3 years.

The National Caravan Council lists the qualifications necessary to perform this inspection, but an NICEIC approved contractor is probably the first choice.

On arrival at the campsite

- Disconnect hitch and 13 pin plug from the towing vehicle.
- Place the 13 pin plug in the holder provided to prevent damage.



13 pin plug example

- Check the suitability of the supply, is it AC or DC, is the voltage and frequency correct.
- Ensure that there is a proper earth (3 pin socket outlet).
- If in doubt consult site staff.
- Make sure that the supply from the site is switched off.
- Make sure that the charger switch on the PSU is switched off.
- Lift the cover on the electricity inlet on the caravan, and insert the connector on the flexible supply cable.
- At the site supply point, connect the other end of the supply cable to this using the socket provided.

- Switch on the main switch at the site supply point.

Care point: It is good practice to test the RCD (Residual Current Device) in the PSU before switching on. There is a test button on the RCD to test the lever, put the lever in the up position (on) before testing.

Care point: As with the RCD it is good practice to check the Miniature Circuit Breaker (MCB) in the PSU. Switch all to the on position (lever up). If any do not stay up then there is a fault.

On departure from the campsite

- Switch off supply from the site, disconnect the cable at both ends.
- Switch off RCD.

⚠ WARNING: Current consumption in the caravan must not exceed 16 amps or the pitch permitted maximum if this is less than 16 amps.

Overseas connection

- Connection to a mains voltage overseas requires particular attention.
- Overseas supplies can be of reverse polarity.
- Reverse polarity results in equipment not necessarily being isolated when turned off, reverse polarity indicator on the PSU will light in the event of reverse polarity.
- The only sure way to make equipment safe is to unplug it.
- It is useful to have a means of checking polarity when overseas.
- If it can be achieved then connect live to live, and neutral to neutral to achieve full electrical protection.

⚠ WARNING: Never allow modifications of electrical or LPG systems and appliances except by qualified persons.

13 pin connection

When using the 13 pin connector system for the first time it is worth taking a few minutes to familiarise yourself with the basic features of the connectors.

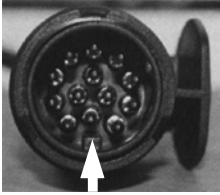

Fig. 1 - Correct alignment

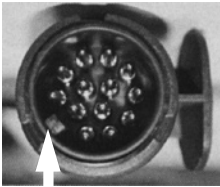

Fig. 2 - Incorrect alignment

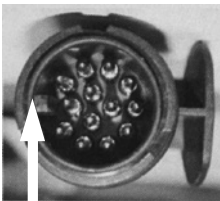

Fig. 3 - Incorrect alignment

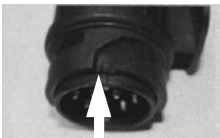

Fig. 4 - Alignment marks

The important difference with the new 13 pin plug, when compared to the old 12N/S type, is that the plug has an inner ring assembly that is independent from the outer body. Under normal circumstances the inner ring and the outer body will be locked in one position (see fig 1).

When the plug is first inserted in the socket body ensure that the locating protrusion (key) matches the groove (keyway) in the socket body. The outer body can then be rotated a

full 90 degrees clockwise until a click is felt or heard, at this point the cover flap can be allowed to fall over the circular surface of the plug top. (fig 6 & 7)

To remove the plug it is important to rotate the outer body a full 90 degrees anti-clockwise, again until a click is heard or felt before withdrawing the plug from the socket. This will ensure that the inner and outer parts of the plug are returned to a locked condition.

If the connector is not fully rotated anti-clockwise prior to removing it from the socket it is possible that the inner ring will become 'floating' and may result in a condition where the protrusion will be incorrectly aligned (see fig 2 & 3).

If this situation does occur then it can be corrected by inserting the edge of the protrusion on the plug into the groove in the socket (fig 8) and rotating the plug body anti-clockwise until a click is felt. This process will re-establish the lock between the inner and outer parts allowing the correct insertion of the plug into the socket.

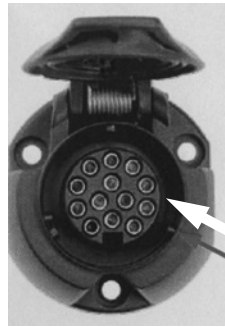

Fig. 5 - Socket body (containing female socket terminals) fitted to the car



Fig. 6

13 PIN CONNECTION

**Fig. 7****Fig. 8**

Plug inner ring
(containing
male pin
terminals fitted
to the caravan)

Plug outer
body with locating
groove and hood
fitted to the
caravan)

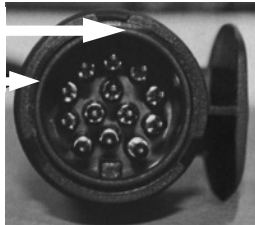
**Fig.9**

230V mains electrical equipment power consumption

Note: It is possible that the 230v mains electrical equipment may not all operate simultaneously. A typical UK site mains hook up point provides a maximum output of 10 amps and on some continental sites the available output may be as low as 5 amps. If your loading exceeds the site supply it may trip the site circuit breaker. Please check the available mains supply with your site operator.

Similarly loadings on each circuit breaker within the caravan should be observed. A label positioned close to the MCB's (Miniature Circuit Breakers) will identify which appliances within the caravan are fed from which MCB. Consulting the typical appliance consumption figures table in conjunction with this label, will give an indication of which appliances can, and cannot, (site supply allowing), be operated simultaneously.

WIRING OF CONNECTING CABLES AND CARAVAN MAINS INLET

Wiring of connecting cable and caravan mains inlet

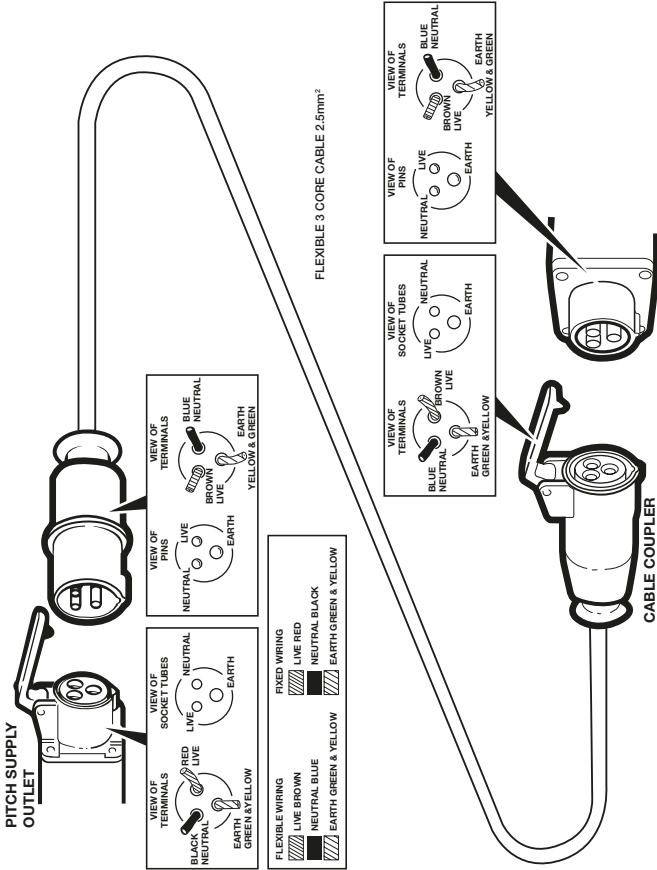

The legal length of the mains inlet cable is 25 ± 2 metres. When in use it must be fully uncoiled and protected from traffic.

TYPICAL APPLIANCE CONSUMPTION FIGURES

Typical appliance consumption figures

Appliances/ Item	230 Volt		12 Volt		LP Gas grams/hour
	Watts	Amperes	Watts	Amperes	
Dometic Refrigerator	190 W	0.8 amp	Only when driving		16 g/h
Tuma Combi 4kW Heating System	900/1800 W	3.9/7.8 amp	13W	1.1 amp (avg)	320 g/h
Tuma Combi 6kW Heating System	900/1800 W	3.9/7.8 amp	13W	1.1 amp (avg)	480 g/h
Aide Heating System	1050 / 2100 / 3150W	4.6 / 9.1 / 13.7 amp	12W	1.0 amp	245 - 460 g/h
Microwave (Factory fit)	1270W	5.5 amp	Not Applicable	Not Applicable	Not Applicable
Cooker - Hob burners	Not applicable	Not applicable	Not applicable	Not applicable	70 – 161 g/h
Cooker - Electric Hotplate	800W - 850W	3.5 - 3.7 amp	Not applicable	Not applicable	Not applicable
Grill	Not applicable	Not applicable	(cooling fan) 0-14.4W	(cooling fan) 0-1.2 amp	117 g/h
Oven	Not applicable	Not applicable	(cooling fan) 0-14.4W	(cooling fan) 0-1.2 amp	125- 146 g/h
Battery Charger	690W	3.0 amp	Not applicable	Not applicable	Not applicable
Ominvent	Not applicable	Not applicable	2 W- 86 W	0.2 amp - 7.2 amp	Not applicable
12V LED lights (each, depending in size of light)	Not applicable	Not applicable	0.4 W - 6.1 W	0.05 amp - 0.5 amp	Not applicable
Pressure switched pump	Not applicable	Not applicable	48 W	4.0 amp	Not applicable

Note: These are approximate figures for guidance only, and are subject to changes in specification. The figures show energy consumption when an item or appliance is operating – i.e. a light is illuminated, or a heating system is providing space heating or water heating. Appliances which feature LCD or illuminated control panels can have a low current consumption when in stand by mode, or have a constant low current draw in the background to run their displays and electronic systems - these figures are typically 0.4 amps or less, for each applicable item. These electronic items can in most cases be switched off individually, or, use of the System Shutdown button on the power supply unit isolates all of these items.

Swift Command Power Control System.....	78
Control Panel Operation	80
Residual Current Device & Miniature circuit breakers.....	83
Battery charger.....	84
Leisure Battery	84
12 Volt DC Fuses.....	86
Solar charge management.....	87
Smart charging.....	87
Water pump operation.....	87
Water tank heaters	87
AC current limiter operation	88
Lighting and dimming operation.....	88
Heating controls	89
Other controls.....	91
Additional CI Bus enabled devices.....	91
Bluetooth pairing	91
System warnings.....	92
Electrical faults.....	93
Remote access and control.....	96
Swift Command App	96
Swift Command web usage.....	96
Swift Command Sim coverage	96
Replacement parts	96
Updates	96
Technical Data & Approvals	97
Battery box	99
Battery installation	100
Solar panel energy system.....	101
Generator usage	102
Habitation relay.....	102
Exterior 230v socket.....	102
Internal USB socket.....	103

SWIFT COMMAND POWER CONTROL SYSTEM

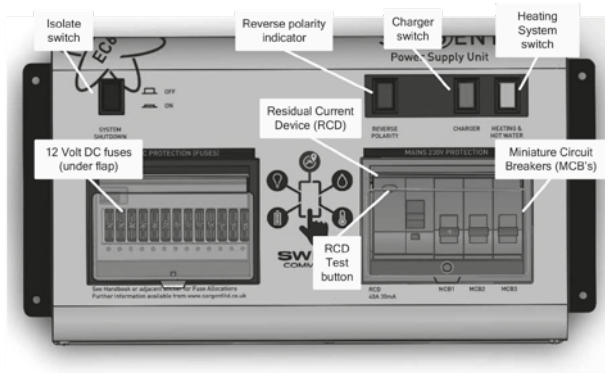

1. Introduction

This section of the handbook will guide you through the operation of the electrical system.

Further technical details are contained in section 3 or in the supporting technical manual available from www.sargenttd.co.uk

For the safe operation of all electrical equipment within your Leisure Vehicle it is important that you read and fully understand these instructions. If you are unsure of any point please contact your dealer / distributor for advice before use.

The system has a number of key components that you will need to be familiar with before attempting to use the system, these are:

- The EC601 & EC651 Power Supply Unit (PSU) - a combined mains consumer unit and 12V controller located in the bed box or mounted in furniture.
- The EC620 Control Panel (CP) - a remotely located user control panel used to turn circuits on and off and to display battery, water tank and other system information. This panel uses simple straightforward controls and reliable data communication to the PSU.

- The PX300 Intelligent Battery charger 300W
- The C44 Road Light Fuse Box - This small unit, is located in the front bed box. The unit houses fuses for the road lighting circuits and supplies from the tow vehicle, and also has connectors for the optional alarm system and Automatic Trailer Control (ATC) unit.

2. Using the System

2.1 Power Supply Unit - Component Layout

The PSU is located in the front offside bed box or is mounted into furniture.

2.2 Activating the System

The EC600 system has a shutdown feature that can be used when the vehicle is in storage. This allows the leisure electronics to be turned off when not required to save battery power. When in the off state the alarm and tracking system supplies are still active, all other supplies are turned off.

Before using the system please ensure the system shutdown switch is in the on position (button in).

2.3 Connecting to the Mains 230V supply and Safety checks

For your safety it is IMPORTANT that you follow these connections instructions each time your Leisure Vehicle is connected to a mains supply. This section assumes that the system is complete and that a Leisure battery has been installed (see 3.4).

A) Ensure suitability of the Mains Supply.

Your Leisure Vehicle should only be connected to an approved supply that meets the requirements of BS7671 or relevant harmonised standards. In most cases the site warden will hold information regarding suitability of supply. If using a generator you also need to comply with the requirements / instructions supplied with the generator. Please note that some electronic generators may not be compatible with your leisure system. Further generator operational information is contained elsewhere in this manual.

B) Switch the PSU internal Power Converter OFF.

Locate the green 'Charger' power switch on the PSU and ensure the switch is in the off position (button out) before connection to the mains supply.

C) Connect the Hook-up Lead.

Firstly connect the supplied hook-up lead (orange cable with blue connectors) to the Leisure Vehicle and then connect to the mains supply.

D) Check Residual Current Device operation.

Locate the RCD within the PSU and ensure the RCD is switched on (lever in up position). Press the 'Test' button and confirm that the RCD turns off (lever in down position). Switch the RCD back to the on position (lever in up position). If the test button failed to operate the RCD see section 3.18.

E) Check Miniature Circuit Breakers

Locate the MCB's within the PSU (adjacent to the RCD) and ensure they are all in the on (up) position. If any MCB's fail to 'latch' in the on position see section 3.18.

F) Turn the PSU ON.

Locate the black 'Shutdown' button and ensure it is in the on position (press button in). Locate the green 'Charger' switch on the PSU and turn to the on position (press button in). The charger switch will illuminate when turned on.

G) Check correct Polarity.

Locate the 'Reverse polarity' indicator on the PSU and ensure that the indicator is NOT illuminated. If the indicator is illuminated see section 3.18.

H) Check operation of equipment.

It is now safe to operate the 12V and 230V equipment.



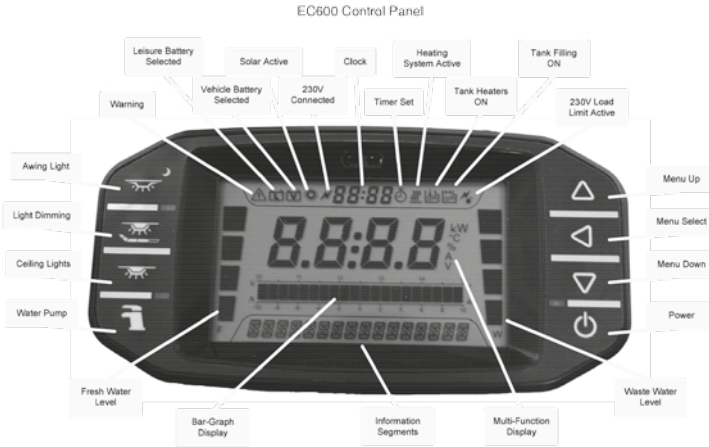

SWIFT COMMAND POWER CONTROL SYSTEM

2.4 Control Panel - Component Layout

Your control panel will have an appearance as below, but depending on your type of vehicle features will vary. Not all features are present in all vehicles.



2.5 Control Panel Operation

	Power Button. Press the power button to turn the leisure power on. Press the button again to turn the power off. The adjacent LED will illuminate when the power is on, the screen backlight will turn on and system information will be shown on the LCD display. To avoid night time nuisance the LED and backlight will be turned off after a preset time, see note below.
	Menu Navigation Up Button. Use the menu up and down buttons to scroll through the various functions. The menu operates on a continuous loop arrangement so you can go up or down to reach all menu items. It is recommended to start in the down direction.
	Menu Navigation Select Button. Use the select button make a selection or to change a value or setting. This button is also used to select the display or toggle the display information on many menu items.
	Menu Navigation Down Button. Use the menu up and down buttons to scroll through the various functions. The menu operates on a continuous loop arrangement so you can go up or down to reach all menu items. It is recommended to start in the down direction.







Menu Tree



- **Leisure battery**, the leisure battery voltage and charging or discharging current is displayed. Use the select button to toggle the display, with voltage on the main display whilst current (in or out of the battery) is shown on the bargraph and vice-versa, current on the main display and voltage on the bargraph.
- **Vehicle battery**, when connected the vehicle battery voltage and charging or discharging current is displayed. Use the select button to toggle the display, with voltage on the main display whilst current (in or out of the battery) is shown on the bar-graph and vice-versa, current on the main display and voltage on the bar-graph.
- **Solar Power**, the charging current from the solar panel along with the voltage of the battery it is charging is displayed. Use the select button to toggle the display, with voltage on the main display whilst current is shown on the bargraph and vice-versa, current on the main display and voltage on the bargraph.
- **Select Battery**, press the select button toggles between the Leisure and Vehicle batteries as the power source (or battery to be charged). The selected battery is shown in the header area.
- **Tank-Fill on/off**, Turn tank fill on to start the external water pump and to start transferring water from the external water container to the internal water tank. Tank filling will stop when the onboard tank is full or if more than 7 minutes have elapsed.
- **Tank Heaters on/off**, is not applicable to caravans and will appear on the menu.
- **AC Limit**, the AC current limiter, when enabled, will monitor the incoming AC current and if the set limit is reached the 230V heating element within the heating system will be temporarily turned off until the current falls below the set limit. Use the select button to set the limit or to turn the feature off. The AC Limit icon in the header indicated that a limit is set and will flash if the limiter is active.
- **Temperature & Humidity**, Pressing the select button scrolls through the internal temperature, internal humidity & external temperature readings. Please note that due to the location of the internal temperature sensor there may be slight differences to the temperature shown on the heating system.
- **Dimmer %**, this display shows the lighting dimming level and is adjusted in 5% increments. The display commences where the level was last set. Press the select button to increase the level up to 100% and then back down again to 5%. Pressing the dimming button on the control panel immediately shows this dimming value.
- **Heater Settings**, this sub menu allows the heater controls and associated settings to be adjusted. A full explanation of the controls can be found in the heater section.
- **System Settings**, this sub menu allows a number of system features to be configured like the Clock, Date, Key beep, Backlight time, LED time, Tank Alarms, Bluetooth Pairing etc.

SWIFT COMMAND POWER CONTROL SYSTEM

	Pump Button. With the power on, press the pump button to turn the water pump on. Press the button again to turn the pump off. The adjacent LED will illuminate when the pump is on and the level of the water tank will be shown on the screen.
	Interior Lights Button. With the power on, press the lights button to turn the main lighting supply on or off.
	Light Dimming Button. With the power on, press the dimmer button to turn the dimmed lighting on or off. Press the select button to adjust the dimmer level (the menu automatically changes to the adjustment screen). The last setting is remembered.
	Awning Light Button. With the power on, press the awning light button to turn the awning light on or off. The Adjacent LED will illuminate when the awning light is on. The awning light may also be controlled by a door slide, or caravan alarm system if fitted.

Note, display illumination. The LCD back light will illuminate for the pre-set time (default time is 30 seconds) adjustable between 5 and 120 seconds. Setting the timer to 0 seconds will force the backlight to be permanently on. The illumination of the blue LED's adjacent to the power, pump & awning light buttons can be configured in the same way as the backlight. The screen will wake up if your hand is placed near the panel or if a button is pressed.

2.6 Operation while driving

The EC600 system is designed to shutdown parts of the system while the engine is running. This is to meet Electro Magnetic Compatibility (EMC) regulations and to ensure the safe operation of the caravan.

Please ensure the system shutdown switch on the PSU is in the on (button in) position before towing (see 2.2). This will ensure the electronic system is active and will therefore be able to control the charging process, supply the refrigerator and monitor other system circuits.

With the engine running the screen will show ENGINE RUNNING, the leisure and vehicle battery icons will be displayed to indicate they are being charged and the charging voltage will be shown in the main display.

3 System Technical Information

The following section provides further technical information relating to the electrical system.

You can also access the supporting technical manual from www.sargentltd.co.uk

3.1 Residual Current Device & Miniature Circuit Breakers

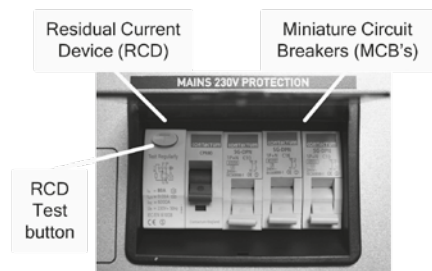

The Residual Current Device (RCD) is basically provided to protect the user from lethal electric shock. The RCD will turn off (trip) if the current flowing in the live conductor does not fully return down the neutral conductor, i.e. some current is passing through a person down to earth or through a faulty appliance. To ensure the RCD is working correctly, the test button should be operated each time the vehicle is connected to the mains supply (see section 2.3)

The Miniature Circuit Breakers (MCB's) operate in a similar way to traditional fuses and are provided to protect the wiring installation from overload or short circuit. If an overload occurs the MCB will switch off the supply. If this occurs you should investigate the cause of the fault before switching the MCB back on.

The following table shows the rating and circuit allocation for the three MCB's

MCB	Rating	Output Wire Colour	Description
1	10 Amps	White	230V Sockets
2	16 Amps	White (Yellow for heater)	Extra 230V Sockets / Alde or Truma Heating System / Whale Space Heater
3	10 Amps	Black (Blue for Whale water heater)	Fridge / Charger / Auxiliary devices / Whale Water Heater

3.2 Generator Usage

Caution should be used before connecting a generator to your caravan.

⚠ WARNING: Never start or stop the generator while electrical loads are connected and switched on. Start the engine, let it stabilise and then connect the electrical load. To stop the engine, disconnect the electrical load and let engine stabilise before switching off

Whilst some generators use electronic inverter technology, others use a more basic principle to generate the 230V supply. Preference should be to choose a generator which produces a consistent sinusoidal wave form with accurate voltage control.

The Reverse Polarity warning light on the PSU may illuminate when using a Generator. This is a normal side effect when using some types of generator. Instead of connecting the neutral conductor to earth, some generators centre tap the earth connection making both neutral and live conductors 110V above earth. This 110V difference causes the neon polarity indicator to illuminate.

In most cases it is safe to use a generator, but please consult the generator handbook for further information.

SWIFT COMMAND POWER CONTROL SYSTEM

3.3 Battery Charger

The system incorporates an intelligent three-stage battery charger.

During stage 1 the battery voltage is increased gradually while the current is limited to start the charging process and protect the battery. At stage 2 the voltage rises to 14.4V to deliver the bulk charge to the battery. When the battery is charged, the voltage is decreased at stage 3 to 13.6V to deliver a float charge to maintain the battery in the fully charged state. The charger can be left switched on continuously as required.

The battery charger / power converter also provides power to the leisure equipment when the mains supply is connected. This module supplies DC to the leisure equipment up to a maximum of 25 Amps (300 Watts), therefore the available power is distributed between the leisure load and the battery, with the leisure load taking priority as per the following example:

Leisure Load	Available power for battery charging
5A	20A
10A	15A
15A	10A
20A	5A

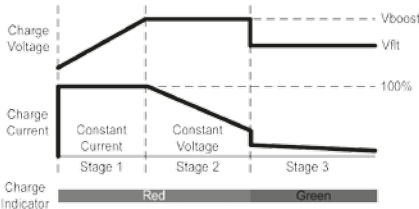

⚠ WARNING: Under heavy loads the Battery Charger case may become hot. ALWAYS ensure the ventilation slots have a clear flow of air. Do not place combustible materials against / adjacent to the charger.

3.4 Leisure Battery

A) Type / Selection

For optimum performance and safety it is essential that only a proprietary brand LEISURE battery is used and it is suggested to select a battery from the NCC Verified Battery Scheme with a typical capacity of 75 to 120 Ah (Ampere / hours). Depending on the prospective use of the caravan the correct type should be selected (A, B or C). A normal car battery is NOT suitable. This battery should always be connected when the system is in use.

The PSU is configured to work with standard lead acid leisure batteries, and in most cases is also compatible with the latest range of Absorbed Glass Matt (AGM) batteries. Before fitting non-standard batteries please check that the charging profile described in 3.3 is suitable for the type of battery by referring to the battery documentation or battery manufacturer.

Some vehicle installations can cater for two leisure batteries connected in parallel. In these cases it is recommended that two identical batteries are used. The battery feed is fitted with an inline fuse between the battery and the electrical harness, and is usually located immediately outside the battery compartment or within 500mm of the battery. The maximum rating of this fuse is 20A per battery. If two batteries are fitted each battery should be fused at a maximum of 20A.

B) Installation & Removal

Always disconnect the 230V mains supply and turn the PSU green charger switch to the off position (button out) before removing or installing the battery.

When connecting the battery, ensure that the correct polarity is observed (black is negative [-] and red is positive [+]) and that the terminals are securely fastened. Crocodile clips must not be used.

⚠ WARNING: Explosive gases may be present at the battery. Take care to prevent flames and sparks in the vicinity of the battery and do not smoke.

⚠ WARNING: Your caravan is fitted with Swift Command Tracker (by Sargent) which monitors battery voltage. If you plan to disconnect or remove your leisure battery for maintenance or external charging, then please contact the monitoring station before you remove or disconnect the battery. If a leisure battery is not fitted, please also contact the Tracker monitoring station before removing the mains hook up. The Swift Command Tracker monitoring station can be contacted on 0345 6027302.

Note: Do not over discharge the battery. One of the most common causes of battery failure is when the battery is discharged below the recommended level of approximately 10V. Discharging a battery below this figure can cause permanent damage to one or more of the cells within the battery.

To prevent over discharge, the EC600 system incorporates a battery protect circuit that warns the users and then disconnects the batteries when they fall below set values.

If a warning is active a beep will be emitted by the control panel and information will be shown on the screen. To cancel the warning, press the select button. These warnings will not be repeated unless the power switch is turned off and on again. This is to ensure the warning does not become a nuisance.

C) Operation / Servicing

Under normal circumstances it should not be necessary to remove the battery other than for routine inspection of the terminals and “topping up” of the battery fluid where applicable. Please see instructions supplied with the battery.

Battery	Voltage cut off	Action after cut off	Notes
Vehicle	10.9V	Battery selection is changed from Vehicle battery to Leisure battery. If the leisure battery is below 9V then a further warning will occur (see below).	This cut off level is designed to protect the vehicle battery from over discharge. The 10.9V level ensures there is sufficient power in the battery to run the vehicle electronics and start the vehicle. This cut off only applies to power drawn from the battery by the leisure equipment; it will not protect the battery if you leave vehicle circuits switched on, such as the road lights.
Leisure	9V	Power is turned off	This is an emergency cut off level to protect the battery from severe damage. You should not rely on this cut off level during normal operation, but manage your power consumption to a discharge level of about 11.5V. This cut off only applies to power drawn from the battery by the leisure equipment that is controlled by the control panel power switch; it will not protect the battery from discharge by permanently connected equipment.

SWIFT COMMAND POWER CONTROL SYSTEM

3.5 12 Volt DC Fuses

⚠ WARNING: When replacing fuses always replace a fuse with the correct value. NEVER replace with a higher value / rating as this could damage the wiring harness. If a replacement fuse 'blows' do not keep replacing the fuse as you could damage the wiring harness. Please investigate the fault and contact your dealer.

Fuse	Rating	Fuse Colour	Description
1	25 Amps	White	Charger
2	7.5 Amps	Brown	Permanent 12V / Alarm / Fridge Electronics / Alde Heating
3	10 Amps	Red	12V Sockets / TV Amplifier / Radio
4	10 Amps	Red	Extractor Fans / Truma Heating / Whale Space Heater
5	5 Amps	Tan	Appliances / Hob Ignition / Toilet / Whale Water Heater
6	10 Amps	Red	Water Pumps
7	7.5 Amps	Brown	Lighting, Main Lights & Dim Channel 1.
8	5 Amps	Tan	Lighting, Entry Light & Dim Channel 2.
9	10 Amps	Red	Spare Outputs / Motorhome only
10	10 Amps	Red	Auxiliary / Awning Light / Electric Step (Motorhome only)
11	20 Amps	Yellow	(Motorhome only)
12	15 Amps	Blue	(Motorhome only)
13	15 Amps	Blue	(Motorhome only)

Note: Fuses (2-13) have a Red LED below them which provides indication that the fuse has blown. The charger fuse has a green LED which indicates that the charger is working.

The following table shows details of the fuse(s) located at the Leisure battery. See also 3.4A

Fuse	Rating	Fuse Colour	Description
Battery	20 Amps	Yellow	Fuse remotely located near battery

The following table shows details of the fuse(s) located at the Road Light fuse box.

Fuse	Rating	Fuse Colour	Description
1	20 Amps	Yellow	Fridge Supply
2	5 Amps	Tan	Left Hand Tail Lights
3	5 Amps	Tan	Right Hand Indicators
4	5 Amps	Tan	Fog Lights
5			Spare location
6	20 Amps	Yellow	Car Battery Supply
7	5 Amps	Tan	Right Hand Tail Lights
8	5 Amps	Tan	Left Hand Indicators
9	7.5 Amps	Brown	Stop Lights
10	5 Amps	Tan	Reverse Lights

3.6 Solar Charge Management

The EC601/651 PSU incorporates a built-in solar charge management feature, which will monitor the input from a separate solar panel and regulator. The Solar Active symbol will be displayed on the control panel when there is an amount of energy available to charge the battery. The voltage and current produced from the regulator can be viewed on the multi-function display by selecting the Solar Power menu item. A maximum of 150w of Solar Charge can be connected in this way.

3.7 Smart Charging

Distribution of charger output to vehicle and leisure batteries is not applicable to caravans.

3.8 Water Pump Operation

The EC620 control panel pump button operates the internal water pump drawing water from an internal tank if fitted, or an external container when no internal tank is fitted.

The system incorporates an automatic tank fill feature. When turned on this will automatically fill the onboard water tank from the external container and will switch off automatically when full. To enable tank fill, select 'Tank-fill on' on the control panel.

To ensure the external pump is not damaged if the external tank runs dry, the pump runs for a maximum of 7 minutes.

When an inboard fresh water tank is fitted, the water tank incorporates a level warning feature to warn the user when the fresh water level drops below 25%.

If the water pump power is turned on and the fresh water level drops to below 25% a warning beep will be heard and a message will be displayed on the control panel. To cancel the warning, press the select button.

This warning will not be repeated unless the water pump power switch is turned off and on again. This is to ensure the warning does not become a nuisance.

The Swift Command App can be used to control the pump.

3.9 Water Tank Heaters (frost protection) Operation

Tank heater fitment is not applicable to caravans.

3.10 AC Current Limiter Operation

The EC600 system features a 230V current monitoring system which allows the mains hook up current to be displayed on the control panel. The resolution of this reading is 0.5A. A current limit setting can be activated which if reached will switch off the electric elements in the heating system, until such time as the current drops and the elements will be switched back on. An example of this is if a kettle was to be operated whilst the heating was on and the current limit was reached: The heater electric element would be temporarily switched off, when the kettle had boiled then the heater element would be switched back on automatically.

This feature is particularly useful when abroad on a low current supply. A warning that the limit has been reached is displayed on the control panel.

Setting the value to OFF will disable this feature. The Smart Command App can be used to adjust this feature.

3.11 Lighting & Dimming Operation

The system contains up to two dimming channels for groups of lights which can be controlled by the light dimming button on the control panel, and the furniture mounted controls for those lights. Some caravan layouts have only one group of lights which can be dimmed.

The awning light on a caravan can be controlled by a number of items within the caravan, the local switch adjacent to the entry door, the alarm system lighting button, the control panel awning light button and the App. Each item can toggle the light on and off.

The Smart Command App can be used to both configure and adjust the lighting and dimming.

3.12 Heating Controls

There are a number of heating systems that can be controlled by the EC600. The system will be preconfigured by the manufacturer. The following menu items are only available in Timer control mode, and 3 examples are shown for the different heating system variants.

Scroll to the Heating Settings and press select to set or adjust the following items:

ALDE 3020		
Menu Item	Description	
Control	Set to MANUAL to use the controls supplied by the heating appliance manufacturer. Set to TIMER to control the appliance by the control panel with the settings below. Set to APP control the appliance by the Smart Command app. <i>To allow Swift Command control of the heating system, the '3rd. Party Panel' option on the Alde Controller must be enabled. This should already be set up for you on your motorhome or caravan. See Alde instructions for further details.</i>	
<i>The following menu items are only available when in Timer control mode.</i>		
Electric	Set the electric element to OFF, 1KW, 2KW or 3KW	
Gas	Set gas heating ON or OFF	
Timer 1	Set the timer 1 event time. This setting adjusts in 15 minute increments and uses the 24 hour clock	Example 07:30
T1 Heating	Set the timer 1 heating temperature. This setting can be off, or 5 through to 30 degrees C	Example 22 deg C
T1 H/Water	Set the timer 1 hot water temperature. This setting can be OFF, NORML or BOOST	Example Boost
<i>The menu now repeats for timer 2 through to timer 4</i>		
Exit settings?	When timer 4 is completed the exit settings item is reached. Press the select button to exit and save the settings.	

The timer example above will set the heating to 22 degrees C and the hot water to eco at 7:30 in the morning.

SWIFT COMMAND POWER CONTROL SYSTEM

TRUMA Combi CP+		
Menu Item	Description	
Control	Set to MANUAL to use the controls supplied by the heating appliance manufacturer. Set to TIMER to control the appliance by the control panel with the settings below. Set to APP control the appliance by the Smart Command app. <i>To allow Swift Command control of the heating system, the Combi Controller must be initialised while Swift Command is active. This should already be set up for you on your motorhome or caravan. See Truma Combi CP Plus instructions for further details.</i>	
<i>The following menu items are only available when in Timer control mode.</i>		
Energy	Set the energy selection to GAS, MIX1, MIX2, EL1 or EL2. See the heater user manual for a description of these settings.	
Timer 1	Set the timer 1 event time. This setting adjusts in 15 minute increments and uses the 24 hour clock.	Example 07:30
T1 Heating	Set the timer 1 heating temperature. This setting can be off, or 5 through to 30 degrees C.	Example 22 deg C
T1 H/Water	Set the timer 1 hot water temperature. This setting can be OFF, ECO or HOT.	Example Eco
<i>The menu now repeats for timer 2 through to timer 4</i>		
Exit settings?	When timer 4 is completed the exit settings item is reached. Press the select button to exit and save the settings.	

The timer example above will set the heating to 22 degrees C and the hot water to eco at 7:30 in the morning.

3.13 Other Controls

The main control panel will display the software version number of both the Control Panel and the PSU. On the EC620 menu item press the select button to display software information.

3.14 Electric Step operation

Electric step operation is not applicable to caravans

3.15 Additional CI Bus Enabled Devices

The Swift Command system will continue to develop enabling the control of additional devices such as air conditioning and control units. When selecting additional equipment check for CI Bus compatibility markings, and check with Sargent Electrical for details of the latest compatible devices.

3.16 Bluetooth Pairing

Using the control panel, access the System Settings menu and then scroll to the Bluetooth pairing section. Press the select button to start pairing, the power button LED will flash to indicate the pairing mode. You can now pair your device to the system following the devices instructions to add a Bluetooth item. Pairing remains on for 1 minute and is then turned off automatically.

3.17 System Warnings

The system incorporates a number of warnings that are active at specific times. These are summarised below, and also covered by relevant sections of this manual. When a warning is active a triangle will be displayed in the control panel header area.

Warning	When	Type
Fresh water level low	With pump turned on and fresh water level low (less than 25% full). Only available when an on-board tank is fitted.	Message on screen and 30 second audible beep.
Leisure battery voltage low	With control panel power on and leisure battery selected (as active battery) and the voltage level falls below 10V	Message on screen and 30 second audible beep.
	With control panel power on and leisure battery selected (as active battery) and the voltage level is below 9V	Message on screen and 30 second audible beep. If no action taken after 30 seconds then the system will switch the power off to prevent severe discharge of the battery
	<p>Note: This is an emergency cut off level to protect the battery from severe damage. You should not rely on this cut off level during normal operation, but manage your power consumption to a discharge level of 11.5V or above.</p> <p>This cut off only applies to power drawn from the battery by the leisure equipment that is controlled by the control panel power switch; it will not protect the battery from discharge by permanently connected equipment.</p>	
Leisure battery voltage high	With control panel power on or off and leisure battery is selected (as active battery) and the voltage level rises above 15V.	Message on screen and repeated beeps from the control panel. The power is automatically turned off. The beeping will not stop until the fault is cleared.
Vehicle battery warnings	If the vehicle battery is selected instead of the leisure battery, with the towing vehicle connected, then similar warnings to those described above are applied to the vehicle battery. The vehicle battery low warning level is 10.9V	
Engine running	When the engine is started the system power will be turned off.	Message on screen, Leisure & Vehicle battery symbols indicating both batteries are connected for charging. The charging voltage is also shown on screen.
Mains lead (hook-up cable) still connected / plugged in	When the engine is started and the mains cable is still plugged in and the charger is switched on.	Message on screen and repeated beeps from the control panel. The beeping will not stop until the hook-up lead is removed.

3.18 Common Fault Table

Fault	Possible Cause	Proposed Fix
No 230 volt output from PSU	Connecting lead between the site and Leisure Vehicle not connected	Check and connect lead as per 2.3C
	RCD switched off	Reset RCD as per 2.3D
	RCD not operating correctly	Check supply polarity; if the RCD continues to fail contact your Dealer as there is probably an equipment or wiring fault.
	MCB switched off	Reset MCB by switching OFF (down position) then back ON (up position), if the MCB continues to fail contact your Dealer as there is probably an equipment or wiring fault.
	No or deficient supply from site	Contact site Warden for assistance
	Other fault	Contact your Dealer
Reverse Polarity light is illuminated on PSU	Mains Supply reversed?	The reverse polarity light is designed to illuminate when the Live and Neutral supply has been reversed / crossed over. If the light illuminates there is a problem with the site supply or the cable connecting the supply to your vehicle. The light is designed to work on UK electrical supplies (where the neutral conductor is connected to earth at the sub station). If you are using your vehicle outside the UK this light may illuminate when no fault exists. In these cases consult the site warden for advice.
	Generator being used	'The Reverse Polarity warning light is on when using my Generator'. This is a normal side effect when using some types of generator. Instead of connecting the neutral conductor to earth, some generators centre tap the earth connection making both neutral and live conductors 110V above earth. This 110V difference causes the neon polarity indicator to illuminate. In most cases it is still safe to use the generator, but please consult the generator handbook for further information.

SWIFT COMMAND POWER CONTROL SYSTEM

Control Panel Problems	Control Panel has no display	Check batteries and fuses, turn PSU isolate switch and charger switch on and ensure mains supply is connected. Check control panel connecting lead at PSU and behind Control Panel Contact your Dealer
	12V Power turns off	Battery protect feature has operated to protect the Vehicle battery and or the Leisure battery. See 3.4C Over voltage protection has been activated, the control panel will display a warning. A number of things can cause this but the most common is the solar panel, it is worth checking the regulator is connected correctly and operating within the correct parameters. Engine has been started, all equipment has been disconnected to meet EMC requirements. See 2.6
	Control Panel locked / erratic function	Observe control panel handling instructions. Control panel software may have crashed. Reboot control panel by turning off the PSU isolate switch. Wait 30 seconds then turn the switch back on.

No 12 volt output from PSU	No 230V supply	Check all above
	Charger not switched on	Turn charger switch on, switch will illuminate
	Battery not connected and / or charged	Install charged battery as per 3.4
	Power button on control panel not switched to on	Turn power on at control panel
	Battery flat / Battery fuse blown	Recharge battery, check fuses, check charging voltage is present at battery
	Fuse blown	Check all fuses are intact and the correct value fuse is installed as per fuse table
	Equipment switched off / unplugged	Check equipment is switched on and connected to the 12V supply
	Other fault	Contact your Dealer

Pump not working	Fuse blown	Replace fuse with correct value as per fuse table.
	Pump turned off	Turn pump on by pressing the pump button at the control panel.
	Setting incorrect	Both the internal and external pump feeds are controlled from the control panel. To alter the setting of the pump switch see section 3.8. Ensure the setting matches your desired requirement.
Fault	Possible Cause	Proposed Fix
Lights not working	Fuse/s blown	Replace fuse with correct value as per fuse table.
	Lights turned off	Turn Lights on by pressing the lights button, use dimmer at the control panel.
Bluetooth Communications not working	Bluetooth not paired	Using System Settings menu, select Bluetooth Pair option
	Bluetooth not active on Device	Ensure that the handheld device has Bluetooth switched on and that the device supports the Bluetooth 4 standard (BLE)
	Bluetooth out of range	Ensure the handheld device is within 7M of the middle of the caravan/motorhome switch see section 3.8. Ensure the setting matches your desired requirement.
	Bluetooth connection issue	See App user guide for further details
Remote Communications not working	Account details not entered on App	Enter details in Account page of App settings menu
	Account not registered at time of vehicle delivery	Check with supplying dealer or Sargent Electrical that an account has been registered.

SWIFT COMMAND POWER CONTROL SYSTEM

3.19 Contact details

Sargent Electrical Services Limited provide a technical help line during office hours. Please contact 01482 678981 if you require technical help. For out of hour support please refer to the tech support section of the Sargent web site www.sargentltd.co.uk.

4 Remote Access & Control

4.1 Swift Command App

The Swift Command app can be down loaded from the Apple App Store, the Android Play store or the Windows store (when available).

A separate Swift Command User Guide is available which covers the operation of the app. The app will update as features are continuously developed or added.

Before you can use the App with your caravan you will need to create an account and sign up to the free communication service. This is a simple process and will be explained further by your dealer at the vehicle handover. Additional information is available at www.swiftcommand.co.uk

4.2 Swift Command Web usage & Description

In addition to the mobile App, you can also use the same account and login details to access the Swift Command web site.

Here you can update and amend your details, look at location information and history, review system information and historical data as well as changing some system options and settings.

Additional information is available at www.swiftcommand.co.uk

4.3 Swift Command SIM Coverage & Usage information

The EC600 system, when delivered for mainly UK use, contains Mobile SIM with 36 month contract, which commences upon activation at the Dealership when a customer is assigned to the caravan. Below is a list of the countries covered by the SIM under a fair usage policy, a complete list is available at request.

Austria, Belgium, Bulgaria, Cyprus, Czech Republic, Denmark, Estonia, Finland, France, Germany, Greece, Hungary, Iceland, Ireland, Italy, Latvia, Liechtenstein, Lithuania, Luxembourg, Netherlands, Malta, Norway, Poland, Portugal, Romania, Slovakia, Slovenia, Spain, Sweden, United Kingdom.

For continued use outside of the countries listed above, a change of SIM card should be arranged by your supplying dealer.

4.4 Replacement parts

The Control panel contains a small lithium battery to maintain the clock when no other energy supplies are available this will last in excess of 5 years under normal conditions. The battery is a CR2032 3.0V

The EC630 Communication module contains a special backup battery pack which should last in excess of 3 years under normal conditions. The pack part number is 16308 available from Sargent.

4.5 Updates

From time to time there may be updates to the system software; these updates will be done at service intervals by your dealership.

5 Technical Data & Approvals

5.1 Equipment – EC601, EC602, EC651, EC620, EC630 & PX300 Control Equipment

Outline Specification		
INPUT 230V	230 Volts / 0 to 16 Amps	+ / - 10%
OUTPUT 230V	RCD protected, 2 x MCB outputs of 10A & 1 x MCB output of 16A Separate switched channels for heating system and charger	
INPUT 12V	2 x 20A battery inputs via 2 x 4 way connectors	
SOLAR INPUT	1 X Dedicated solar panel input (20 to 150W panel) via a 2 way connector	
OUTPUT 12V	25A total output via multiple switched channels protected by 13 fused outputs	
Integrated CHARGER	Input 220-240 Volts AC +/- 10%, Frequency 50 Hz +/- 6%, Current 3A max. DC Output 13.6 to 14.4 Volts nominal, Current 25 Amps max (300 Watts).	
Signal INPUT	4 x Fresh water level, 4 x Waste water level, 1 x Engine running, plus multiple vehicle connections, sensor inputs for temperature & humidity	Fresh water negative sensed Waste water negative sensed
Data IN / OUT	CANBUS Data communication and power to Control Panel via 6 way connector CI-Bus Data communication to CI-Bus enabled devices via RJ11/12 connector	
IP rating	IP31	
Operating temperature	Ambient 0 to 35° Celsius Charger case temperature with full load 65° C Max	Automatic shutdown and restart if overheated / overloaded
Dimensions		
EC601 & EC651 PSU	Overall size (HxWxD) 180 x 305 x 135mm Clearances 75mm above, 50mm left & right	Weight 3.8 Kg
EC620 Control Panel	Overall size (HxWxD) 93 x 180 x 32mm Cut-out size (HxW) 82 x 165mm	Fixing centres 166mm X 26MM Weight 150 g
EC630 Comms Module	Overall size (HxWxD) 55 x 116 x 85mm	Weight 550g
EC640 Sensor	Overall size (HxWxD) 60 x 27 x 14mm	Weight 80g

TECHNICAL DATA

5.2 Approvals

System: BSEN 1648-1, BSEN1648-2
compliant, BS7671: 2008 compliant

Residual Current Device: RCD 40A 30mA
trip to BS EN 61008

Miniature Circuit Breakers: MCB's type C
6000A breaking capacity to BSEN 60898

**Electro Magnetic Compatibility
(EMC)** directive 2004/108/EC Certificate
CE20071224-1

Integrated Charger: BS EN 60335-1/2.29,
2006/95EC, IEC61000-3.2/3:1995, 1.

Low Voltage Directive: 2006/95EC TUV-
014900-A1, EN55022, Class B, EN55024/
Level 2

5.3 Declaration of Conformity

Equipment: Leisure Power Control System

**Model name: EC601, EC602, EC651,
EC620, EC630 & PX300**

I hereby declare that the equipment named
above has been designed to comply with
the relevant sections of the above referenced
approvals. The unit complies with all essential
requirements of the Directives.

Signed	Name	Position	Manufacturer
Date:	I L Sargent	Technical Director	Sargent Electrical Services Ltd Unit 35, Tokenspire Business Park Woodmansey, Beverley East Yorkshire, United Kingdom

Whilst every effort has been made to
ensure the accuracy and completeness of
this document, no guarantee is given against
errors or omissions. This document may be
updated / improved over time therefore please
check with your dealer / supplier for update
information or visit:
www.sargentltd.co.uk

The battery box

The Battery Box is intended to accommodate an auxiliary battery in your caravan. The Battery Box has a CE socket to connect to a 230 V power supply. Inside the Battery Box there is the option to fit several sockets and outlets.

⚠ WARNING:

- Use precaution when mounting the battery, as batteries contain acid liquids which can cause severe injuries and damage when handled incorrectly. Refer to the instructions on the battery.
 - No smoking is allowed in the area of the Battery Box!
 - Please note that the CE socket has a max of 16 amp.
- This product meets the latest version of the EN 1648 part 1 and 2 standard.

Before placing the battery inside the Battery Box, the battery should be placed in the Soft Tray and rested on the ground adjacent to the Battery Box. Carefully connect the electrical wires (the red cable attaches to the + pole and the black cable to the - pole of the battery).

Note: Incorrect connection of the cables will cause a short circuit with potential hazardous consequences.

After mounting the terminals, lift the battery together with the Soft Tray into the middle of the Battery Box compartment. Push the battery to the back of the Battery Box.

The battery is then secured by restraining straps (see figure A).

When attaching the 230 volt cable on the CE socket, the maximum recommended thickness of the cable is 10 mm. When closing the door, the attached cable is to be fed through the slot in the door. The maximum battery size that can be fitted is 225mm high (including terminals) x 175mm deep x 353mm wide. The depth and width dimensions include the rim around the bottom used for securing the battery.

Figure A



Cleaning and maintenance

- Use protective clothing and glasses when handling a leaking battery, and avoid direct contact to the skin, eyes and respiratory organ.
- Should a battery leakage occur, please act according to the instructions supplied by the manufacturer of the battery. Act with caution as caustic substances are present in the battery.
- Always remove the battery and the power cable before carrying out any maintenance of the product.
- Before removing the clamps switch off all electrical and gas appliances.
- Use a soft cloth or sponge and a non-acid/abrasive detergent when cleaning the battery box or soft tray.
- To check if any acid is present in the soft tray or bag, simply press it softly. A strong smell from the soft tray may also indicate spilled acid. Always treat spilled battery acid as hazardous waste. Dispose of spilled battery acid according to the local and national regulations.
- Before the camping season or extensive travelling, check the soft tray or bag for faults and replace if necessary.
- The cleaning of the battery box and soft tray or bag should only be done after all power sources have been switched off, in order to prevent a hazardous situations.

BATTERY INSTALLATION

Battery installation

Under normal circumstances it should not be necessary to remove the battery other than for routine inspection of terminals and 'topping up' if required.

⚠ WARNING: Explosive gases may be present at the battery. Take care to prevent flames and sparks in the vicinity.

Your caravan has been fitted with an in-line fuse between the battery terminal and caravan harness. It is recommended that the fuse rating fitted in this location does not exceed 20 amps.

⚠ WARNING: Switch off all electrical and gas appliances and lamps before connecting or disconnecting the battery. Smoking is prohibited around the battery compartment.

To preserve the life of your leisure battery and charger please observe the following:

1. Do not leave all 12V appliances powered at the same time as this will drain your leisure battery more rapidly.
2. If all 12V appliances must be powered together, ensure the battery is 'in-circuit' and that the battery charger is turned on.
3. For optimum performance use the transformer/charger unit with a leisure battery attached.

Battery

It is recommended that a good quality rechargeable leisure battery is always in circuit when the system is in use.

A deep cycling heavy duty 12V battery should be purchased to provide power for lights and other electrical appliances.

A proprietary brand leisure battery with a minimum of 85 Amp capacity is recommended.

Note: 85 Amp batteries and above should be checked dimensionally before purchasing, to ensure fitment within the battery compartment, as brands vary in size.

It should be remembered that batteries suitable for the electrical demands of a caravan differ in design from those for use with a car, and whilst the system may operate with a car battery it is strongly recommended that only a leisure type battery, maintained in good condition is used. The battery should be kept topped up at all times if required.

⚠ WARNING: Your caravan is fitted with Swift Command Tracker (by Sargent) which monitors battery voltage. If you plan to disconnect or remove your leisure battery for maintenance or external charging, then please contact the monitoring station before you remove or disconnect the battery. If a leisure battery is not fitted, please also contact the Tracker monitoring station before removing the mains hook up. The Swift Command Tracker monitoring station can be contacted on 0345 6027302.

Solar Energy System (when fitted)



Your tourer is fitted with a solar panel and regulator. This solar panel and regulator will provide additional 12v power whenever sunlight is available to the panel, and this will be directed to the leisure battery whether the control panel is ON or OFF, and regardless of the position of the SYSTEM SHUTDOWN button. If a factory fitted alarm system is present, that alarm will in turn be able to use the leisure battery as a power supply. Conditions allowing, the system keeps the leisure battery 'topped up' during storage, and will provide a daily boost to the leisure battery when camping without a mains 230V supply.

Note: If additional solar panels are fitted and linked to the factory fitted panel, the maximum combined wattage must not exceed 150W.

Battery power

As a guide

An 80w panel is capable of supplying up to 4.8 amps, +/- 1.5%.



Regulator

Unlike typical regulators, the factory fitted solar panel regulator has been specially designed to draw no power from the leisure battery when the solar panel is not generating power. This feature is desirable especially in winter months when a normal regulator can gradually discharge the leisure battery.

Regulator operation

The regulator operates automatically, turning on and off as required to charge and maintain the leisure battery. When the solar panel is exposed to a source of sunlight the regulator starts to operate. When the voltage from the panel reaches a usable level, the Panel Output LED will flash indicating that the battery is being charged (see battery charging below). If insufficient power is being generated by the solar panel the regulator will turn off. The regulator checks the solar panel output every 30 seconds and turns on and off as required. On overcast days when the solar panel output is minimal the regulator can still deliver a small charge, and in this mode the LED's are not illuminated to conserve power.

Battery charging

If a leisure battery is fitted and requires charging the Charge Status LED will illuminate. Depending on the state of charge of the battery this LED will illuminate red for bulk charge (14.4V output) or green for float charge (13.6V output). It may take a few hours to several days to charge the battery depending on its state of charge. When the battery is fully charged the regulator will turn off to prevent overcharging of the battery. If the mains charger is turned on to charge the leisure battery this can also cause the solar panel regulator to turn off.

Power Supply Unit

The PSU does not need to be switched on (shutdown button in) for the solar panel to charge the battery. During caravan storage the PSU should be shutdown (shutdown button out).

Control Panel

When the solar panel is operating the voltage display on the leisure battery will increase if the loads placed on the battery are sufficiently light.

Maintenance and cleaning

The solar panel will require cleaning periodically in order to maintain the performance of the panel, a caravan, car shampoo or simple soap can be used; no abrasive cleaners should be used.

GENERATOR / HABITATION RELAY / EXTERIOR 230V SOCKET

Generator usage

Caution should be used before connecting a generator to your caravan.

⚠ WARNING: Never start or stop the generator while electrical loads are connected and switched on. Start the engine, let it stabilise, then connect the electrical load. To stop engine, disconnect the electrical load and let engine stabilise before switching off.

Whilst some generators use inverter technology, others use a more basic principle to generate the 230v supply. Preference should be to choose a generator which produces a consistent sinusoidal wave form with accurate voltage control.

The reverse polarity warning light may illuminate when using a generator. This is a normal side effect when using some types of generator. Instead of connecting the neutral and live conductors 110v above earth. This 110v difference causes the neon polarity indicator to illuminate.

In most cases it is safe to use a generator, but please consult the generator handbook for further information.

Habitation relay

Habitation relays are fitted to caravans by manufacturers to comply with the following legislation:

1. The Road Vehicles (Construction and Use) Regulations 1986 Regulation 60 - Radio interference suppression
2. European Community Whole Vehicle Type Approval (ECWVTA) framework directive 2007/46/EC and EU Regulation 661/2009 (General Safety) mandates UNECE Regulation 10 (Vehicles with regard to Electromagnetic compatibility)

A habitation relay must be fitted by manufacturers, safe guarding the consumer. The purpose of the relay is to disable non-homologated appliances/components whilst the vehicle is in transit.

Unintentional electromagnetic energy can be created by non-homologated devices within the habitation compartment, which could cause a malfunction of the caravan's electronic systems/components.

Exterior 230V socket

The recessed electric socket is designed to give you a convenient electrical access point on the outside of the caravan, which is completely protected from the weather, even when in use.

With the caravan stationary and connected to a 220v/240v supply, raise the front cover of the socket and insert the plug of the equipment to be used. Close and latch the cover into place to provide a weatherproof seal.

Please remember that the equipment plugged into the socket may or may not be weatherproof.

Note: Care should be taken when opening the socket cover.

To disconnect equipment, raise socket cover and remove plug, then close and latch the cover into place to ensure a weatherproof seal.

Before moving the caravan from a pitch ensure that all accessory points are disconnected and latched in the closed position to prevent the ingress of water or other foreign matter from causing damage to the point or any of the caravans services.

Any item plugged into this socket will be supplied by the same 10A breaker (MCB) as the other items plugged into sockets within the caravan. Please take into account the total loading placed on the socket circuit and the site supply before switching equipment on. The socket should be used to power a single appliance with an appropriate power consumption rating – **the socket is NOT suitable for use as a supply to power an adjacent caravan or motorhome.**

Internal USB Socket Provision



In addition to the 230v sockets and 12v sockets present on the binnacle at the front of the caravan. Some models have a USB power socket on the front binnacle or on the side of the radio housing. This can be used with a variety of devices such as mobile phones, media players etc, as a power supply for continued running of the device or charging of the internal battery of that device. The socket provides a 5v output in line with the usual USB specification and is powered by the leisure battery and/or charger. The connecting lead between socket and device is not provided, as the format of this lead is device specific.

The fitted USB socket is limited to an output of 1amp – for larger devices such as tablets; use of the adjacent 12v socket with an appropriate adaptor may instead be required.

Please check the instructions supplied with your device for further details.

Note: This USB socket does not provide a means of transferring or storing data, and so is not intended for use with memory sticks or other data storage devices. Depending on specification, the CD/Radio supplied with the caravan.

Truma combination boiler	106
Truma heating system and air flow	107
Truma CP Plus digital timer control	107
Truma combination boiler fault finding	121
Truma combi boiler controls	122
ALDE Compact 3020	126
ALDE Compact 3020 Control Panel operating instructions	134
Dometic absorption refrigerators	145
Thetford mini grill	166
Thetford Caprice cooker	169
Thetford Aspire 2 cooker	172
Dometic Oven	177
Microwave oven	186
Thetford C260 cassette toilet	188
Caravans with external BBQ point	195
Caravans with external shower point	196
Caravans with TV inlet in battery box	197
CD/MP3 tuner	198
Status directional TV and FM radio antenna	198
External entertainment hatch	199
Bedding	199
Doorscreen	201
Exterior door key/operation	201
Windows	202
Roof lights	203
Mini Heki rooflight	203
Midi Heki rooflight	204
Heki-2 roof light (Bessacarr Cameo models)	205
Heki 4 remote control	206
MPK rooflight	207
Care/use of laminate tops, tables, furniture and doors	209
Shower care points	210
Fixing of awnings	210
Paint colour reference	210
Front locker and sunroof	210
Bonded Roof	210
Step on hitch cover	211
Cycle racks	211
Caravan motor mover	211
Omni-vent	212
Rear view camera	213
Service door operation	219

TRUMA COMBI BOILER

The instructions covering fitted equipment to your caravan were correct at the time of going to print. Owners handbooks are updated annually and we take great care to try and ensure their accuracy. However, the Swift Group Limited cannot accept responsibility for any changes that may be made in specification or operating instructions to the equipment described in this section after the time of going to press.

Every care is taken to ensure that the information provided in this handbook is correct and easy to understand.

Separate manufacturers' leaflets on many of the components are also included in the Owner's Pack provided with this caravan and we recommend that you compare the instructions in the handbook with the component manufacturers literature, to ensure the information provided is as accurate as possible.

If you are in any doubt as to how to operate the equipment in your caravan, please contact the component manufacturer's service department on the telephone number shown on their component leaflet. If you remain in any doubt, please contact your supplying dealer.

Notice: In the interest of safety, replacement parts for an appliance shall conform to the appliance manufacturer's specifications and should be fitted by them or their authorised agents.

Truma Combination Boiler

The Truma Combination boiler has been designed to run on gas or electric power and the optimum performance is obtained when used in **dual fuel mode, that is running on gas and electric at the same time.**

Running in dual mode has the following benefits:

- Fastest possible heat up time, the gas burner combines with an electric element to provide energy to heat your hot water and warm your caravan.

- The intelligent heat management system automatically senses when the water and room are nearing the required temperature and then automatically turns off your gas burner and operates solely on electric power, conserving your gas.
- As hot water is used or the room cools the Truma combination heater will continue to operate on electric only until a point where the demands necessitate that additional gas power is required. An example for such a demand could be for instance if the exterior door was left open and the room temperature dropped by 10 degrees in the space of a few minutes, in this case the intelligent heat management system would decide the best way to get the room back to the required temperature would be to use both gas and electric at the same time.

Operating the Truma Combination system on electric or gas only will result in longer heat up times for hot water and the room temperature in comparison to operating on dual fuel.

Operating on electric only may not in all cases maintain a comfortable room temperature especially in colder conditions.

The intelligent heat management system in dual fuel mode allows the Truma Combination boiler to prioritize the electric power source over your gas, this will conserve your gas supply.

Whilst taking energy consumption and the environment into account, consider using the Combi in Summer mode (water heating only) when room or space heating is not required, but may be needed in the near future.

This ensures the appliance is held at the same temperature as the hot water setting chosen, and this can reduce the time taken to provide warm air into the living area, when room or space heating is then selected.

Truma Heating System and Air Flow

The Swift Group undertakes considerable testing of our products in cold chambers to ensure they meet the BS EN 1649 Grade 3 standard and are usable in cold temperatures.

Butterfly outlets

The air ducting outlets on some models equipped with Truma Combi heating systems, are of the butterfly type. These may be opened or closed by moving the flap within the fitting, to adjust the balance of the heating output throughout the caravan. This can help offset differences in blown air output, between outlets close to the heating appliance, and those greater distance away from the heating appliance. This can also help adjust the temperature of the bathroom, relative to the temperature of the main living area and/or bedroom.

When these butterflies are closed in conjunction with a high heating system output, and therefore a high fan speed, a slight whistling sound can occur. In this case, opening the outlet slightly will reduce or remove the noise.

Closing too many outlets when the heating system is producing a high output, can cause the appliance to reach high operating temperatures. This does not in general terms effect the appliance, but can cause the appliance to automatically shut down. This can cause an interruption of the heating of the caravan, however heating will resume when the appliance temperatures have reduced to a lower level.

The output of the appliance, and therefore the output of the blown air outlets, will generally be higher when using Gas or Dual Fuel operation. Electric only operation of the heating is rated at up to 1.8kW, whereas Gas (or Dual Fuel) operation is rated up to 4kW (3.8kW) or 6kW (5.8kW), depending which model or Combi is fitted.

The blown air fittings can also be rotated to adjust the direction of air leaving the outlet, as shown in the photo.

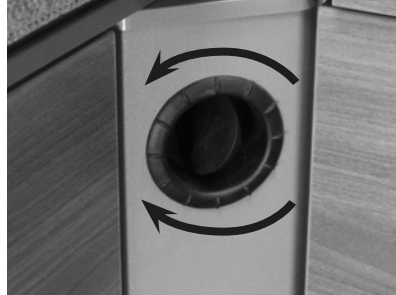

Note: The next instructions detail the operation of the Combi Control Panel - for further details of the Truma Combi appliance, please see the following section.

Truma CP Plus Digital Timer Control (when fitted)

The Truma CP plus control panel is used to control and monitor a Combi CP plus ready heater and/or a Truma air conditioning system. The Truma CP plus serves as an interface for operating connected appliances via Truma App and iNet Box. (Truma aftermarket option)

The following air conditioning systems can be operated with the Truma CP plus:

- Saphir compact
- Saphir comfort RC
- Aventa eco
- Aventa comfort

For further details on connecting and controlling these items, and installation contact your dealer.

Safety instructions

- Operate the Truma CP plus control panel only if it is in technically perfect condition.
- Repairs must be carried out immediately. Only carry out repairs yourself if the solution is described in the troubleshooting guide of this manual.
- Do not carry out any repair work or modifications on the Truma CP plus control panel
- A defective Truma CP plus control panel may

TRUMA CP PLUS DIGITAL TIMER CONTROL

only be repaired by the manufacturer or the manufacturer's service department.

- Never use LP gas appliances when refuelling, in multi-storey car parks, in garages, or on ferries. Switch off the LP gas appliance on the Truma CP plus control panel and make sure that the LP gas appliance definitely cannot be switched on via the Truma App.

Note:

- If the power supply to the system has been interrupted, the time / time switch must be reset.
- If a new or replacement appliance (heater, air conditioning system or iNet Box) is connected to the bus system, the procedure described in "Initial start-up" must be repeated.
- The ZUCB time switch can no longer be used when the Combi CP plus ready heater is connected to the Truma CP plus control panel.
- If an iNET box is connected, the operation of the CP plus controller will differ from these instructions
- The combi heating system can also be controlled using the Swift Command system. See Swift Command section for further details.

Display and control elements

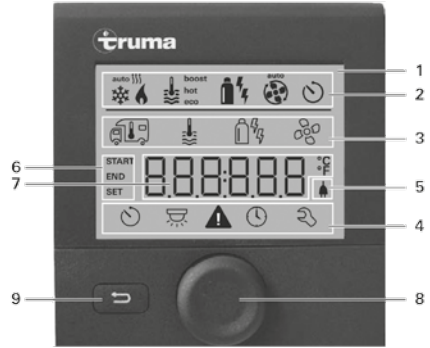

- 1 = Display
- 2 = Status bar
- 3 = Menu bar (upper)
- 4 = Menu bar (lower)
- 5 = 230 V mains supply indicator (power)
- 6 = Time switch display
- 7 = Settings / Values
- 8 = Rotary push button
- 9 = Back button

The menus can be selected in lines (3 + 4) and settings can be made using the rotary push button (8). The display (1) has an illuminated background. The Back button (9) can be used to return from a menu.

Rotary push button

Setpoints and parameters can be selected, modified and saved by tapping on it using the rotary push button (8). Selected menu items flash.

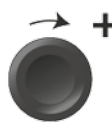

Rotate clockwise

- Menu is run through from left to right.
- Increase values (+).

Rotate anticlockwise



- Menu is run through from right to left.
- Decrease values (-).

Tapping



- Accept (save) a selected value.
- Select a menu item, change to the setting level.

Long Press

- Main switch function ON / OFF.
- Note: If an iNet Box was recognised while searching for an appliance, the function of the rotary push button changes.

Back Button

Pressing the Back button (9) returns you from a menu and discards settings. This means that the previous values are retained.

Initial Set-Up

In order to perform the initial start-up, the following steps are required:

- Switch on power supply, 12V direct voltage for CP plus control panel and Combi and 230V mains voltage for air conditioning systems and Combi E.
- Start the search of the appliances under menu item
“Service menu” -> “RESET” -> “PR SET”.

After confirmation, Truma CP plus control panel initialises itself. “INIT ..” appears on the display while this is in progress. This stores in the Truma CP plus control panel the appliances that have been found.

Note: This initial set up will have been undertaken prior to delivery of your caravan.

Start-Up

Start/Stand by screen

After connecting the control panel to the power supply, a start screen is shown after a few seconds.

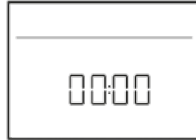

Note:

- The display changes between the time and the set room temperature.
- Special displays on command via Truma App, IR remote control of the air conditioning system (see “Special displays” on page 118).
- After a repair / retrofit, the procedure described under “Initial start-up” must be repeated.

Functions

The functions in the menu bars (3, 4) of the Truma CP plus control panel are selectable in any order. The operating parameters are shown on the status bar (2) and on the displays (5, 6).

Select setting level

- Tap rotary push button.

The display shows the setting level. The first icon flashes.



TRUMA CP PLUS DIGITAL TIMER CONTROL

Switching on and off

Switch on

- Tap rotary push button.
- Previously set values / operating parameters are reactivated after switching on

Switch off

- Press rotary push button for longer than 4 seconds.
- "OFF" appears after another 2 seconds.
- The Truma CP plus control panel deactivation procedure can be delayed by several minutes because of internal heating or air conditioning system after-runs.

Change the room temperature

- Select icon in menu bar (3) with rotary push button.
- Change by tapping in the setting level.
- Depending on the appliance that is connected, select between heating system (HEATER) or air conditioning system (AC) or automatic air conditioning system¹ (AUTO) using the rotary push button.
- Tap rotary push button to confirm selection.
- Select desired temperature with rotary push button.
- Tap the rotary push button to confirm the value.

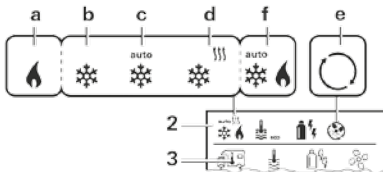

Heater

Settable temperature range 5 - 30°C (1°C steps)

a = heater² – Heater is switched on.

Air conditioning system (AC) (when connected/when AC is fitted)

Settable temperature range 16 – 31°C (1 °C steps)

b = COOL* - Air conditioning system is switched on

c = AUTO - Air conditioning system is set to automatic

d = HOT - Air conditioning system is in heating mode.

e = VENT - Air conditioning system is in air circulation mode

Notes: Quick temperature change using rotary push button possible (in Stand-by screen).

¹Automatic air conditioning system (AUTO) only if "ACC" has been activated in the service menu (see "Service menu" on page 116). This is deactivated at the factory.

² Symbol flashes until the desired room temperature is reached

Automatic air-conditioning system (AUTO)

Settable temperature range 18 – 25°C (1°C steps)

Automatic switch over between heater and air conditioning system for an approximately constant temperature on the inside.

f = AUTO - Automatic air-conditioning system is activated

Requirements for operation with automatic air-conditioning system:

- The heater and air conditioning system must be connected.
- Automatic air-conditioning system "ACC" must be activated in the service menu (see "Service menu" on page 116).

Change the hot water level

Select icon in menu bar (3) with rotary push button.

- Change by tapping in the setting level.
- Select desired level with rotary push button.
- Tap the rotary push button to confirm the value.

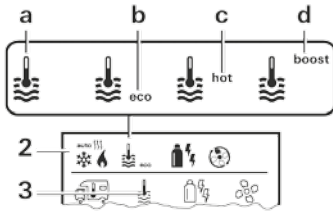

- = **OFF** - Hot water generator is switched off.

a = Boiler¹ - Hot water generator is switched on.

b = Eco² - Hot water temperature 40°C

c = Hot - Hot water temperature 60°C

d = Boost¹ - Targeted, rapid heating of boiler contents (Boiler priority) for a maximum time window of 40 minutes. Then the water temperature is kept at the higher level for two post-heating cycles (about 62 °C). After reaching the water temperature, heating of the room continues.

Notes:

¹ This symbol flashes until the required water temperature has been reached.

² A hot water temperature can only be maintained with combined room and water heating for a limited time at 40 °C.

Select energy source

- Select icon in menu bar (3) with rotary push button.
- Change by tapping in the setting level.
- Select desired energy source with rotary push button.
- Tap the rotary push button to confirm the value.

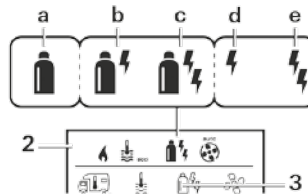

Symbol	Operating mode	Power type
a	Gas	Gas
b	MIX 1	Gas + Electro
c	MIX 2	Gas + Electro
d	EL 1	Electro
e	EL 2	Electro

As soon as the heater is switched on (room temperature, hot water level active), the status line shows the energy type selected in the previous heating procedure. The factory setting is gas / diesel.

TRUMA CP PLUS DIGITAL TIMER CONTROL

Special fixtures in the mixed mode

- Interruption of the mains voltage 230V:

The heating system switches automatically into gas mode. As soon as the 230V power supply has been restored, the heating system automatically switches back to mixed mode.
- Fault in combustion procedure (e.g. lack of fuel).

The heating system switches automatically into electrical mode. For the heater to operate in mixed mode again, the cause of the fault must be remedied and acknowledged on the Truma CP plus control panel. See "Fault" on page 120.

The heater automatically switches to the gas mode. As soon as the 230 V power supply is reconnected, the heater automatically switches back to the mixed mode.

Special features in electric mode

Combi Gas

- If the 230 V power supply is interrupted and the 12 V supply is switched on, a fault code is shown on the display.
- When the 230 V power supply has been restored, the heater is automatically started with the existing settings. The fault code goes off.

Select fan level

With connected heating / air conditioning system

- Select icon in menu bar (3) with rotary push button.
- Change by tapping in the setting level.
- Select desired fan level with rotary push button.
- Tap the rotary push button to confirm the value.

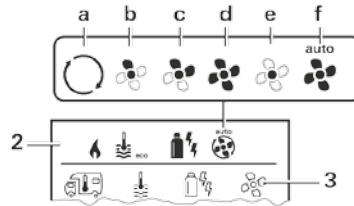

Heater (HEATER)

Icon	Operating mode	Description
-	OFF	Fan is switched off (only selectable if no appliance is in operation).
a	VENT ¹	Circulated air, when no appliance is in operation and the hot water generator is switched off. 10 speed settings available.
b	ECO	Low fan level
c	HIGH ²	High fan level
d	BOOST	Rapid room heating. Available if the difference between the selected and the actual room temperature is >10 °C

Note:

- ¹ Can lead to additional motor wear depending on frequency of use.
- ² Fan level "HIGH" results in higher power consumption, higher noise level and increased motor wear.

As soon as the heater is switched on (room temperature, hot water level selected) the status bar (2) displays the fan level that was selected during the previous heating procedure. The factory setting is "ECO".

Icon	Operating mode	Description
-	OFF	Fan is switched off (only selectable if no appliance is in operation).
a	-	
b	LOW	Low fan level
c	MID	Medium fan level
d	HIGH	High fan level
e	NIGHT	Ultra-quiet fan operation
f	AUTO	Automatic fan level selection. Cannot be changed in AUTO mode.

Automatic air-conditioning system (AUTO), When connected/When AC is fitted

Not possible to select the fan level with the automatic air conditioning system.

- The fan level of the air conditioning system is determined automatically.
- Only "ECO" is available for heaters.

Set time switch

⚠ WARNING:

Danger of toxic exhaust fumes.

The activated time switch switches on the heater even when the vehicle is parked. The heater's exhaust can be toxic in closed spaces (e.g. garages, workshops). If the vehicle is parked in closed rooms:

- Shut off the fuel supply (gas or diesel) to the heater.
- Deactivate the time switch of the Truma CP plus control panel (OFF).
- Switch off the heater on the Truma CP plus control panel.

Note:

- When air conditioning systems are being operated, the time switch of the Truma CP plus control panel must only be used to clearly define the start and end time for a required period of time.
- If the time switch has been activated (ON), the deactivate time switch menu is displayed first (OFF).

- Select icon in menu bar (4) with rotary push button.
- Change by tapping in the setting level.

TRUMA CP PLUS DIGITAL TIMER CONTROL

Enter start time

- Set the hours then the minutes with the rotary push button.

24hour mode

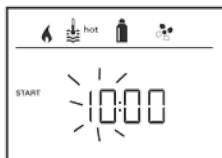

12hour mode



A = a. m.
P = p. m.

Entering the end time

- Set the hours then the minutes with the rotary push button.

24hour mode

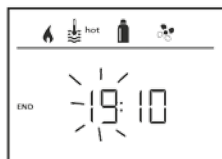

12hour mode

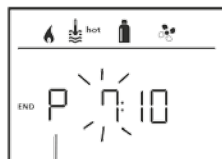

A = a. m.
P = p. m.

Note: If the start/end point was exceeded during entry, the operating parameters are not taken into consideration until the next start/end point has been reached. Until then, the operating parameters that have been set outside the time switch remain valid.

Set the room temperature

- Select the heater, air conditioning system or AUTO using the rotary push button, depending on the appliance that is connected.
- Tap rotary push button to confirm selection.
- Select required room temperature with rotary push button.
- Tap the rotary push button to confirm the value.



Set the hot water level

- Select required hot water level with rotary push button.
- Tap the rotary push button to confirm the value.



Select energy source

- Select required energy source with rotary push button.
- Tap the rotary push button to confirm the value.



Note: The select energy type menu is displayed if a heating system with electric heating elements is connected.

Select fan level

- Select desired fan level with rotary push button.
- Tap the rotary push button to confirm the value.



Note: The Select fan level menu is only available if the heater / hot water level has been set. Not available with automatic air conditioning system AUTO.

Activate the timer (ON)

- Activate time switch with rotary push button (ON).
- Tap the rotary push button to confirm the value.



Note:

- The time switch remains active until it is deactivated (OFF), even for several days.
- If the time switch is programmed and active, the time switch icon flashes.

Deactivate the timer (OFF)

- Change by tapping in the setting level.
- Deactivate time switch with rotary push button (OFF).
- Tap the rotary push button to confirm the value.



Switch lighting on/off

Available when air conditioning system is connected and only with Aventa comfort or Aventa eco air conditioners.

- Select icon in menu bar (4) with rotary push button.
- Change by tapping in the setting level.
- Select required function with rotary push button.

1 – 5 - Switch lighting on.
Brightness selectable in 5 levels.

OFF - Switch lighting off.

- Tap the rotary push button to confirm the value.

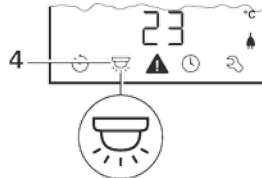

TRUMA CP PLUS DIGITAL TIMER CONTROL

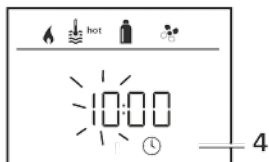
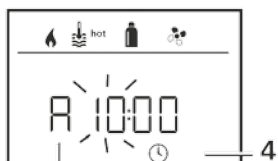
Set time**24hour mode****12hour mode**

A = a. m.

P = p. m.

- With the rotary push button (8), select the "Set time" symbol in the menu bar (4).

The hour display flashes.

- Set the hours with rotary push button (8).
- The minutes display flashes when the rotary push button (8) is tapped again.
- Set the minutes with rotary push button (8).
- Tap the rotary push button (8) to confirm the value.

Service menu**1. Calibrating the room temperature sensor of the heater (OFFSET)**

The room temperature sensor of the heater can be individually adjusted to the sensor's installation situation. The setting can be made in increments of 0.5°C within the range of 0°C to -5°C.



Example:

Set room temperature 23 °C;

OFFSET = -1 °C;

- Setpoint value for heater = 22 °C
Presetting: 0 °C (Celsius).

2. AC SET^{1,2}**(When air conditioner is connected/fitted)**

The sensed room temperature can – during operation of the automatic air conditioning system – be perceived differently during cooling than during heating. "AC SET" is used to set an offset between cooling and heating. The setting can be made in increments of 0.5 °C within the range of 0 °C to +5 °C.



Example:

Set room temperature 23 °C;

AC SET = 2 °C

- Setpoint value for air conditioning system = 25 °C
Presetting: +1°C (Celsius)

Notes:

¹ Only available if the air conditioning system and heater are connected.

² Only available if ACC is set to "ON".

3. ACC¹

(When air conditioner is connected/fitted)

The automatic air conditioning system function AUTO is activated or blocked with "ACC".

- ON**
- The automatic air conditioning system function AUTO is activated. Automatic air conditioning system function AUTO can be selected in the Room temperature menu.
 - "AC SET" appears in the Service menu.
- OFF**
- The automatic air conditioning system function AUTO is blocked.



Presetting: OFF

Note:

The function of the Truma automatic air conditioning system depends on proper installation. Your Truma dealer/ partner would be pleased to advise you whether your vehicle is suitable.

Requirements for the automatic air conditioning system functioning as expected:

1. The air conditioning system and heater cover the entire area of the vehicle that is supposed to be automatically air conditioned.
2. The room temperature sensor of the heater is the lead sensor of the automatic air conditioning system and must therefore be in a suitable location, i.e.
 - in the area in which the required room temperature should be reached.
 - if possible not influenced by the outside temperature and sunlight.
 - not near to warm air ducts, cold air ducts or other sources of heat.
 - warm or cold air from the air outlets must not flow against the room temperature sensor. particular attention must be paid

to this when adjusting the air throttles on Aventa air conditioning systems.

- with good circulation and not on the vehicle ceiling.

Truma dealers / Truma partners are trained in correctly installing the automatic air conditioning system. You can find Truma partners at www.truma.com.

4. °C / °F temperature display

Select the temperature display °C (Celsius) or °F (Fahrenheit).

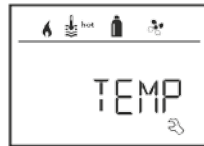

Presetting: °C (Celsius).

5. Changing the background lighting

Change the background lighting of the Truma CP plus control panel in 10 levels.



6. 12 h / 24 h mode

Display time in 12 h (a. m., p. m.) / 24 h mode.



Presetting: 24 h mode.

TRUMA CP PLUS DIGITAL TIMER CONTROL

7. Change language

Select the desired language (German, English, French, Italian).



Presetting: English

8. Showing the version number

Display version number of heater, air conditioning system,

Truma CP plus control panel or iNetBox.



Example:

H 1.20.01 -> H = appliance; 1.20.01 = version number

Appliance

- C = Truma CP plus control panel
- C = Truma CP plus control panel
- SMART Command
- A = Air conditioning system
- H = Heater
- T = Truma iNet Box

9. Presetting (RESET)

The reset function resets the Truma CP plus control panel back to the factory setting. All settings will be deleted. Newly connected appliances are recognised and saved in the Truma CP plus control panel.

- Switch on the power supply
12 V direct voltage for CP plus control panel and Combi and 230 V mains voltage for air conditioning systems and Combi E.

Perform Reset

- Select "RESET" with the rotary push button (8).
- Tap on the rotary push button (8)
- "PR SET" appears in the display.
- Tap the rotary push button (8) to confirm.



After confirmation, the Truma CP plus control panel initialises itself.

"INIT.." appears on the display while this is in progress.

Special displays

230V mains voltage available

The icon signals that 230 V mains power supply is available.

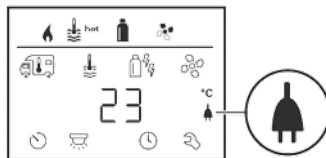

⚠ Warning

This symbol indicates that an operating parameter has reached an undefined state. In this case the appliance concerned continues to operate. As soon as the operating parameter is within the target range again, this symbol goes off again automatically.



Read out code of warning

- Select icon with rotary push button.
- Tap the rotary push button.

The current warning code will be displayed. The cause of the warning can be determined and remedied with the aid of the troubleshooting guide (from page 121).

W = Warning

42 = Fault code

H = Device

H = Heater

A = Air conditioning system



Cause eliminated / return to setting level

- Tap the rotary push button.

Cause not eliminated / return to the setting level

- Press the Back button.

Note: In this case, the warning in the Truma CP plus control panel has not been acknowledged and the warning symbol remains. The affected appliance remains in warning status. Other connected appliances can be operated.

TRUMA CP PLUS DIGITAL TIMER CONTROL

Fault

In the event of a fault, the Truma CP plus control panel immediately jumps to the "Fault" menu level and displays the fault code of the fault. The cause of the fault can be determined and remedied with the aid of the troubleshooting guide (from page 121).



E = Fault

112 = Fault code

H = Device

H = Heater

A = Air conditioning system

Cause eliminated / return to setting level

- Tap the rotary push button.
- The respective appliance is restarted.

Note: This can take several minutes because of internal after-runs of connected appliances.

If the cause has not been remedied, the fault will occur again and the control panel will jump to the "Fault" menu level again.

Cause not eliminated, / return to the setting level

- Press the Back button.

Note: In this case, the fault in the Truma CP plus control panel has not been acknowledged and the warning symbol remains. The appliance remains in fault state. Other connected appliances can be operated.

**Troubleshooting instructions
(Combi Gas heater)**

See table to right

If these measures do not remedy the fault or if fault codes are displayed that you cannot find in the troubleshooting guide, contact Truma Service.

Troubleshooting instructions (Combi Gas heater)

Error code	Cause	Remedy
#17	<ul style="list-style-type: none"> • Summer mode with empty water container 	<ul style="list-style-type: none"> • Switch device off and allow to cool. Fill boiler with water
#18	<ul style="list-style-type: none"> • Warm air outlet blocked 	<ul style="list-style-type: none"> • Check each of the outlet openings
	<ul style="list-style-type: none"> • Circulated air intake blocked 	<ul style="list-style-type: none"> • Remove the blockage from the circulated air intake
#21	<ul style="list-style-type: none"> • Room temperature sensor or cable faulty 	<ul style="list-style-type: none"> • Inspect the room temperature sensor cable, replace if faulty • Check the resistance of the room temperature sensor. 15°C – 16.2 kOhm / 20°C – 12.6 kOhm / 25°C – 10.0 kOhm • Replace the room temperature sensor if faulty
#24	<ul style="list-style-type: none"> • Risk of low voltage. Battery voltage is too low < 10.4 V 	<ul style="list-style-type: none"> • Charge battery
#29	<ul style="list-style-type: none"> • Frost Control heating element has a short circuit 	<ul style="list-style-type: none"> • Disconnect heating element plug from electronic control unit. Replace heating element
#42	<ul style="list-style-type: none"> • Open window above cowl (window switch) 	<ul style="list-style-type: none"> • Close the window
#43	<ul style="list-style-type: none"> • Over-voltage > 16.4V 	<ul style="list-style-type: none"> • Check battery voltage / voltage sources such as the charger
#44	<ul style="list-style-type: none"> • Low voltage. Battery voltage is too low < 10.0 V 	<ul style="list-style-type: none"> • Charge battery. If necessary replace old battery
#45	<ul style="list-style-type: none"> • No 230 V operating voltage 	<ul style="list-style-type: none"> • Restore 230V operating voltage
	<ul style="list-style-type: none"> • Faulty 230V fuse 	<ul style="list-style-type: none"> • Replace 230V fuse
	<ul style="list-style-type: none"> • Overheating protection has triggered 	<ul style="list-style-type: none"> • Please contact Truma Service
#112 #202	<ul style="list-style-type: none"> • Gas cylinder or quick-acting valve in the gas supply line closed. 	<ul style="list-style-type: none"> • Check gas supply and open valves
#121	<ul style="list-style-type: none"> • Gas pressure regulation system iced up 	<ul style="list-style-type: none"> • Use regulator heater (EisEx)
#211	<ul style="list-style-type: none"> • Butane content in the gas cylinder too high 	<ul style="list-style-type: none"> • Use propane. Butane is unsuitable for heating, particularly at temperatures lower than 10°C.
#122 #212	<ul style="list-style-type: none"> • Combustion air infeed or exhaust outlet is sealed 	<ul style="list-style-type: none"> • Inspect openings for obstructions (slush, ice, leaves, etc.) and remove any obstructions
	<ul style="list-style-type: none"> • Gas pressure regulation system faulty 	<ul style="list-style-type: none"> • Inspect / replace gas pressure regulation system
	<ul style="list-style-type: none"> • Electronic system faulty 	<ul style="list-style-type: none"> • Please contact Truma Service
#255	<ul style="list-style-type: none"> • Heater has no 12 V power supply 	<ul style="list-style-type: none"> • Ensure that the 12V power supply is available
	<ul style="list-style-type: none"> • No connection between heater and control panel 	<ul style="list-style-type: none"> • Make connection between heater and control panel
	<ul style="list-style-type: none"> • Control panel cable faulty 	<ul style="list-style-type: none"> • Please contact the Truma Service

TRUMA COMBI BOILER

Truma Combination Heating System Function Description

The liquid gas heater Combi E is a warm-air heater with integrated hot water boiler (10 litre volume). The burner operates fan-supported, which ensures trouble-free function even when on the move. The unit also has heating elements for electrical operation.

In winter operation the heater can be used to heat the room and simultaneously warm water.

3 different options are available for operating the unit.

- gas operation only Propane / Butane for autonomous use
- electrical operation only 230V for stationary use on camp sites
- or gas and electrical operation – mixed operation only possible in winter mode.

Winter operation (Space heating with water heating)

In winter operation, the unit automatically selects the required power setting according to the temperature difference between the temperature set on the control panel and the current room temperature. When the boiler is filled, the water is automatically heated as well. The water temperature depends on the selected operational mode and the heater output. All 3 energy selection options can be used for winter deployment.

With gas operation the unit automatically selects the output level that is required. Depending on the fuse protection at the camping site, power of 900W (3.9 A) or 1800W (7.8 A) can be manually selected for electrical operation.

If more output is required (e.g. heating up or low outside temperatures) gas or mixed operation should be selected so that enough heating power is always available. With mixed operation, 230V electrical operation is preferred if the power requirement is low (e.g. for maintaining the room temperature). The gas burner is not enabled until the power requirement is higher, and is the first to switch off during heat-up operations.

Summer operation (Water heating only)

Gas operation or 230V electrical operation is used for hot water preparation. The water temperature can be set to 40°C or 60°C. With gas operation the water is heated at the lowest burner setting. Once the water temperature is reached, the burner switches off. Depending on the fuse protection at the camping site, power of 900W (3.9A) or 1800W (7.8A) can be manually selected for electrical operation. Mixed operation is not possible. With this setting the unit automatically selects electrical operation.

The gas burner is not enabled.

Repairs may only be carried out by an expert

Guarantee claims, warranty claims and acceptance of liability will be ruled out in the event of the following:

- modifications to the unit (including accessories),
- modifications to the exhaust duct and the cowl,
- failure to use original Truma parts as replacement parts and accessories,
- failure to follow the installation and operating instructions.

It also becomes illegal to use the appliance, and in some countries this even makes it illegal to use the vehicle.

During the initial operation of a brand new appliance (or after it has not been used for some time), a slight amount of fumes and smell may be noticed for a short while. It is a good idea to heat the device up several times in summer operation (60°C) and to make sure that the area is well ventilated. Heat-sensitive objects such as spray cans or flammable liquids may not be stored in the same compartment where the heater is installed because, under certain conditions, this area may be subject to elevated temperatures.

Important operating notes

The integrity and tight fit of the exhaust gas double duct must be checked regularly, particularly at the end of long trips. Also check

the mounting of the appliance and the cowl. Following a blow-back (misfire) always have the exhaust gas system checked by an expert! Always keep the cowl for the exhaust duct and combustion air intake free of contamination (slush, ice, leaves etc.). A number of hot air outlets and the recirculated air intake openings must be free so that the unit does not overheat. The integrated temperature limiter blocks the gas supply when the unit becomes too hot.

Operating Instructions

Always observe the operating instructions and "Important operating notes" prior to starting! The vehicle owner is responsible for the correct operation of the appliance. Before using for the first time, it is essential to flush the entire water supply system through with clean water. If the heater is not being used, always drain the water contents if there is a risk of frost. There shall be no claims under guarantee for damage caused by frost!

Room thermostat

To measure the room temperature, a room temperature sensor is fitted to the furniture. The exact location is determined by the layout of the vehicle.

Taking into operation

Heating is possible without restrictions with gas, electrical and mixed operation, with or without water. Check to make sure the cowl is unobstructed. Be sure to remove any covers that may be present.

For operating on gas turn on gas cylinder and open the shut off valve at the manifold. For operating on electric operate the water heater switch on the power supply unit. See page 78.

Filling the water heater

Switch on power for water pump (main or pump switch) to prime the water system. Open hot water taps in kitchen and bathroom, (set preselecting mixing taps or single-lever fittings to "hot"). Leave the fittings open for as long as it takes for the boiler to displace the air and fill up, and the water to flow without interruption.

If just the cold water system is being operated, without using the water heater, the heater tank also fills up with water. To avoid frost damage,

the boiler must be drained through the drain valve, even if the boiler was not operated.

When connecting to a central water supply (rural or city mains), a pressure reduction valve must always be installed to prevent pressures above 2.8 bar from developing in the water heater.

Draining the water heater

Switch off power to water pump (main or pump switch). Open hot water taps in kitchen and bathroom. In order to check the water that is flowing out, place an appropriate container (capacity 10 litres) beneath the drain valve.

Open the drain valve which is situated next to the boiler by lifting the yellow handle into the vertical position.

Check whether all of the water in the boiler (10 litres) has been drained into the container via the drain valve.

Always drain water content if there is a risk of frost.

There shall be no claims under guarantee for damage caused by frost!

If the appliance is not to be used for a prolonged period, close the quick-acting valve in the gas supply line and turn off the gas cylinder.

Maintenance

Only original Truma parts may be used for maintenance and repair work! Materials in the device which come into contact with water are suitable for use with drinking water (see manufacturer's declaration: [www.truma.com / downloads / manufacturer's declaration](http://www.truma.com/downloads/)).

Bio-film, deposits and limescale must be removed using chemicals to protect the unit from infestation by microorganisms. Only chloride-free products must be used in order to prevent damage to the unit. The effectiveness of the use of chemicals to combat microorganisms in the unit can be increased by heating the water in the boiler to 70°C at regular intervals. The unit must stay switched on for at least 30 minutes and no warm water may be removed. The residual heat in the heat exchanger will heat the water up to 70°C.

TRUMA COMBI BOILER

Fuses 12 V

The fuse is in the electronics beneath the connection cover. Replace the unit's fuse only with an identical fuse.

Device fuse: 10 A – slow – (T 10 A)

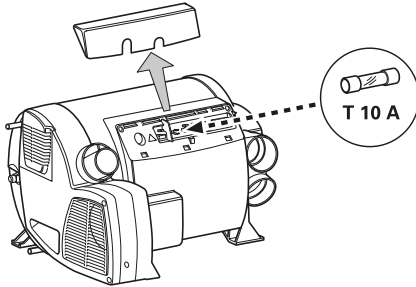

Fuses 230 V

The fuse and the power supply lines must only be replaced by an expert! The unit must be disconnected from the mains (all poles) before opening the electronic housing lid.

The fuse is in the power electronics (16) beneath the electronic housing lid.

This fine fuse must always be replaced with a fuse of the same type: 10A, slow, interrupting capacity "H".

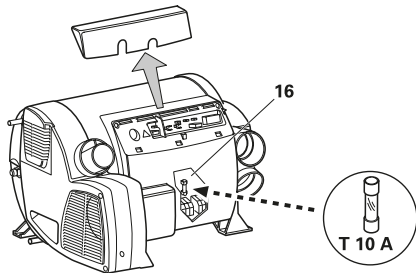

Overheating protection 230V

The 230V heating facility has a mechanical overheating switch. If the 12V power supply is interrupted during operation or during the after-run period, for example, the temperatures within the unit could activate the overheating protection. To reset the overheating protection, allow heater to cool, remove connection cover and press red reset button.

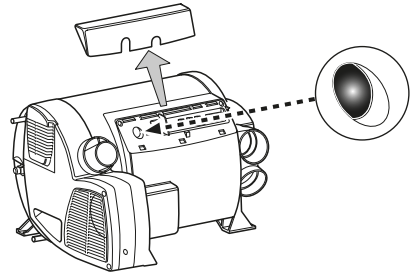

Technical data

Determined in accordance with EN 624 or Truma test conditions

Device category

I₃ B/P in accordance with EN 437

Type of gas

Liquid gas (propane/butane)

Operating pressure

30mbar (see type plate)

Water contents

10 litres

Heating up time from approx 15°C to 60°C

Boiler approx 20 minutes (measure according to EN15033)

Heater + boiler approx 80 min

Water pressure

max 2.8 bar

Rated thermal output

(automatic output levels)

Gas operation

Combi 4 E: 2000 W / 4000 W

Combi 6 E: 2000 W / 4000 W / 6000W

Electrical operation

Combi 4 E / Combi 6 E: 900 W / 1800 W

Mixed operation (gas and electrical)

Combi 4 E: max. 3800 W

Combi 6 E: max. 5800 W

Gas consumption

Combi 4 E: 160-320 g/h

Combi 6 E: 160-480 g/h

Readiness-heat power requirement Combi 4 E

/ Combi 6 E:

Gas operation 5.2 g/h

Air delivery volume

(free-blowing without hot-air pipe)

Combi 4 E:

with 3 hot-air outlets max. 249 m³/h

with 4 hot-air outlets max. 287 m³/h

Combi 6 E:

with 4 hot-air outlets max. 287 m³/h

Current input at 12 V

Heater +boiler

Combi 4 E: Short-term max. 5.6 A
(average power consumption 1.1 A)

Combi 6 E: Short-term max. 5.6 A
(average power consumption 1.3 A)

Heating up of boiler: 0.4 A

Stand-by: 0.001 A

Heating element FrostControl (optional):
maximum 0.4 A

ALDE HEATING OPERATING INSTRUCTIONS

Alde Compact 3020

⚠ WARNING: Alde can accept no liability whatsoever for damage or injury resulting from failure to observe these instructions.

Specific Use

These instructions are approved for the Alde 3020 Compact HE boiler fitted in caravans, motorhomes or buildings in accordance with CE 0402 no. SC0653-13, and have the E5 mark for installation in vehicles in accordance with ECE R122, no. 00 001 and R10, no. 04 166, for use in central heating and hot water systems.

The boiler is not intended for use by persons (including children) with reduced physical, sensory or mental capabilities, or lack of experience and/or knowledge, unless they have been given instruction or are supervised.

The term "specified use" also covers observance of the operating and installation instructions.

The Alde 3020 Compact HE boiler must be installed or repaired by a competent person in accordance with current local regulations.

In the unlikely event that your boiler develops a fault, switch off the boiler and contact Alde, or your dealer or installer.

Operating and installation instructions for the Alde control panel are supplied separately.

The owner is always responsible for maintenance and arranging inspection.

Boiler Design

The boiler's internal heat exchanger consists of three concentric cylinders; the combustion chamber, the central heating cylinder and the hot water cylinder.

The combustion chamber is made from aluminium, and is divided into two halves by a baffle plate, with the burner head located in the top half, and the flue gases venting through the bottom half.

The combustion assembly is fixed to the end of the internal heat exchanger. It consists of the burner, combustion fan, gas valve, air

intake and exhaust ducts, and gas line.

Two electric heating elements are sealed inside the central heating cylinder, one for 1 kW, one for 2 kW.

Gas Heating

When gas heating is set to on, the combustion fan starts to revolve. Once the correct speed is achieved (in rpm), a signal is sent to the PCB for the burner to be lit. The gas valve opens, passing gas, and the ignition module on the PCB generates sparks at the electrode on the burner head.

When the burner ignites, a flame supervision device signals the ignition module to cease sparking. The burner fires until the boiler or room thermostat reach the setpoint.

Should the burner flame cut out unexpectedly, the FSD detects this and attempts to reignite (for about 10 seconds), before shutting down and raising a fault code.

Note: Listen carefully to the ignition sequence of the boiler. You should hear the whirl of the combustion fan, the clunk of the gas valve and the tick-tick of the ignition module.

Electric Heating

When electric heating is set to 1, 2 or 3 kW, relays on the PCB trip, feeding the 230 V supply to the electric heating elements. These are controlled by the same programme as the gas heating.

Domestic Hot Water

The combi-type boiler automatically produces hot water. Heat is emitted from the central heating cylinder into the hot water cylinder. If the hot water cylinder is empty, the air is heated but no damage can result.

Note: In a good summer, for example, lower the desired temperature on the control panel to around 10 °C. The central heating will not circulate (unless the temperature drops to 10 °C), but you will still have hot water.

⚠ WARNING:

- The boiler must not be switched on if there is no heat transfer fluid (HTF) in the system.
- Always drain down the freshwater system if there is risk of frost; in winter, for example. You may continue to use the boiler with no freshwater in the system, as required; no damage can result
- Always replace the HTF in accordance with the antifreeze product's lifespan. If in any doubt, replace the HTF after 2 years.
- Only sterilise the freshwater system with a product suitable for stainless steel.
- Do not place storage in the boiler compartment.
- Do not position awnings, tents or other enclosures around the flue terminal.
- Do not obstruct the flue. Be careful not to flood the flue when washing the vehicle.
- The gas heating must not be used when refuelling the vehicle at the service station or related facility.

Domestic Hot Water

Being a combi-type boiler, the Alde 3020 Compact HE has an integrated, stainless steel hot water cylinder that holds approximately 8.4 litres of freshwater.

The boiler can produce around 12 litres of 40°C warm water per 30 mins (at a cold water temperature of 10 °C). If only the electric heating is used, this capacity is slightly reduced.

The hot water should not be used for drinking or cooking.

Always flush out the hot water cylinder before use, especially when it has stood empty for some time. Any steriliser products should be suitable for use with stainless steel.

Avoid steriliser products containing sodium hyperchlorite, for example, as these will cause severe corrosion damage to the hot water cylinder. Read the product label or contact the product manufacturer for details.

When the hot water cylinder is in continuous use, it should be drained and refilled once a month. This recreates the air cushion in the hot water cylinder that absorbs pressure surges.

Tip! If continuously using the hot water cylinder in a hard water area, fit an inline scale inhibitor to minimise the effects of limescale

Target hot water temperature is greater than 50 °C in normal operation, to prevent the growth of Legionella. Over 50 °C, the hot water will be heated to the maximum achievable temperature at the time. This allows the hot water to achieve disinfection temperatures, and increases warm water performance.

If scalding hot water temperatures are a concern – such as with the young, elderly or infirm – thermostatic mixing valves (TMVs) can be fitted, and may be required by local regulations.



⚠ WARNING: Always drain down and completely empty the hot water cylinder when there is risk of frost, unless the vehicle is explicitly stated to be self-winterising by the vehicle manufacturer.

Failure to drain the hot water cylinder when there is a risk of frost may result in frost damage, and is not covered under warranty.

ALDE HEATING OPERATING INSTRUCTIONS

Draining Freshwater

1. Switch off the water pump.
2. Open all water taps, showers, etc.
3. Open the safety/drain valve by lifting the yellow tab (Fig 1 [M]), or by turning the blue knob (Fig 1 [K]) 90°.
4. The system will drain directly below the vehicle through the clear plastic hose on the safety/drain valve. Check that all water has emptied out (7–10 litres). Leave the valve in the open position until the next time the hot water cylinder is used.

NB: Check that the red breather valve (Fig 1[N]) is allowing air to enter the hot water cylinder, when it is being drained, and that the clear plastic hose is not obstructed.

Open the manual safety/drain valve

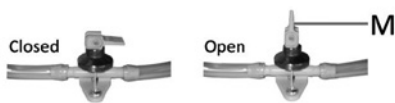

Opening the safety/drain valve

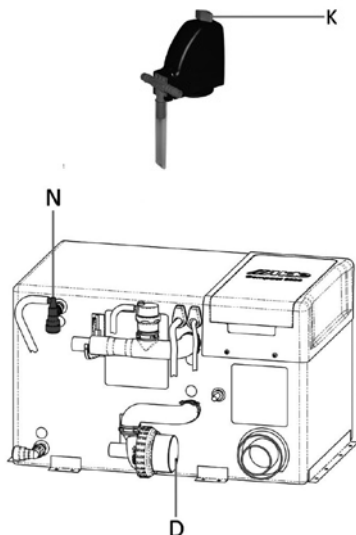

Figure 1

Heat Transfer Fluid

The central heating system is filled with heat transfer fluid (HTF), a solution of 50% ethylene glycol antifreeze and 50% water.

The antifreeze manufacturer will have a maximum water hardness recommendation. Read the product label or contact the product manufacturer for details.

Note: Alde recommends antifreeze meeting VAG G12++ or G13 specification, and deionised water (0 ppm).

50:50 ethylene glycol antifreeze and water will protect against frost down to -35–37 °C. A refractometer and/or hydrometer can be used to measure the strength of the antifreeze solution.

Corrosion protection will vary depending on the lifespan of the antifreeze. Read the product label or contact the product manufacturer for details.

⚠ WARNING: Always replace the HTF in accordance with the antifreeze product's lifespan. If in any doubt, replace the HTF after 2 years.

The corrosion inhibitors found in ethylene glycol antifreeze may not be cross-compatible. When topping up or replacing the HTF, ensure the new antifreeze is compatible with the current antifreeze product. Read the product label or contact the product manufacturer for details.

⚠ WARNING: As a rough guideline, blue and red antifreeze products are not compatible with each other, but VAG G12++ and G13 spec antifreeze (purple/magenta) is compatible with both.

Failure to fill with suitable HTF may result in severe damage to your Alde system, and is not covered under warranty.

Filling

The central heating system is filled with HTF through the expansion tank, either by hand, or using the Alde service pump. Any containers used for handling or storing the HTF should be checked first, and must be visibly clean to avoid introducing contaminants or foreign objects into the system.

Alde recommends using the Alde 1900-811 or 839 twin-motor service pump to fill the system.

To fill the system by hand, unscrew the expansion tank cap (Fig 2 [R]), and lift the circulation pump (Fig 2 [S]) out of the tank (if applicable). Carefully pour the HTF into the tank, and repeat until the fluid level is about 1 cm above the MIN mark when cold.

Figure 2



Draining

A drain is fitted in the central heating system, to allow draining of the HTF. Because the pipes step up and down, some HTF will be left in the system after draining. Contact an Alde certified agent to drain and refill your system.

Central Heating

The boiler is set to an upper limit temperature of 85°C, i.e., the temperature of the heat transfer fluid (HTF) as it circulates around the pipes, radiators, convectors, et al.

To ensure the best performance from hydronic heating, air must be able to circulate freely around the back of the furniture (Fig 3). Air vents, cut into the top and bottom of the furniture must be unobstructed by carpets, cushions, or stowage, etc.

The full length of a convector should be ventilated for best performance.

Note: Use gas and electric heating simultaneously for the best performance. The boiler will only use as much energy as is needed, and is 93% efficient on a SEBDUK based test.

Figure 3

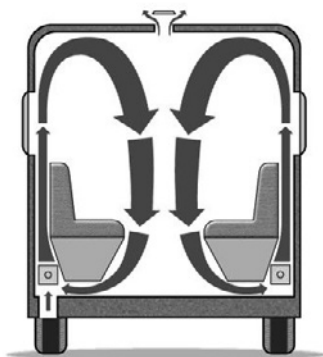

ALDE HEATING OPERATING INSTRUCTIONS

Bleeding Air

The HTF will contain some air. This is unavoidable. Air bubbles can also be introduced when the system is filled.

In a newly-filled central heating system, you will need to bleed air from the bleed points to ensure best performance. There is an automatic air bleed valve on the boiler. There is also an air vent on the expansion tank.

Bleed points are installed at strategic points within the system to allow any trapped air to be bled off

Note: Contact the dealer or installer for details on where the bleed points are in your system, and how to access them.

To bleed the system, set the desired temperature to 30°C and select gas heating on the control panel.

Set the 12 V inline circulation pump on the side of the boiler to speed 5 (Fig 1 [D]), by turning the blue speed dial clockwise, on the face of the pump motor. NB: Speed is not adjustable if using the 12 V circulation pump fitted in the expansion tank.

After 10 mins, set the pump back to its normal running speed (2 for a caravan, 3 for a motorhome).

Now power off the Alde 3020 Compact HE boiler completely, making sure that the circulation pump is not active.

Follow the flow pipe from the boiler, and bleed the system at each bleed point.

If Alde bleed points have been fitted, these are metal bleed screws mounted on black EPDM rubber connectors (Fig 4). Have a cloth in hand. To open, turn the screw anticlockwise between thumb and forefinger. Air will hiss out. When fluid trickles out, close the bleed screw and mop up fluid with the cloth.



Move on to the next bleed point and repeat, until all bleed points have been tended to.

Air Lock

If enough trapped air accumulates at one point, an air lock can result and prevent the circulation of hydronic heating.

A ramp or steep slope can be used to raise one end of the vehicle, causing the trapped air to shift around the system. Repeat the full bleed procedure. A caravan can be slowly and carefully tilted to reproduce this effect.

To clear a stubborn air lock in under 15 minutes, an Alde-certified service agent can use the Alde 1900-811 or 839 twin-motor service pump.

230 V ELECTRIC

The Alde 3020 Compact HE boiler has two 230 V electric heating elements, outputting 1050 W and 2100 W, or 3150 W combined, and drawing 5 A, 9 A, and 14 A respectively (rounded).

230 V breakers, fuses, fused spurs and isolator switches should be rated for 16 A.

Before using electric heating, check the current limit on the electric supply you are hooking up to.

- 6 A limit, only use 1 kW electric heating.
- 10 A limit, use 1–2 kW electric heating.
- 16 A limit, use 1–3 kW electric heating.

NB: If the electric supply has unstable voltage, the amperage will also fluctuate.

LPG

LPG (liquefied petroleum gas) has two main variants, propane and butane gas. The gas heating in your Alde 3020 Compact boiler can use propane or butane gas as fuel. Many LPG fuels contain a mixture of propane, butane and other additives.

BS 5482 Part 1 states, "For butane cylinders, satisfactory service might not be obtained at temperatures of less than 10 °C; the most suitable temperature range is from 13 to 30 °C. For temperatures less than 13 °C, the use of propane should be considered."

For this reason, Alde recommends using propane gas for all year round gas heating.

LPG cylinders contain both gas and liquid forms. When the cylinder is filled, high pressure transforms the gas into liquid. The liquid reverts to gas when the valve on the cylinder is opened.

LPG is a flammable gas. It can be a fire and explosion hazard if stored or used incorrectly. Store cylinders vertically and securely, to prevent them from toppling.

Do not mount your LPG cylinder horizontally or use liquid phase gas cylinders. Liquid-gas explosion may result. Read the product label or contact product manufacturer for details.

LPG is heavier than air. Should a gas leak occur the fitted floor vents allow the gas to escape from the caravan. For this reason always ensure that floor vents are unobstructed.

⚠ WARNING: The boiler compartment contains the gas connection, floor vents and the flue hoses. Do not place stowage in the boiler compartment.

In the event of a gas leak, or if you smell gas:

- Extinguish all naked flames
- Open all doors and windows
- Close all gas valves, including the valve on the cylinder.
- Do not smoke.

- Do not operate any electrical appliances or switches.
- Arrange for immediate inspection of the gas system by a competent person in accordance with current local regulations.

LPG from the cylinder is reduced in pressure by a regulator, and is supplied to the boiler at low pressure (30 mbar). Never use an unregulated high pressure supply.

Where oil and dirt in the gas supply are a concern, gas filters should be fitted to prevent blockage of the boiler gas valve.

Gas heating must not be used whilst driving your vehicle unless a safety shut-off device is fitted to the gas system. Current local regulations must be adhered to.

Flue

The burning of LPG produces CO₂ (carbon dioxide), a non-toxic, asphyxiant gas.

Exhaust flue gas can cause possible burns and poisoning. Avoid inhaling exhaust flue gas.

⚠ WARNING:

Do not position awnings, tents or other enclosures around the flue terminal.

Air supply is essential for clean combustion. The air intake is located in the flue terminal. For best performance, the flue terminal should be well vented. If leaving the gas heating unused for a period, ensure the flue terminal is covered to prevent pest animals nesting in the flue.

⚠ WARNING:

Do not obstruct the flue. Be careful not to flood the flue when washing the vehicle.

⚠ WARNING: Air is sucked into the combustion chamber via the air intake. The gas heating must not be used when refuelling the vehicle at the service station or related facility.

ALDE HEATING OPERATING INSTRUCTIONS

Maintenance

There is no manufacturer's service requirement for the Alde 3020 Compact boiler itself. Current local regulations must be adhered to. The installation of the boiler should be inspected annually for gas safety.

LPG hoses should be regularly checked for signs of damage and should be replaced, at maximum, after 5 years of use.

Bleed air from the system when newly filled, when the vehicle has been standing unused for a period, and before departing on holiday.

The fluid level in the expansion tank should be about 1 cm above the MIN mark when cool. The heat transfer fluid (HTF) should be topped up if below this level, to prevent a break in circulation. Only top up with compatible HTF.

Never leave the system empty of HTF.

⚠ WARNING: Always replace the HTF in accordance with the antifreeze product's lifespan. If in any doubt, replace the HTF after 2 years.

Failure to maintain the condition of HTF may result in frost and/or corrosion damage, and is not covered under warranty.

When the hot water cylinder is in continuous use, it should be drained and refilled once a month. This recreates the air cushion in the hot water cylinder that absorbs pressure surges.

Winter

When camping in the winter, always ensure the flue terminal remains unobstructed by snow and ice. Extensions for roof flue terminals, and condensate spouts for side flue terminals are available from Alde.

Check the strength of the heat transfer fluid (HTF) with a hydrometer and/or refractometer. It should measure 50% ethylene glycol antifreeze, or -35–37 °C.

The central heating can still be used with no freshwater in the system. The air in the hot water cylinder is heated but no damage can result.

⚠ WARNING: Always drain down and completely empty the hot water cylinder when there is risk of frost, unless the vehicle is explicitly stated to be self-winterising by the vehicle manufacturer.

If camping in temperatures below -10 °C, consider carrying spare parts in the event of an emergency. Alde recommends a 12 V circulation pump (with cabling), a PCB, and 4–5 litres of ready to use antifreeze. These spare parts should be kept well insulated and in the warmest part of the vehicle; for example, in the wardrobe, near to the expansion tank pipes.

If storing the vehicle for winter, ensure the flue terminal is covered to prevent pest animals nesting in the flue.

Note: Air the vehicle over winter without wearing out the light duty pump. Use the programmable Alde control panel to automatically heat the vehicle for 24 hours, once a week.

While taking energy consumption and the environment into account, consider switching the Alde appliance ON when room or space heating is not required, but may be needed in the near future. This ensures the appliance is held at the same temperature as the hot water setting chosen, and this can reduce the time taken to warm the living area, when room heating is then selected.

Trouble-Shooting

The Alde control panel will display any error messages. See the Operating and Installation Instructions supplied separately.

The system is completely dead, the control panel is blank

- Check the 20 mm T3.15 Amp glass fuse in the boiler. This is located under the lid of the black plastic service hatch, in a green plastic fuse holder.
- Check the 12 V supply to the boiler, it should be above 12 V.
- Check the 12 V cable is plugged into the boiler. Check the cable is plugged into the Alde control panel.

The boiler will not ignite on gas

- Check the gas cylinder is full. Try a different gas cylinder, ensuring it is propane gas.
- The system may not need to use gas heating, if also using electric heating.
- The fluids in the boiler may already be at operating temperature.

The boiler will not heat on 230 V electric

- Check that any 230 V isolator switches are on (they will often have an LED indicator).
- Check the 230 V supply to the vehicle.
- The fluids in the boiler may already be at operating temperature.

No hot water

- Check that hot water ignore is not activated on the Alde control panel.
- Check that constant pumping is not activated on the Alde control panel.
- Check for other conflicting settings on the Alde control panel.
- Check the freshwater supply and water pump.

No central heating

- Bleed the system of air.
- Check the fluid level in the expansion tank.
- Check that the circulation pump is responding.
- Check that hot water boost is not activated on the Alde control panel.
- Use gas and electric heating.
- Check that vents in the furniture are not obstructed.
- Check the condition of the heat transfer fluid.
- Most vehicles will reach a comfortable temperature within an hour, in non-extreme conditions.

If problems persist, please contact Alde, or your dealer or installer.

WARRANTY

Alde undertakes to rectify any manufacturing defect or early component failure through normal use that occurs within 12 months of the installation date.

If your Alde boiler develops a fault, your first action should be to contact your dealer or installer, as they will be familiar with your installation and vehicle, and how to make a claim under warranty.

Alde International (UK) Ltd Huxley Close Park Farm South Wellingborough Northamptonshire NN8 6AB

Tel. 01933 677765 www.alde.co.uk

ALDE HEATING OPERATING INSTRUCTIONS

Alde 3020 - 113 Colour Touch Operating Instruction

The Alde 3020 Compact HE control panel has two hard buttons and a non-capacitive, colour touchscreen interface. The soft buttons displayed on the screen are operated by touching the screen with your finger.

⚠ WARNING: Please read the Alde 3020 Compact HE operating instructions fully before using the system.

The Alde heating system can also be controlled using Swift Command. See Swift Command instructions for further details.

Starting the System



1. Both the control panel and boiler are off.
2. To start the system, press the Power button on the control panel. The Splash Screen is displayed and green LED is lit. The boiler will now start with the previously saved settings (factory settings by default).

The system will now be drawing variable 0.1–1.5 A of current from the 12 V supply.

Standby Screen

The Standby Screen is displayed after the Splash Screen. This screen contains useful information about the status of your heating system.

NB: If Standby Screen is set to "Dark" in Backlight settings, the Standby Screen will not be displayed, the screen will be dark unless touched.

- A. Clock is enabled. Day of the week and time shown.
- B. Outdoor temperature. [Optional outdoor temperature sensor required.]
- C. Room temperature. Measured at the control panel. [Optional discrete room temperature sensors available.]
- D. Central heating circulation pump is active.
- E. Delayed Start/Cycle is enabled.
- F. Day Mode active.
- G. Gas cylinder status. Full/empty and EisEx mode shown. [Additional accessories required.]
- H. Night Mode active.
- I. 230 V supply. If not displayed, the boiler is not receiving 230 V supply.
- J. Power button. Press to switch system on-off. Lit green LED indicates system is on.
- K. MENU button. Press to access Main Menu from Standby Screen or Settings Menu.

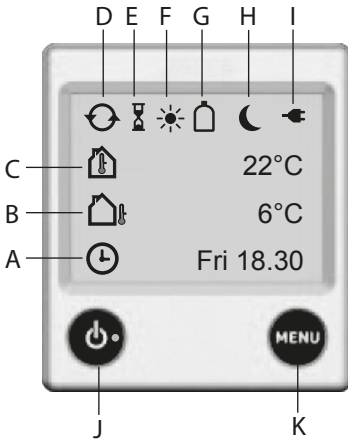

Main Menu

Press MENU button to access the Main Menu from the Standby Screen or Settings Menu. The screen will revert to the Standby Screen after 30 secs if untouched.

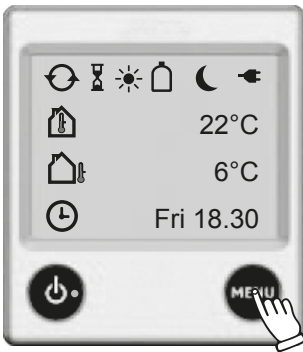

1. Standby Screen. Press MENU button.
 2. Main Menu.
- a. What's Activated Menu. [Not displayed if no activated functions are detected.]
- b. Settings Menu

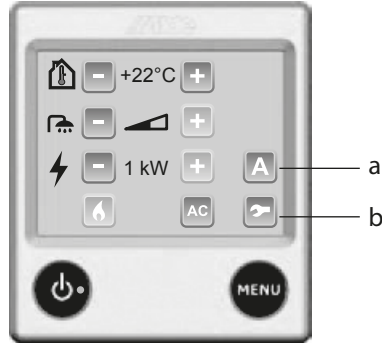

Desired Room Temperature

The desired room temperature can be set from 5 to 30 °C, in 0.5 increments.

TIP: The World Health Organisation recommends a room temperature of 18–24 °C for healthy living.

NB: If Day or Night Mode are active, the temperature cannot be adjusted, the Plus and Minus buttons will be greyed out.



1. The current desired room temperature is displayed.
2. Adjust by pressing Plus or Minus button.

Domestic Hot Water

The Alde boiler stores 8.4 litres of hot water as standard. If the hot water cylinder is empty, the air is heated but no damage can result.

ALDE HEATING OPERATING INSTRUCTIONS

TIP: In a good summer, for example, lower the desired temperature on the control panel to around 10 °C. The central heating will not circulate (unless the temperature drops to 10 °C), but you can still control hot water.

In a good summer, for example, lower the desired temperature on the control panel to around 10 °C. The central heating will not circulate (unless the temperature drops to 10 °C), but you can still control hot water.



1. Hot Water Ignore. Volume bar empty. No attempt is made to heat hot water specifically. This saves energy when the fresh water is drained down.
2. Hot Water Normal. Volume bar half-full. Hot water is heated to greater than 50 °C. NB: If Circulation Pump is set to Continuous, this option will not be available.
3. Hot Water Boost. Volume bar full. Central heating circulation is disabled for 30 mins. Hot water is heated to greater than 65 °C. After 30 mins the system reverts to Hot Water Normal.
4. Adjust by pressing Plus or Minus button.

Electric Heating

Check that 230 V supply is displayed on the Standby Screen. The Alde boiler is hard-wired to use power economically and there are times when it may use no power at all, even if set to 3 kW.

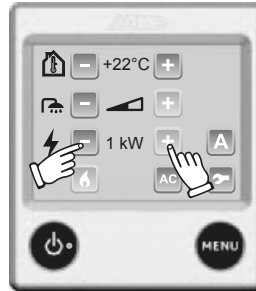

1. Select Off, 1, 2 or 3 kW electric heating. More power equals better performance, but may be restricted by the current (amps) limit on the electric hook-up.

2. Adjust by pressing Plus or Minus button.

Max current draw from 230V supply is 4.5A on 1kW, 9A on 2kW, 14A on 3kW. If the electricity supply has unstable voltage, the amperage will also fluctuate.

Gas Heating

The Alde boiler is hard-wired to use power economically. The gas burner has two stages, shifting dynamically between low or full flame. There are times when it may use no power at all, even if gas heating is selected.

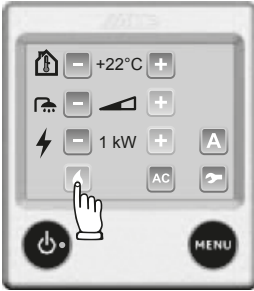

1. Press the Flame button to select gas heating. Green is on, blue is off.

Use both gas and electric heating for best performance.

What's Activated Menu

Press the A button to access the What's Activated Menu. This screen shows any functions that are activated and allows direct access to that function by pressing its button. NB: The A button is not displayed if no functions are activated.



Please note: Not all functions are relevant to a caravan installation.

	Night Mode is enabled, but may or may not be active, depending on the time and day.
	Delayed Start/Cycle is enabled, but may or may not be active, depending on the time and day.
	Alde Smart-Control or daisy-chained, third party control panel is enabled. This feature must be engaged to use the Swift Command control panel or app for control of the heating system.
	Circulation Pump is set to Continuous. NB: This will reduce the hot water supply.
	Day Mode is enabled, but may or may not be active, depending on the time and day.
	Load Monitor is enabled and an amp limit is set.

Settings Menu

Press the Tool Button to access the Settings Menu from the Main Menu. Lower level functions can be accessed by from these screens by pressing the buttons. NB: If a function is not available its button is greyed out.



ALDE HEATING OPERATING INSTRUCTIONS

**Delayed Start/Cycle**
(requires Clock to be set)

Allows you to programme the boiler to start at a specified time and day, weekly. It will provide heating using the last saved settings for 24 hours, before automatically shutting down again. This is recommended for airing the vehicle over winter if stored locally and hooked up to 230 V power. Once Delayed Start/Cycle is enabled, the system should be shut down by pressing the Power button.

**Clock**

The clock must be set for programmable functions to activate at the correct time/day. If 12 V power is lost, the clock will reset.

TIP: The optional Alde 3010-414 battery backup uses two AA batteries and allows the clock memory to be stored even if 12 V power is lost.

**Navigation Arrows**

There are four screens in the Settings Menu. The up/down arrows allow you to navigate between them.

**Night Mode**
(requires Clock to be set)

Allows you to programme the boiler to automatically change and select settings at night. Set a start and stop time for the night-time period. Set a day of the week, or "All" for the same daily programme. You can also define:

- Desired room temperature
- Invert Standby Screen
- Hot water ignore
- Temperature sensor (if discrete room temperature sensors are connected)
- AC Quiet Mode (if Truma Aventa Comfort air-conditioning unit is connected)

**Day Mode**
(requires Clock to be set)

Allows you to programme the boiler to automatically change and select settings during the day. Set a start and stop time for the day-time period. Set a day of the week, or "All" for the same daily programme. You can also define:

- Desired room temperature
- Hot water ignore

**Temperature Offset**

Recalibrate the room temperature displayed by the control panel in 0.5 °C increments. If an outdoor temperature sensor is connected, this can also be recalibrated.

**Return**

Return to the previous menu.

**Prioritise**

Select whether to prioritise gas heating or electric heating, when using both. Less demand will be placed on the non-prioritised fuel.

TIP: If you're hooked up to a site with a flat rate 230 V supply, but still want the extra performance from gas heating, prioritise electric heating to save money on gas.

**Button Sound**

Bleep when a button is pressed.

**Backlight**

The brightness of the Standby Screen can be adjusted from 1–3. The display mode of the Standby Screen can also be set.

Dark. The Standby Screen is deactivated, the control panel may appear dormant except for the power LED. Pressing the screen will activate the Standby Screen for 30 secs. Suited for use in dark/night-time conditions.

Bright. The Standby Screen shows dark characters on a light background. Suited for use in bright/day-time conditions.

Invert. The Standby Screen shows light characters on a dark background. Suited for low light conditions.



Antimicrobial (requires Clock to be set)

Hot Water Boost will automatically activate at 02:00 every morning. This further reduces the risk of Legionella bacteria.



Circulation Pump

Select which circulation pump to use for the central heating, depending on what pumps are installed.

(Your caravan is fitted with Pump Manual 12V)



Pump Manual 12 V. For the 12 V inline circulation pump with manual 5-speed dial.



Pump Remote 12 V. For the remote-controlled 12 V inline circulation pump. Pump speed can also be set. Speed 2 is recommended. Speed 4–5 should only be used prior to bleeding the system of air.



Optional Pump 12 V. For the optional 12 V circulation pump in the expansion tank.



Pump 230 V. For the 230 V inline circulation pump.

Auto. Automatically selects the 230 V pump when a 230 V supply is detected, or the optional 12 V pump when only 12 V supply is available.

Pump mode can also be set.

Cont. The pump is continuously active. This will reduce the hot water supply. For testing the circulation pump in the summer, if room temperature exceeds 30 °C.

Thermo. The pump is controlled by the room thermostat.



External Switch

Allows you to use a third party, external switch to start up and shutdown the boiler. When the

external switch starts the boiler, it will provide heating using the last saved settings. Once External Switch is enabled, the system should be shut down by pressing the Power button. The external switch then takes control of the boiler.

Ext. When a circuit is made at X18 on the boiler, the boiler is started. When the circuit is broken, the boiler shuts down. For use with a third party rocker or toggle switch, or compatible telematics systems. NB: The Alde 3010-219 adaptor lead is available for connecting an external switch.

230V. When 230 V is detected, the boiler is started. When 230 V supply is lost, the boiler shuts down. No additional accessories required.

Off. External Switch is disabled.

TIP: Hiring out a vehicle? Your customers can operate the central heating/hot water with a convenient wall switch, whilst the control panel is fitted in a locked maintenance cupboard with a discrete room temperature sensor. On-off, no hassles.



Language

Select English, French or German language. NB: The Service Menu is English language only.



Load Monitor

If an Alde 3010-246 load monitor is installed, this allows you to set an amp limit from 5–17 A for the vehicle's 230 V power. If the current drawn by the vehicle exceeds the amp limit, the boiler will automatically reduce power.

This helps avoid tripping the circuit breakers on the electric hook up. The load monitor can be disabled by selecting "Off".

ALDE HEATING OPERATING INSTRUCTIONS

Settings Menu

Press the Tool Button to access the Settings Menu from the Main Menu. Lower level functions can be accessed by from these screens by pressing the buttons. NB: If a function is not available its button is greyed out.



Error Log

Press the Warning button to access the Error Log from the Service Menu. The most recent 20 error messages are displayed. To verify an error message, remove the system from the 12 V and 230 V supply. Wait 10 secs before restoring 12 V and 230 V power to the system.



Reset

Press Reset to restore factory default settings, and the Error Log will be cleared. NB: The Main Menu will be set to 22 °C, Hot Water Normal, 1 kW electric heating and gas heating.

Note: Using Reset to restore factory default settings does not clear Installed Accessories.

Shutting down the system

To save energy, the control panel only updates the boiler after the last adjustment is made. Wait 10 secs before shutting down the system to ensure the boiler is updated.

1. Press the Power button again. The screen goes dark, the green LED is unlit. The system is off.

Installed Accessories Menu

After fitting an accessory to the Alde 3020 Compact HE, it must be installed in the control panel software by ticking the box for that accessory in the Installed Accessories Menu, unless otherwise noted. Press the Installed Accessories button to access the menu from the Settings Menu.



The following options are shown as standard. Tick the box to install:

- Alde Smart Control, or third party control panel (connected to JP3 on Alde control panel). This includes the Swift Command system (E600) fitted to your caravan.
- Optional 12 V circulation pump in expansion tank (connected at X4 on boiler)
- Load Monitor (connected to X5 on boiler)
- 12 V inline circulation pump with manual 5-speed dial

ALDE HEATING OPERATING INSTRUCTIONS

- Remote controlled 12 V inline circulation pump
- 230 V inline circulation pump

Setup

How you set up your system will depend on what accessories are installed and your user preferences. To get you started, here's how to setup some of the more common features.

Restore default factory settings

Before using the system for the first time, restore default factory settings. Your control panel may have been tested by the dealer or installer, and some settings may have been changed unintentionally.

1. Press Tool button to access the Settings Menu (bottom right in Main Menu).
2. Press down arrow, until Reset button is displayed.
3. Press the Reset button to proceed.

Setup Standby Screen for bedtime

The backlight on the Standby Screen can be disturbing if the control panel is visible from your bed. It can be inverted for white text on black background.

1. Press Tool button to access the Settings Menu (bottom right in Main Menu).
2. Press down arrow, until Backlight button is displayed.
3. Press Backlight button, select Invert to proceed.

Setup Antimicrobial function

To actively kill Legionella, setup the Antimicrobial function. At 2:00 every night, the hot water will be heated to over 65 °C for 30 mins. This further reduces the risk of Legionella.

1. Press Tool button to access the Settings Menu (bottom right in Main Menu).
2. Press Clock button, set the time and day. Press Return.
3. Press down arrow, until Antimicrobial button is displayed.
4. Press Antimicrobial button to proceed.

Troubleshooting

Any error messages will be displayed on the Standby Screen. Error messages can be cleared by removing 12 V supply to the boiler for 10 secs.

The system is completely dead, the control panel is blank

- Check the 20 mm T3.15 Amp glass fuse in the boiler. This is located under the lid of the black plastic service hatch, in a green plastic fuse holder.
- Check the 12 V supply to the boiler, it should be above 12 V.
- Check the 12 V cable is plugged into the boiler. Check the cable is plugged into the Alde control panel.

The boiler will not ignite on gas, but no error message

- The system may not need to use gas heating if also using electric heating.
- The fluids in the boiler may already be at operating temperature.

The boiler will not heat on 230 V electric

- Check the circuit breaker and any 230 V fuses.
- Check that any 230 V isolator switches are on (they will often have an LED indicator and 230V fuse).
- Check the 230 V supply to the vehicle.
- The fluids in the boiler may already be at operating temperature.

No hot water

- Check that Hot Water Ignore is not activated on the Alde control panel.
- Check that Continuous pumping is not activated on the Alde control panel.
- Check for other conflicting settings on the Alde control panel.
- Check the fresh water supply and water pump.

No central heating

- Bleed the system of air.
- Check the fluid level in the expansion tank.
- Check that the circulation pump is responding.
- Check that hot water boost is not activated on the Alde control panel.
- If electric heating is not being used, set it to "Off" on the Alde control panel.
- Use gas and electric heating for best performance.
- Check that vents in the furniture are not obstructed.
- Check the condition of the heat transfer fluid.
- Most vehicles will reach a comfortable temperature within 40 mins, in non-extreme conditions.

Circulation pump active even though system is off

- 12 V supply to the boiler dropped to 7 V momentarily. Check 12 V supply for stability.

"Panel failure 1" & "Panel failure 2"

- Moisture is trapped in the control panel.
- Remove the Alde control panel from the vehicle and air in a warm, dry place overnight.

"Gas failure"

- Out of gas or gas is not igniting.
- Check the gas cylinder is full. Try a different gas cylinder, ensuring it is propane gas.
- Check the gas regulator and any isolation valves are open and not frozen.

"Overheat red fail" or "Overheat blue fail"

- Bleed the system of air.
- Check the fluid level in the expansion tank. It should be 1 cm above Min mark when cool.
- Check the correct circulation pump is installed, selected and responding.
- 12 V supply to the boiler dropped to 7 V momentarily. Check 12 V supply for stability.
- Wait 15 mins for the fluid to cool down.

ALDE HEATING OPERATING INSTRUCTIONS

“Overheat PCB”

- Failsafe in boiler has triggered.
- Check the fluid level in the expansion tank. It should be 1 cm above the Min mark when cool.
- Check the boiler compartment is ventilated, and that the vents are unobstructed. Do not place storage in the boiler compartment.

“Fan failure”

- Combustion fan speed too low. Bearing may be stiff after a period of disuse.
- Automatically clears after 5 mins. Please try again.

“Connection failure”

- Loose connection between Alde control panel and boiler.
- Unplug cable at the control panel and boiler, then carefully plug back in.
- Check there is slack on the cable at the control panel, but not excessive weight from free-hanging/unmanaged cable.

“Window open”

- Optional window sensor has triggered, gas heating is suspended. Automatically clears and gas heating resumes when window is closed.

“3rd Party Panel C. Fail”

- Break in comms between Alde control panel and third party control panel.
- Check the cable between the Alde control panel and third party control panel.
- Third party control panel is installed in software but not fitted.
- Untick “Third Party Panel” in Installed Accessories Menu.

“Low battery”

- 12 V supply to boiler has dropped below 10.5 V, possibly causing system brownout.
- Automatically clears when 12 V supply reaches 11 V.

“No match Heater/Panel”

- Control panel is incompatible with boiler PCB.
- Check control panel part number. Control panel 3020-013 is for 3020 A-series boiler, 3020-113 is for 3020 HE-series boiler.

If problems persist, please contact Alde, or your dealer or installer.

For our frequently asked questions, or download all instruction manuals, please visit our web site at: www.alde.co.uk

Dometic absorption refrigerator

Before you start using the refrigerator, please read the operating instructions carefully.

These instructions provide you with the necessary guidance for the proper use of your refrigerator. Observe in particular the safety instructions. Observation of the instructions and handling recommendations is important for dealing with the refrigerator safely and for protecting you from injury and the refrigerator from damage. You must understand what you have read before you carry out a task.

Keep these instructions in a safe place close to the refrigerator so they may be referred to at any time.

Copyright protection

The information, texts and illustrations in these instructions are copyright protected and are subject to industrial property rights.

No part of these instructions may be reproduced, copied or utilised in any other way without written authorisation by Dometic GmbH, Siegen.

Warranty

Warranty arrangements are in accordance with EC Directive 44/1999/CE and the normal conditions applicable for the country concerned.

For warranty or other maintenance, please contact our customer services department.

Any damage due to improper use is not covered by the warranty. The warranty does not cover any modifications to the appliance or the use of non-original Dometic parts. The warranty does not apply if the installation and operating instructions are not adhered to and no liability shall be entertained.

Limitation of liability

All information and guidance in these operating instructions were prepared after taking into consideration the applicable standards and regulations as well as the current state of the art. Dometic reserves the right to make changes at any time which are deemed to be in the interest of improving the product and safety.

Dometic will assume no liability for damage in the case of :

- Non-observation of the operating instructions
- Application not in accordance with the regulations or provisions
- Use of non-original spare parts
- Modifications and interferences to the appliance
- Effect of environmental influences, such as
 - temperature fluctuations
 - humidity

Customer services

Dometic offers a pan-European customer service network. Find your authorised customer service centre by calling the phone number indicated in the EuroService Network book, EuroService Network - which accompanies every refrigerator. You can also obtain the address information of the nearest customer service from www.dometic.com. When contacting Dometic Customer Services, please state the model, product number and serial number together with the MLC code, if applicable. You will find this information on the rating plate inside the refrigerator. We recommend that you note this data in the field provided on the front page of the operation manual.

Spare parts

Parts can be ordered throughout Europe from our customer services. Always give the model and product number when you contact the customer service! You will find this information on the rating plate inside the refrigerator.

DOMETIC REFRIGERATOR

Environmental notice

Refrigerators manufactured by Dometic GmbH are free of CFC/HCFC and HFC. Ammonia (a natural compound of hydrogen and nitrogen) is used in the cooling unit as a coolant. Non-ozone-hazardous cyclopentane is used as a propellant for manufacturing PU foam insulation.

In order to ensure that the recyclable packaging materials are re-used, they should be sent to the customary local collection system.

The appliance should be transferred to a suitable waste disposal company that will ensure re-use of the recyclable components and proper disposal of the rest. For eco-friendly draining of the coolant from all absorber refrigeration units, a suitable disposal plant should be used.

Energy-saving tips

- At an average ambient temperature of 25°C, it is sufficient to operate the refrigerator at middle thermostat setting.
- Where possible, always store precooled products.
- Do not expose the refrigerator to direct sunlight.
- Ensure that air circulation of the cooling unit is not obstructed.
- Defrosting at regular intervals saves energy (see "Defrosting"). Open the refrigerator door only for a short period of time when removing products.
- Run the refrigerator for about 12 hours before filling it.

Safety instructions

Application according to regulations

This refrigerator is designed for installation in recreation vehicles such as caravans or motorhomes. The appliance has been type approval tested for this application in accordance with the EC Gas Directive.

The refrigerator is to be used solely for storing foodstuffs.

⚠ WARNING! The refrigerator is not suitable for the proper storage of medication. Please observe the instructions in the medication package inserts.

User's responsibility

Anyone operating the refrigerator must be familiar with the safe handling and understand the advice in these operating instructions. Children may only operate the appliance, if they have been made aware of how to operate the refrigerator safely and the dangers attending incorrect operation.

Protection of children when disposing of the equipment

⚠ WARNING: When disposing of the refrigerator, detach all refrigerator doors and leave the storage racks in the refrigerator. In this way inadvertent entrapment and suffocation is prevented.

Working upon and checking the refrigerator

⚠ WARNING: Work on gas equipment, exhaust system and electrical facilities must be carried out by authorised personnel only. Substantial damage to property and / or injury to persons can arise through unprofessional procedures.

⚠ WARNING: Never use an unshielded flame to check gas bearing parts and pipes for leakage! There is a danger of fire or explosion.

⚠ WARNING: Never open the absorber cooling unit! It is under high pressure. There is a danger of injury.

Information on coolant

Ammonia is used as a coolant. This is a natural compound also used in household cleaning agents (1 litre of Salmiak cleaner contains up to 200g of ammonia - about twice as much as is used in the refrigerator). Sodium chromate is used for corrosion protection (1.8% by weight of the solvent).

In the event of leakage (easily identifiable from the strong odour), proceed as follows:

- Switch off the appliance.
- Air the room thoroughly.
- Inform authorised customer services.

Note: For your safety it was ascertained in an expert's report that no impairment of health exists when the coolant is discharged.

Operating the refrigerator with gas

It is imperative that the operating pressure corresponds to the data specified on the rating plate of the appliance. Compare the operating pressure of the rating plate with the data specified on the pressure reducing valve of the liquid gas cylinder.

⚠ WARNING: Operating the appliance with gas is not permitted

- At petrol stations
- On ferry boats
- While transporting the caravan / motorhome by a transporter or breakdown vehicle.

There is danger of fire!

Leave the equipment switched off.

Safety instructions when storing foodstuffs

Instructions for storing food in a refrigerator:

No refrigerator of any kind can improve the quality of the food; refrigerators can only maintain the food's quality for a short duration as from the time of storing it.

Please observe the following particular conditions for storing food in a refrigerator that is built into a vehicle:

- A change in the climatic conditions such as temperature fluctuations
- High temperatures inside the vehicle when it is closed and parked in direct sunlight (temperatures are possible up to 50°C)
- A refrigerator built in behind a window and exposed to direct sunlight
- Storing the products too soon, i.e. shortly after starting up the appliance for use
- Use of the refrigerator during travel with the power supply of 12V DC
- Fluctuations in the power supply at the parking place when using the energy type 230V AC (mains voltage)

Under these particular conditions the refrigerator cannot guarantee reaching the temperature needed for perishables.

Perishables include all products with a stipulated use-by date and a minimum storage temperature of +4°C or less, especially for meat, poultry, fish, sausages, pre-packed foods.

Storing foodstuffs:

- Pack raw and cooked foods separately (e.g. in containers, aluminium foil, etc.).
- Only remove the outside packaging of single packs if all the necessary information, e.g. the use-by date, can also be read on the single packs.
- Please observe the instructions and information regarding the use-by-date on the out outside packaging of the food.

DOMETIC REFRIGERATOR

- Do not leave cooled goods outside the refrigerator for too long.
- Place the foods with the next use-by date at the front, accordingly.
- Pack away any left-over food and eat at the first opportunity.
- Wash your hands before and after handling any food.
- Regularly clean the inside of the refrigerator.

Please observe the instructions and information regarding the use-by date on the outside packaging of the food.

Please observe section "Cleaning" of this instruction.

Note: The cooling unit's performance is influenced by ambient temperatures. Please select the medium setting for ambient temperatures between +15°C and +25°C (refer to Setting of cooling compartment temperature). The unit operates within its optimum performance range. Dometic refrigerators work according to the absorption principle. For physical reasons, an absorption system responds slowly to changes made by the thermostat controller, by loss of cooling energy through opening the door or during storing food. The devices meet cooling performance requirements of the Climatic Class SN acc. to EN/ISO 7371 in the temperature range of the +10 to +32°C ambient temperature.

Cold air can restrict the performance of the unit. Install the winter covers if you discover any loss of cooling performance when outdoor temperatures are low (see operation during low outside temperatures).

For ambient temperatures exceeding to +32°C for longer period of time, it is recommended installing Dometic additional fan (item no.2412985-01).

Refrigerator rating plate

The rating plate is to be found on the inside of the refrigerator. It contains all important details of the refrigerator. You can read off from this

the model identification, the product number and the serial number. You will need these details whenever you contact the customer service centre or when ordering spare parts.

Dometic									
TYPE	C 40/110	CLIMATE CLASS	SN						
MOD. NO.	RMS 8400	1	PROD. NO.	00921084272	2	C 00	SER. NO.	99900165	3
BRUTTOINHALT TOTAL CAP. VOLUME BRUT	80 l 95 l	VERDAMPFERFACH FREEZER COMP. VOLUME COMPT BT	8 l 0 l	NUTZINHALT USEFUL CAP. VOLUME NET	77 l 82 l				
~ 230-240V / 125 W 12 V / 120 W	LPG	Q _h : 0.252 kW (HS) R _e : 18.3 g/h	4		5	13+ 28-30/07 138/1P 28-30 mbar 13P 37			
CE 0093 BL3214	G30, G31	p = 20/07 mbar							
ABSORPTION	NH ₃ = 115 g	Na ₂ CO ₃ = 7.0 g	p max = 35 bar						
37 °C	CE 0095	021854	2.600						
FKW, FCKW FREI / CPC, HCFC FREE			MADE IN GERMANY 00257364562						

1 - Model Number

2 - Product Number

3 - Serial Number

4 - Electrical rating details

5 - Gas pressure

The cooling unit's performance is influenced by ambient temperatures. Please select the medium setting for ambient temperatures between +15°C and +25°C (refer to Setting of cooling compartment temperature.) The unit operates within its optimum performance range.

Dometic refrigerators work according to the absorption principle. For physical reasons, an absorption system responds slowly to changes made by the thermostat controller, by loss of cooling energy through opening the door storing food. The devices meet the cooling performance requirements of the Climatic Class SN acc. to EN/ISO 7371 in the temperature range of +10°C to +32°C ambient temperature.

For temperatures below +10°C, winter covers should be installed. For ambient temperatures exceeding +32°C for a longer period of time, it is recommended installing Dometic additional fan (item no. 241 2985 - 00).

Description of refrigerator

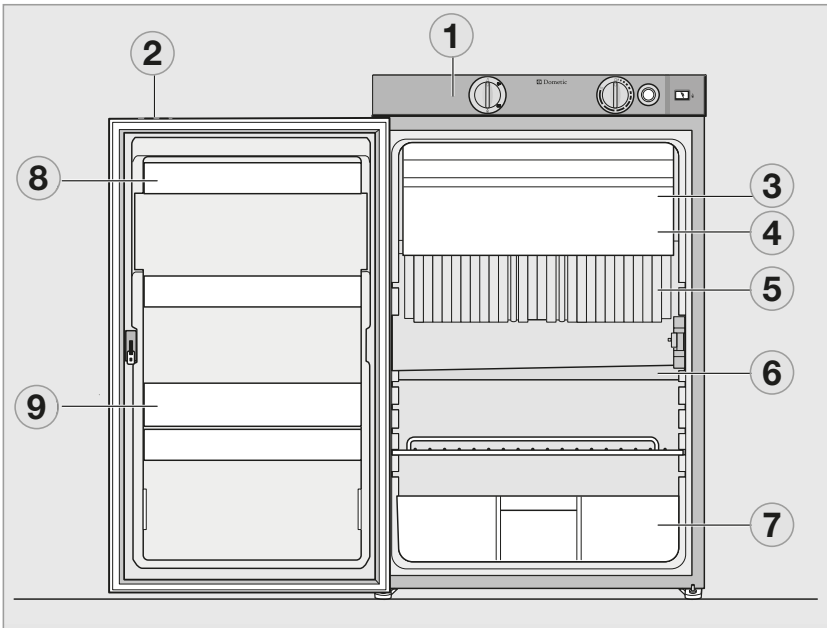

(Appearance is model specific)

- 1 - Operating controls
- 2 - Door locking button
- 3 - Freezer compartment (removable)
- 4 - Insertable grid shelf (available as option, to be used when freezer compartment is removed)
- 5 - Post-evaporator for cooling compartment
- 6 - Condensation water drain channel
- 7 - Vegetable bin
- 8 - Upper door shelf with flap, egg shelf available as option may be inserted
- 9 - Lower door shelf with bottle holders

DOMETIC REFRIGERATOR

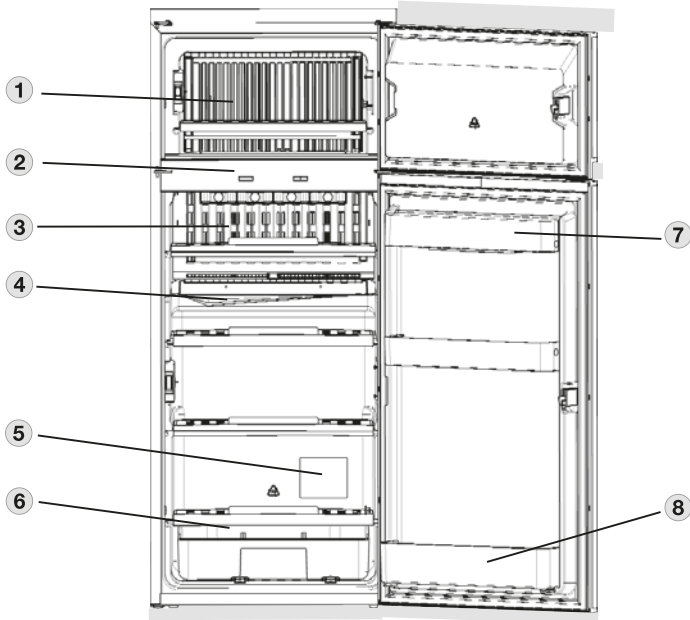

- 1 - Freezer compartment
- 2 - Operating controls
- 3 - Post evaporator for cooling compartment
- 4 - Condensation water drain channel
- 5 - Data plate
- 6 - Vegetable bin
- 7 - Upper door shelf with flap, egg shelf available as option may be inserted.
- 8 - Lower door shelf with bottle holders

Refrigerator operation

The refrigerator is equipped to operate on three power modes:

- Mains voltage (230V AC)
- Direct-current voltage (12V DC)
- Gas (liquid gas propane/butane)

Select the desired power mode by the energy selector switch (battery igniter type models) or the MODE button (MES, AES). Appliances with automatic energy selection (AES) are additionally provided with “automatic mode” function. The AES system automatically selects the best energy source for each particular situation.

Cleaning

Before starting up the refrigerator, it is recommended that you clean it inside and repeat this at regular intervals.

Use a soft cloth and lukewarm water with a mild detergent. Then wipe out the appliance with clean water and dry thoroughly.

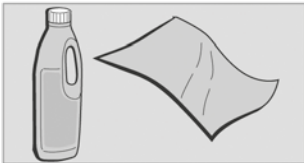

Fig. 1

To avoid material alterations, do not use soap or hard, abrasive or soda-based cleaning agents.

Do not allow the door seal to come into contact with oil or grease.

Maintenance

- In compliance with the applicable regulations, please note that the gas unit and the connected ventilation ducts must be checked by authorised technical personnel after first use and after every other year for compliance with the European Standard EN 1949. A test certificate has to be issued. It is the user's responsibility to arrange this test.

- The gas burner must be inspected and cleaned as necessary at least once a year. When using liquefied petroleum gas (tank or refill cylinders) the maintenance interval is reduced to half-yearly or quarterly. Keep the evidence of maintenance work carried out on your refrigerator.
- Work on gas and electrical equipment shall be carried out by qualified personnel only.

It is recommended that this is carried out by an authorised customer services department.

We recommend maintenance following an extended shutdown of the vehicle. Please contact our customer services.

Electrical Operation

12V-Voltage (on-board power supply)

⚠ CAUTION: The refrigerator should only be used in 12DC-operation while the vehicle's engine is running, otherwise the on-board-battery would be discharged within a few hours!

⚠ CAUTION: This option should only be selected where the supply voltage of the connection for power supply corresponds to the value specified on the data plate. Any difference in values may result in damage the appliance.

Gas Operation (liquid gas)

- The refrigerator must be operated using liquid gas (propane, butane) (no natural gas or town gas).
- When using LPG gas, please consider that the burner needs cleaning at shorter intervals due to the gas combustion method (2 - 3 times per year recommended).
- In Europe, gas operation is permitted while travelling only on the condition that the gas system of the vehicle is equipped with a hose rupture protection. The national regulations of the respective country must be observed.
- For physical reasons, gas ignition faults could occur starting from an altitude above sea level of approx. 3280ft/1000m (No malfunction!).

DOMETIC REFRIGERATOR

- On the initial refrigerator start-up or after a cylinder change, air may be trapped in the gas line. To purge the air from the lines, switch on the refrigerator and any other gas appliances (e.g. stove) for a short time. The gas ignites without delay.
- Each refrigerator with manual ignition is equipped with an automatic flame safety valve which interrupts the gas supply automatically after approx. 30 seconds when flame has extinguished.

⚠ CAUTION: As a basic rule, gas operation is prohibited in petrol stations!

Prior to starting the refrigerator in gas mode:

- Open the gas cylinder valve
- Open the shut-off valve for gas supply to refrigerator

Manual energy selection / automatic ignition (RMS 8551 RMD 8551, RML 9331) MES (fridge models)



Fig. 2 rly. 1

- 1 - Power ON/OFF switch
- 2 - Energy selector button 230V ~
- 3 - Energy selector button GAS
- 4 - Energy selector button 12V =
- 6 - Temperature level selection
- 7 - Temperature level display
- 8 - Indicator LED failure / Reset button
GAS FAILURE

Switching ON/OFF

- Switch ON by pressing button (1), 2s
- Switch OFF by pressing button (1), > 2s

230V AC operation

- Select "Mains voltage" by pressing button (2)

- Set temperature step by pressing button (6)

12V DC operation (vehicle's battery)

- Select "Battery voltage" by pressing button (4)
- Set temperature step by pressing button (6)

Gas operation

- Select "Gas" by pressing button (3)
- Set temperature step by pressing button (6)

RMS 8551/RMD 8551/RM9xx1 MODELS MES appliances (manual energy selection)

Electrical operation

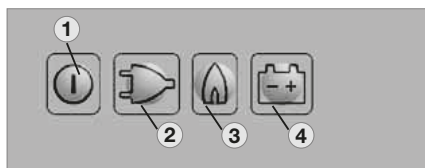

Fig. 3

To start the refrigerator, press button (1) for 2 seconds.

The refrigerator starts with the last selected type of energy.

230V operation : 
Press button (2) :

12V operation : 
Press button (4) :

Gas operation

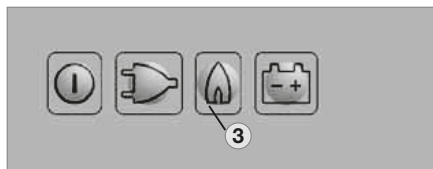



Fig. 47

Gas operation : 
Press button (3) :

The ignition process is activated automatically by means of an automatic igniter.

Note: The flame extinguishes after reaching the preset cooling compartment temperature and ignites again if the cooling compartment temperature increases again. If the flame is not lit after the first ignition attempt, the automatic igniter repeats the ignition twice (duration 30 s) at time intervals of 2 minutes. If the flame is not lit afterwards, a fault is indicated.

Setting of cooling compartment temperature

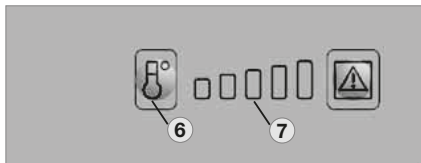

Fig. 5

Select the desired cooling compartment temperature by pressing button (6) .

The LED display (7) of the selected temperature setting is illuminated.

The scale starts with MIN position at the left LED position (small bar = highest temperature) and climbs up to MAX position at the right LED position (large bar = lowest temperature).

Note: The temperature levels do not relate to absolute temperature values.

Additional features

- The brightness of the display reduces after a few seconds if no other buttons are pressed. The indicator lights again if a button is pressed. Press the button again to activate the required function.
- Failures are indicated by flashing of the failure indicator LED.
- Should the door be kept open for too long (more than 2 minutes), an acoustic signal is initiated (pulsing whistle tone).
- Should the electronic control detect any failure, an acoustic signal will sound (pulsing whistle tone). At the same time the display starts flashing (for trouble-shooting, please refer to page 162).

Gas operation with internal batteries (optional)

An optional battery compartment in the electronics case for internal (self-contained) power supply of the electronics is available for the model variants RM 8xx1 and RM 8xx5 (appliances with electronics).



Fig. 6

Load the battery compartment with batteries (8 x AA 1.5 V) before operating the refrigerator.

All operating modes can be selected while the on-board 12 V DC power supply is active. The internal voltage is disconnected.

If the on-board 12 V DC power supply is not present or there is an interruption of the mains power supply during operation, the electronics automatically switch to the internal (battery) power supply. The refrigerator can now only be operated in the gas mode.

All LED indicators except the GAS LED are not lit during operation with internal batteries. The GAS LED flashes every 15 seconds.

If a button is pressed, the temperature level LEDs (7) also light.

If the battery voltage is too low, an acoustic signal (whistle tone) sounds every 15 seconds. Then replace the batteries in the battery compartment.

DOMETIC REFRIGERATOR

Inserting / changing the batteries

- Switch off the refrigerator, as described in section 'Shutting of the refrigerator'

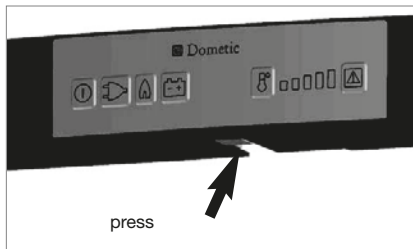

Opening battery compartment

Fig. 7

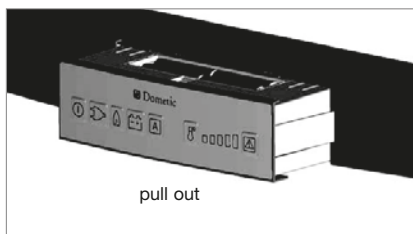

Fig. 8

Note: Batteries (8 x AA 1.5V) are not included!

⚠ WARNING:

- Observe the correct polarity!
- Do not connect non-rechargeable batteries to a charger.
- Remove rechargeable batteries from the battery compartment before charging.
- Avoid short circuits on the contacts in the battery compartment!
- Remove discharged batteries.
- Remove the batteries from the battery compartment if the refrigerator will not be used for a long time.
- Do not mix different types of batteries.

Explanation of operating controls

The control panel buttons are not accessible when the refrigerator door is closed. Open the bottom door to reach the operating buttons.

Depending on the door opening direction, there are two LEDs on the left or right edge of the control panel. The outer LED (1) indicates that the refrigerator is operational (blue). The other LED (2) lights red in the event of a fault.



Fig. 9

Refrigerators for self-contained (gas) operation contain two battery compartments in the control panel which are located on the left and right next to the button bar.



Fig. 10



Fig. 11

Manual energy selection / automatic ignition (RMD 8xx1) MES



Fig. 12

- 1 - Power ON/OFF switch
- 2 - Energy selector button 230V ~
- 3 - Energy selector button GAS
- 4 - Energy selector button 12V =
- 6 - Frameheating
- 7 - Temperature level selection

- 8 - Temperature level display
- 9 - Indicator LED failure / Reset button
GAS FAILURE

Switching ON/OFF

- Switch ON by pressing button (1), 2s
- Switch OFF by pressing button (1), > 2s

230V AC operation

- Select "Mains voltage" by pressing button (2)
- Set temperature step by pressing button (7)

12V DC operation (vehicle's battery)

- Select "Battery voltage" by pressing button (4)
- Set temperature step by pressing button (7)

Gas operation

- Select "Gas" by pressing button (3)
- Set temperature step by pressing button (7)

RMS 8551/RMD 8551/ RM9xx1 models MES-appliances (manual energy selection)

Electrical operation

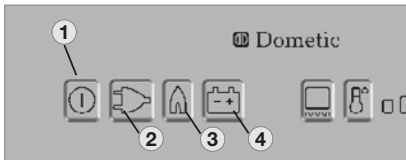



Fig. 13

To start the refrigerator, press button (1) for 2 seconds.

The refrigerator starts with the last selected type of energy.

230V operation : 

12V operation : 

Gas operation



Fig. 14

Gas operation :

Press button (3) : 

The ignition process is activated automatically by means of an automatic igniter.

Note: The flame extinguishes after reaching the preset cooling compartment temperature and ignites again if the cooling compartment temperature increases again. If the flame is not lit after the first ignition attempt, the automatic igniter repeats the ignition twice (duration 30 s) at time intervals of 2 minutes. If the flame is not lit afterwards, a fault is indicated.

Setting of cooling compartment temperature

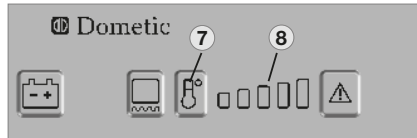

Fig. 15

Select the desired cooling compartment temperature by pressing button (7) .

The LED display (8) of the selected temperature setting is illuminated.

The scale starts with MIN position at the left LED position (small bar = highest temperature) and climbs up to MAX position at the right LED position (large bar = lowest temperature).

Note: The temperature levels do not relate to absolute temperature values.

DOMETIC REFRIGERATOR

Additional features

- The brightness of the display reduces after a few seconds if no other buttons are pressed. The indicator lights again if a button is pressed. Press the button again to activate the required function.
- Failures are indicated by flashing of the failure indicator LED.
- Should the door be kept open for too long (more than 2 minutes), an acoustic signal is initiated (pulsing whistle tone).
- Should the electronic control detect any failure, an acoustic signal will sound (pulsing whistle tone). At the same time the display starts flashing (for trouble-shooting, please refer to page 162).

Gas operation with internal batteries (optional)

An optional battery compartment in the electronics case for internal (self-contained) power supply of the electronics is available for the model variants RMD 85x1 and RMD 85x5 (appliances with electronics).

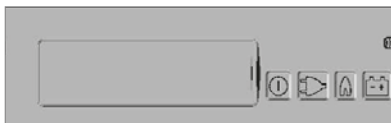

Fig. 16

Load the battery compartment with batteries (8 x AA 1.5 V) before operating the refrigerator.

All operating modes can be selected while the on-board 12 V DC power supply is active. The internal voltage is disconnected.

If the on-board 12 V DC power supply is not present or there is an interruption of the mains power supply during operation, the electronics automatically switch to the internal (battery) power supply. The refrigerator can now only be operated in the gas mode.

All LED indicators except the GAS LED are not lit during operation with internal batteries. The GAS LED flashes every 15 seconds.

If a button is pressed, the temperature level LEDs (7) also light.

If the battery voltage is too low, an acoustic signal (whistle tone) sounds every 15 seconds.

Then replace the batteries in the battery compartment.

Inserting / changing the batteries

Switch off the refrigerator, as described on page 161 Shutting off the refrigerator.

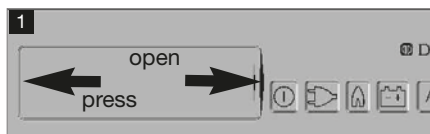

Opening left battery compartment

Fig. 17



Opening right battery compartment

Fig. 18

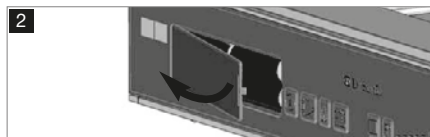

Note: Batteries (8 x AA 1.5V) are not included!

⚠ WARNING:

- Observe the correct polarity!
- Do not connect non-rechargeable batteries to a charger.
- Remove rechargeable batteries from the battery compartment before charging.
- Avoid short circuits on the contacts in the battery compartment!
- Remove discharged batteries.
- Remove the batteries from the battery compartment if the refrigerator will not be used for a long time.
- Do not mix different types of batteries.

Frame heating (fridge freezer models only)

All fridge freezer models are equipped with a frame heating (12VDC/3,5W) around the freezer compartment. During summer months with high temperatures and humidity the metal frame may have water droplets forming. To evaporate these droplets switch on the frame heating with button (6).



Fig. 19

The operating time of the frame heater can be set to 2 hours, 5 hours or continuous operation. After selecting the operating time using the button (6), the temperature level indicator (8) is extinguished for a short time to show the set operating time for a few seconds. The display then returns to the temperature level indicator.

Operating time: 2 hours

Press button (6) once

Display



Operating time: 5 hours

Press button (6) twice

Display



Permanent operation

Press button (6) three times

Display



⚠ WARNING: In order to prevent discharge of the onboard battery, change the frame heater from continuous operation to another operating time or switch it off.

Note: The frame heater is active for 30 minutes after switching on and then switches itself off and on again at time intervals of 5 minutes.

Door locking

⚠ WARNING: As a basic rule, shut and lock the refrigerator before you start your journey!

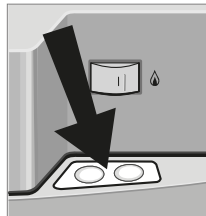

Fig. 24
Fig. 20



Fig. 25
Fig. 21

Open the door by pressing the locking button and pull open (see Fig. 20).

Shut the door again by pushing it to close. The snapping into the lock can be heard.

While the vehicle is parked, the locking hook may be fixed to facilitate opening of the door (Fig. 22-25).

Fastening and releasing the door lock hook when parking the vehicle

If the vehicle is parked for a longer period of time, the locking hook may be clamped by means of a lockbar. The door may now be opened by just pulling it without need of pressing the locking button.

DOMETIC REFRIGERATOR

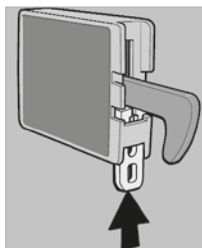

Fastening

Fig. 22

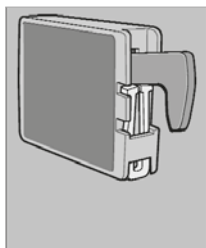
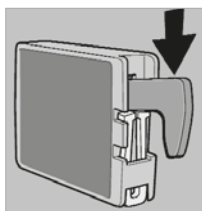

Fig. 23



Releasing

Fig. 24

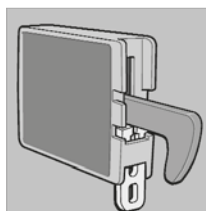

Fig. 25

Lighting

The interior lighting is controlled using a door contact. Should the door be kept open more than 2 minutes, an acoustic signal is initiated (pulsing whistle tone). **(except for models with battery igniter).**

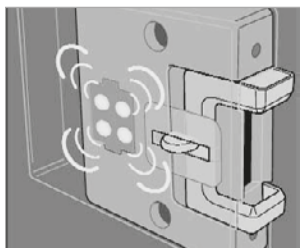

Fig. 26

Note: Please contact the authorized Dometic Service if a failure occurs.

Positioning the storage racks

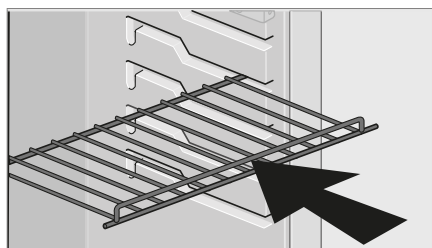

Fig. 27

The storage racks may be pulled out by smoothly lifting them and may be positioned as desired.

Removable freezer compartment

RMS 8551 under counter fridge

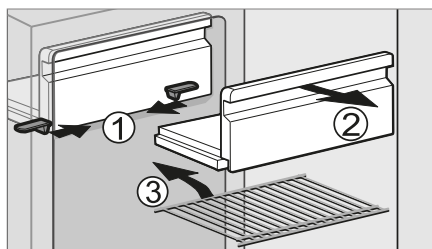

Fig. 28

To enlarge the cooling compartment, just remove the freezer compartment.

1. Unlock the freezer compartment on both sides.
2. Pull the freezer compartment out. Store the freezer compartment safely in order to prevent damage

Note: Once the freezer compartment is removed, an additional storage rack (3.) may be installed. The storage rack is a piece of extra equipment and may be obtained by Dometic.

Winter operation

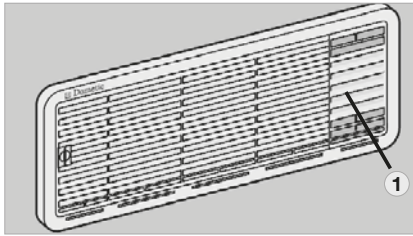

Fig. 29

In winter, check that the ventilation grilles and the exhaust duct system (1) have not been blocked by snow, leaves, etc.

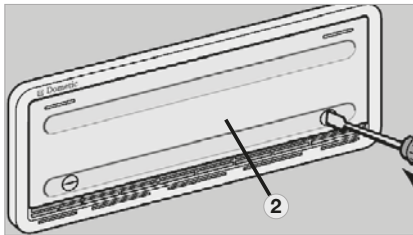

Fig. 30

When the outside temperature falls below $+10^{\circ}\text{C}$, the winter covers should be fitted. This protects the unit from excessively cold air which could have adverse effects on the performance of the unit.

Covers may be supplied as part of the specification of your caravan or alternatively are available through most Swift Group Dealers.

Note: You should also attach the winter covers if the vehicle is taken out of service for a longer period of time or while it is being cleaned from the outside.

⚠ WARNING: Refrigerators up to 130l capacity*- Do not install the top winter cover during gas operation.

Winter operation (fridge freezer models)

In winter, check that the ventilation grilles and the exhaust duct system (1) have not been blocked by snow, leaves, etc.

Note: Winter covers are not supplied as standard on most models.

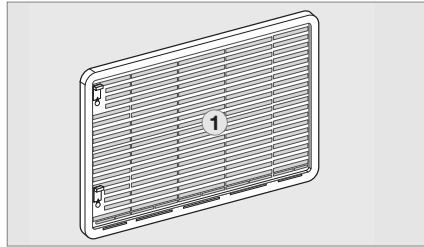

Fig. 31

When the outside temperature falls below $+10^{\circ}\text{C}$, the winter cover (2) should be fitted. This protects the unit from excessively cold air which could have adverse effects on the performance of the unit.

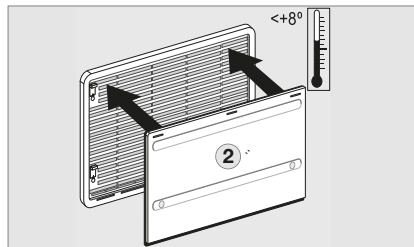

Fig. 32

You should also attach the winter covers if the vehicle is taken out of service for a longer period of time or while it is being cleaned from the outside.

Storing food and making ice cubes

Storing products in the cooling compartment

- Switch the refrigerator on approx. 12 hours before filling it.
- Always store pre-cooled foods in the refrigerator. Make sure that the food is well cooled when it is bought and also when transporting it. Use insulated cooling bags.
- Open the refrigerator door only for a short period of time when removing products.

DOMETIC REFRIGERATOR

- Products must be packed - best of all in closed containers, wrapped in aluminium foil or similar - and stored separately from each other, in order to prevent drying out or odours.
- Allow foods that have been warmed up to cool down before storing.
- Avoid storing products in the refrigerator that could emit volatile flammable gases.
- Do not overfill the storage grids and compartments to prevent obstructing the internal air circulation.
- Maintain a clearance of approx. 5 - 10 mm between chilled products and post-evaporator ("cooling fins").
- Do not expose the refrigerator to direct sunlight. Please bear in mind that the temperature inside a closed vehicle increases sharply if exposed to sunlight and that this can reduce the efficiency of the refrigerator.
- Ensure that air circulation of the cooling unit is not obstructed. Keep the ventilation grilles free from obstructions.

Storing products in the freezer compartment

- Do not keep carbonated drinks in the freezer.
- The freezer compartment is suitable for making ice cubes and for short-term storage of frozen food. It is not suitable as a means of freezing foods.

When ambient temperatures are lower than +10°C and the refrigerator is exposed to these temperatures for extended periods of time, an even regulation of freezer temperature cannot be guaranteed for system related reasons. This can cause the temperature in the freezer to rise and the stored goods to melt.

Refrigerator compartments

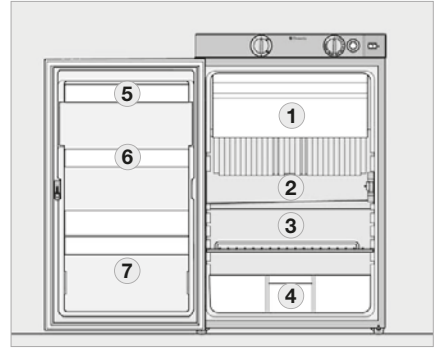

Fig. 33

- 1 - Freezer compartment:**
already frozen food (deep-frozen food)
- 2 - Middle compartment:**
Dairy products, convenience food
- 3 - Bottom compartment:**
Meat, fish, food for defrosting
- 4 - Vegetable compartment:**
Salads, vegetables, fruit
- 5 - Top door shelf:**
Eggs, butter
- 6 - Middle door shelf:**
Cans, dressings, ketchup, jam
- 7 - Bottom door shelf (drinks compartment):**
Drinks in bottles or bags

Positioning the storage racks

The storage racks may be pulled out by loosening the two locking devices (1) underneath. For loosening pull the slider to the middle, for fastening pull them sideways.

Two of the storage racks are secured. In this way inadvertent entrapment and suffocation of children is prevented, if the storage racks are removed. To protect children it must be avoided to create space for children in the cooling compartment.

⚠ WARNING: Do not remove these storage racks. Thus children have no space to be entrapped in the refrigerator.

If it is necessary to remove these storage racks (i.e. for cleaning) loosen the locking pins (2) at first as shown, by means of a suitable screw driver.

Put in place the locking pins after removing the storage racks.

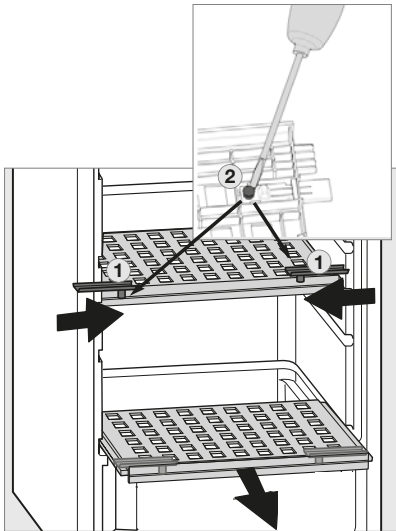

Fig. 34

Shutting off the refrigerator

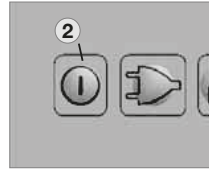

Fig. 35

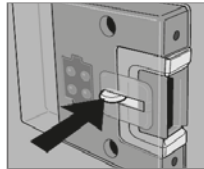

Fig. 36

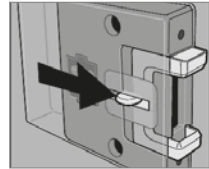

Fig. 37

- Switch off MES and AES models by pressing button (2). Keep button (2) pressed for 3 seconds. The display disappears and the appliance is fully switched off (Fig. 35).
- Release the locking mechanism of the door lock by pushing it and shift it to the front. If the door is shut in this position, a small gap is nevertheless kept open to prevent formation of mildew.
- If the refrigerator is to be taken out of service for an extended period of time, close the onboard shut-off valve and the cylinder valve.

DOMETIC REFRIGERATOR TROUBLESHOOTING

Troubleshooting

Failure: The refrigerator does not cool sufficiently.

Possible cause	Action you can take
Inadequate ventilation to the unit	Check that the ventilation grilles are not covered
Thermostat setting is too low	Set thermostat to a higher level
The condenser is heavily frosted	Check that the refrigerator door closes properly
Too much warm food has been stores inside within a short period of time	Allow warm food to cool down before storage
The appliance has been running for only a short period of time	Check whether the cooling compartment works after approx 4-5 hours
Ambient temperatures too high	Regularly remove ventilation grilles.

Failure: The refrigerator does not cool in gas operation mode.

Possible cause	Action you can take
Gas cylinder empty	Change gas cylinder
Is the upstream shut-off device open?	Open shut-off device
Air in the gas pipe?	Switch off the appliance and start again. Repeat this procedure 3-4 times, if necessary.

Failure: The refrigerator does not cool in 12 V operation.

Possible cause	Action you can take
On-board fuse defective	Fit new fuse
On-board battery displaced	Check battery, charge it
Engine not running	Start engine
Heating element defective (please refer to failure indication)	Please inform the Dometic Customer Services.

Failure: The refrigerator does not cool in 230 V operation.

Possible cause	Action you can take
On-board fuse defective	Fit new fuse
Vehicle not connected to mains supply voltage	Make a connection to a mains power supply
AES: Gas operation despite connection to the mains supply voltage?	Appliance switches to gas operation due to insufficient mains supply voltage (automatically switches back to 230 V operation)
Heating element defective (please refer to failure indication)	Please inform Dometic Customer Services

Information on failure display and trouble-shooting

- Refrigerators with an electronics system (MES, AES) indicate the occurrence of a malfunction by the LED or display flashing.
- If a malfunction occurs, the indicator LED “Failure” (8) flashes simultaneously. In the case of AES models an acoustic alarm sounds.

Before notifying the authorised Service Center, please check whether:

- the instructions in section “Operating the refrigerator” have been observed.
- the refrigerator stands level.
- it is possible to operate the refrigerator with any available power source.

Status indicators



MES

Fig. 38

- 1 - Button ON / OFF
- 2 - Energy selector switch 230 V AC
- 3 - Energy selector switch GAS
- 4 - Energy selector switch 12V DC
- 6 - temperature level button
- 7 - temperature level display
- 8 - fault LED / GAS FAULT reset button

DOMETIC REFRIGERATOR TROUBLESHOOTING

Operation with on-board 12 v power supply

Indicator	Fault	Remedy
(2) and (8) flashing and acoustic signal 20s	230 V mode: "230V" not available or voltage too low	Check mains power connection, mains voltage, fuse
(4) and (8) flashing and acoustic signal 20s	12 V mode: "12V" not available or voltage too low	Check 12V connection, on-board battery, fuse
(3) and (8) flashing and acoustic signal 20s	Gas mode: Flame not ignited	Check gas supply (gas bottle, gas valve) Press the (8) button after clearing the fault
Acoustic signal, 15s at two minute intervals	Interior lighting is switched on	Close door, check door contact
(2) and (7) flashing and acoustic signal 20s	230 V mode: 230V heating element defective	Arrange replacement of 230V heating element, contact Customer Service
(4) and (7) flashing and acoustic signal 20s	12 V mode: 12V heating element defective	Arrange replacement of 12V heating element, contact Customer Service
(7) flashing and acoustic signal 20s	Temperature sensor without contact or defective	Contact Customer Service
(3) and (7) flashing and acoustic signal 20s	Burner defective or cooling unit defective	Check burner, burner nozzles, if necessary contact Customer Service and arrange replacement

**Operation with batteries
(internal power supply)**

Indicator	Fault	Remedy
(3) and (8) flashing brightly	Flame not ignited	Check gas supply (gas bottle, gas valve) Press the (8) button after clearing the fault
(3) and (7) flashing brightly	Burner defective or cooling unit defective	Check burner, burner nozzles, if necessary contact Customer Service and arrange replacement
Acoustic signal at 15 second intervals	Undervoltage detection (internal batteries)	Replace batteries
Automatic switching from external to internal power supply does not function (absence of the onboard 12V power supply for the electronics)	Refrigerator does not function, gas operation not possible although the batteries are inserted	Switch off the refrigerator and start again The onboard power supply was interrupted during the starting of the gas operation Note: No automatic switching is performed during the ignition.

THETFORD MINI GRILL

Mini Grill Operation

(Sprite Freedom) - 3 Gas Burner & Grill



⚠ WARNING:

- Appliance and accessible parts become hot during use.
- Avoid touching heating elements.
- Children less than 8 years of age shall be kept away unless continuously supervised.
- This appliance can be used by children aged from 8 years and above, persons with reduced physical, sensory or mental capabilities and/or lack of experience and knowledge only if they have been given supervision or instruction concerning use of the appliance in a safe way and understand the hazards involved.
- Children shall not play with the appliance.
- Cleaning and user maintenance shall not be made by children without supervision.
- Unattended cooking on a hob with fat or oil can be dangerous and may result in fire.
- Never extinguish a fire with water, switch off the appliance and cover flame with lid or fire blanket.
- Danger of Fire: Do not store items on the cooking surface.
- Do not use harsh abrasive cleaners or sharp metal scrapers to clean the oven door glass since they can scratch the surface, which may result in shattering of the glass.
- Never use a steam cleaner to clean appliance.

Hob & Grill Burner

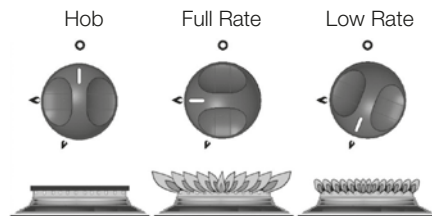

Introduction

This appliance is designed for cooking foods, any other use is incorrect and dangerous. Failure to install the appliance correctly or improper use, will invalidate any warranty or liability claims.

This appliance must be installed in accordance with the local, national and European regulations in force. Particular attention shall be given to the requirements regarding ventilation. Read the instructions before installing or using the appliance. The appliance **MUST** be installed by an approved competent person.

Our policy is one of continuous development and improvement. Specifications and illustrations may change subsequent to publication.

Provision of ventilation

The use of a gas cooking appliance results in the production of heat, moisture and products of combustion in the room in which it is installed. Ensure that the kitchen is well ventilated especially when the appliance is in use: keep natural ventilation holes open or install a mechanical ventilation device (mechanical extractor hood).

Prolonged intensive use of the appliance may call for additional ventilation, for example opening of a window, or more effective ventilation, for example increasing the level of mechanical ventilation where present.

The room containing the cooker should have an air supply in accordance with local and national/European standards.

Note:

- Appliance should only be used with Liquefied Petroleum Gas (LPG)
- Use only the Gas Pressures specified
- This appliance is approved for use with either Propane or Butane.
- We recommend using Propane for this appliance.
- Butane may be used, although the appliance performance may be compromised when the ambient temperature is below 10°C.
- Butane should not be used when the ambient temperature is below 5°C.
- This appliance MUST be earthed

⚠ WARNING: This appliance is not intended to be operated by means of an external timer or separate remote-control system.

Operation

The burners on the appliance have fixed aeration and no adjustment is required. The burners should flame as follows:-

Propane - The flames should burn quietly with a blue/green colour with no sign of yellow tips.

Butane - Normally on initial lighting, a small amount of yellow tipping will occur and then slightly increases as the burner heats up.

The burners are controlled individually and each is monitored by a thermocouple probe. In the event the burner flames are accidentally extinguished, turn off the burner control and do not attempt to re-ignite the burner for at least one minute

Note: Before using the appliance for the first time, remove any surface protection film, ie plastic coating. Clean all surfaces with hot soapy water to remove any residual protective covering of oil and rinse carefully.

Using the Hotplate Gas Burners

1. Ensure gas supply is connected and turned on.
2. Push in the control knob and turn anticlockwise to full rate – large flame (🔥).
3. Continue depressing the knob whilst holding a lighted match or taper to the burner. For models fitted with spark ignition the procedure is similar except that burner is ignited by depressing the ignition button located on the fascia.
4. After the burner is lit continue depressing the knob for approximately 10 - 15 seconds.
5. Release knob and turn to required heat setting.
6. If burner has not lit within 15 seconds, release knob and wait at least 1 minute before repeating operations (2) to (5).
7. To turn off, rotate the control knob until the line on the knob is aligned with dot on the control panel.

Always make sure the control knob is in the off position when you have finished using the hotplate burners.

⚠ WARNING:

- Children should be supervised to ensure they do not play with the appliance
- Glass lids may shatter when heated. Turn off the hotplate and allow it to cool before closing the glass lid.
- Remove all spillage from the surface of the glass lid before opening.

Using the Grill

1. Ensure gas cylinder/supply is connected and turned on.
2. Open door, push in the control knob and turn to the large flame symbol (🔥).
3. Continue depressing the knob whilst holding a lighted match to the burner. For models fitted with spark ignition the procedure is similar except that burner is ignited by depressing the ignition button located on the fascia.

THETFORD MINI GRILL

4. After the burner is lit continue depressing the knob for approximately 10 - 15 seconds before releasing the knob.
5. If burner has not lit within 15 seconds, release knob and wait at least 1 minute before repeating operations (2) to (4).
6. To turn off, rotate the control knob until the line on the knob is aligned with dot on the control panel.
7. Always make sure the control knob is in the off position when you have finished grilling.

On first use of the grill, it should be heated for about 20 minutes to eliminate any residual factory lubricants that might impart unpleasant smells to the food being cooked. A non-toxic smoke may occur when using for the first time, open any windows and turn on mechanical ventilators to help remove the smoke.

Although the grill heats up quickly, it is recommended that a few minutes preheat be allowed.

It is normal for the flames on this burner to develop yellow tips as it heats up.

Depending on the food to be cooked the correct grilling height can be achieved by inverting the pan trivet into either the high or low position

⚠ WARNING:

- The grill area can get hot when the oven is in use, even if the grill is switched off.
- Care should be taken when removing pans from the grill, i.e. use of oven gloves, and by making use of the removal grill pan handle.

Note:

- The grill pan supplied is multi functional, for use in grill or oven.
- The handle design allows removal or insertion whilst the pan is in use.
- Always remove the handle when the pan is in use.
- The grill **MUST** only be used with the door open.

Maintenance

This appliance needs little maintenance other than cleaning. All parts should be cleaned using warm soapy water. Do not use abrasive cleaners, steel wool or cleansing powders. When cleaning the burner ring it is essential to ensure that the holes do not become blocked. The control knobs are a push fit and can be removed for cleaning. They are interchangeable without affecting the sense of operation.

Servicing

All servicing must be carried out by an approved competent person. Before any service work is started the appliance should have been left to cool and be disconnected from both the gas and electrical supplies. After each service the appliance must be checked for gas soundness.

For service, please contact your authorised local Service Agent giving details of the model and serial number on the databadge plus date of purchase.

Model Name & Series Number			
G30	CAT 1, 1 (28/30-37)	CAT 1, B/P(30)	THETFORD
G31	BUTANE 28-30mbar	BUTANE 30mbar	Spark Ignition
	PROPANE 37mbar	PROPANE 30mbar	Voltage ~ 50Hz
	Power kW (g/hr)	Model Number	Power kW
	Pin Number	Serial Number	QC Pass
	Country Codes 1	Country Codes 2	Order No

⚠ WARNING:

- This appliance must not be modified or adjusted unless authorized and carried out by the manufacturer or his representative. Only use parts supplied by the manufacturer on this appliance.
- If the supply cord is damaged, it must only be replaced by the manufacturer or his representative in order to avoid a hazard.

Thetford Caprice Cooker 3 burner gas hob, Grill and Oven (Sprite only)

IMPORTANT: Before using the appliances for the first time, remove all accessories and packing in the grill and oven, including any surface protection film, i.e. plastic coating. Clean all interior surfaces with hot soapy water to remove any residual protective covering of oil and rinse carefully.

WARNING:

- Accessible parts may be hot when the grill is used, young children should be kept away.
- When cooking always ensure young children are kept away.

Ensure the gas cylinder is turned on. In the event of a gas smell, turn off at the cylinder and contact supplier. The burners on this appliance have fixed aeration and no adjustment is required. Depending on the gas being used, the burners should flame as follows:

Propane - The flames should burn quietly with a blue/green colour with no sign of yellow tips.

Butane - Normally on initial lighting, as small amount of yellow tipping will occur and then slightly increases as the burner heats up.

Important: The control tap on this appliance operates both the grill and oven burners.

To ensure safe operation it is not possible to operate both burners at the same time.

Using the hob burners

1. Ensure gas cylinder/supply is connected and turned on. In the event of a gas smell turn off at gas cylinder/mains and contact supplier
2. Flame supervision: Each burner is controlled individually and is monitored by a thermocouple probe. In the event of the burner flames being accidentally extinguished, turn off the burner control and do not attempt to re-ignite the burner for at least one minute.

3. To light: Push in the control knob and turn to full rate - see Fig.2. Hold a lighted match or taper to the burner and push the control knob in and hold. It is necessary to hold the knob depressed after the burner has ignited or approximately 10-15 seconds, to allow the thermocouple probe to reach temperature, before releasing the knob. Should the flame go out when the knob is released, the procedure should be repeated holding the knob depressed for slightly longer.

4. For models fitted with spark ignition the procedure is similar except that the burner can be ignited by depressing the ignition button, which is located on the fascia. If the burner has not lit within 15 seconds the control knob should be released and the burner left for at least 1 minute before a further attempt to ignite the burner.

5. For simmering, turn the knob further anti-clockwise to the low rate position.

6. To turn off: Turn the control knob until the line on the control knob is aligned with the dot on the control panel. Always make sure the control knob is in the off position when you have finished using the hotplate burners.

Important: The two in line hob burners on this appliance will support pans from 10cm to 20cm. The single hob burner will support pans from 10cm to 22cm.

WARNING:

- Glass lids may shatter when heated. Turn off the hotplate and allow it to cool before closing the glass lid.
- Remove all spillage from the surface of the glass lid before opening.

 WARNING: The use of the electric hotplate and gas hobs will generate heat. We recommend, to avoid excess build-up of heat around the cooker area, the window is left opened when cooking to allow for additional ventilation. Care should be taken when using the oven as knobs and handle may become hot.

THETFORD CAPRICE COOKER

Using the grill

Important

- The grill must only be used with the door open.
- The heat deflector below the fascia should be pulled out prior to lighting the grill. Never adjust the heat deflector position without using hand protection i.E. Oven gloves.

1. Ensure gas cylinder/supply is connected and turned on. In the event of a gas smell turn off at gas cylinder/mains and contact supplier.
2. To light: Open door, push in the control knob and turn to full rate. Hold alighted match or taper to the burner and push the control knob in and hold. The burner should ignite and the control knob should be held in for 10-15 seconds before release. If the burner goes out, repeat procedure holding control knob for slightly longer.
3. For models fitted with spark ignition the procedure is similar except that the burner can be ignited by depressing the ignition button, which is located on the fascia. Ignition must be carried out with the door open, and if the burner has not lit within 15 seconds the control knob should be released and the grill left for at least 1 minute before a further attempt to ignite the burner.
4. On first use of the grill, it should be heated for about 20 minutes to eliminate any residual factory lubricants that might impart unpleasant smells to the food being cooked. An non-toxic smoke may occur when using for the first time so open any windows and turn on mechanical ventilators to help remove the smoke.
5. Although the grill does heat up quickly, it is recommended that a few minutes preheat be allowed.
6. Flame Failure Device (FFD): The grill burner is fitted with a flame sensing probe, which will automatically cut off the gas supply in the event of the flame going out. In the

event of the burner flames accidentally being extinguished, turn off the burner control and do not attempt to re-ignite the burner for at least one minute.

7. It is normal for the flames on this burner to develop yellow tips as it heats up, particularly on Butane.
8. A reversible grill pan trivet enables the correct grilling height to be achieved.

Fast toasting -trivet in high position

Grilling sausages -trivet in high position

Grilling steak/bacon -trivet in high position

Grilling chops, etc. - trivet in low position

Slow grilling -trivet removed

9. To turn off: Turn the control knob until the line on the control knob is aligned with the dot on the control panel. Always make sure the control knob is in the off position when you have finished grilling.

Important

- The pan supplied with the appliance is multi functional, for use either whilst grilling or when using the oven.
- The handle design allows removal or insertion whilst the pan is in use.

Using the oven

1. Ensure gas cylinder/supply is connected and turned on. In the event of a gas smell turn off at gas cylinder/mains and contact supplier.
2. To light: Open door, push in the control knob and turn to gas mark 9. Hold a lighted match or taper to the burner and push the control knob in and hold. The burner should ignite and the control knob should be held in for 10-15 seconds before release. If the burner goes out, repeat the process holding control knob for slightly longer.
3. For models fitted with spark ignition the procedure is similar except that the burner can be ignited by depressing the ignition button, which is located on the fascia. Ignition must be carried out with the door open, and if the burner has not lit within

15 seconds the control knob should be released and the oven left for at least one minute before a further attempt to ignite the burner.

4. Place the oven shelf in the required position and close the door. Set control knob to approximately gas mark 5 and heat the oven for about 30 minutes to eliminate any residual factory lubricants that might impart unpleasant smells to the meals being cooked. A non-toxic smoke may occur when using for the first time so open any windows and turn on mechanical ventilators to help remove the smoke.
5. Although the oven does heat up quickly, it is recommended that a 10 minute pre-heat should be allowed. The oven should be up to full temperature in about 15-20 minutes
6. To turn off: Turn the control knob until the line on the control knob is aligned with the dot on the control panel.
7. Shelf: The shelf has been designed to allow good circulation at the rear of the oven and are also fitted with a raised bar to prevent trays or dishes making contact with the back of the oven. To remove a shelf, pull forward until it stops, raise at front and remove.

Oven temperature control

The temperature in the oven is controlled by a thermostatic gas tap and is variable over the range 130°C to 240°C. Approximate temperatures for the settings on the control knob are shown in the table below. The temperatures indicated refer to the centre of the oven and at any particular setting the oven will be hotter at the top and cooler towards the base.

The variation between top and centre, and centre to bottom is approximately equivalent to one gas mark. Good use can be made of the temperature variation in several dishes requiring different temperatures may be cooked at the same time. In this way maximum benefit can be obtained from the gas used to heat the oven. Care should be taken not to overload the oven, adequate spacing being used to allow free circulation for heat.

Cooking guidelines

See user instructions.

Do's and Don'ts

- Do** read the user instructions carefully before using the appliance for the first time.
- Do** allow the oven to heat before using for the first time, in order to expel any smells before the introduction of food.
- Do** clean the appliance regularly.
- Do** remove spills as soon as they occur.
- Do** always use oven gloves when removing food shelves and trays from the oven.
- Do** check that controls are in the off position.
- Don't** allow children near the cooker when in use. Turn pan handles away from the front so that they cannot be caught accidentally.
- Don't** allow fats or oils to build up in the oven tray or base.
- Don't** use abrasive cleaners or powders that will scratch the surfaces of the appliance.
- Don't** under any circumstances use the oven as a space heater.
- Don't** put heavy objects onto open grill and oven doors.

Leaks

If a smell of gas becomes apparent, the supply should be turned off at the cylinder

IMMEDIATELY. Extinguish naked lights including cigarettes and pipes. Do not operate electrical switches. Open all doors and windows to disperse any gas escape.

Butane/Propane gas is heavier than air; any escaping gas will therefore collect at low level.

The strong unpleasant smell of gas will enable the general area of the leak to be detected.

THETFORD ASPIRE 2 COOKER

Check that the gas is not escaping from an unlighted appliance. Never check for leaks with a naked flame, leak investigation should be carried out using a leak detector spray.

Thetford Aspire 2 Cooker 3 Burner, Hotplate, Grill and Oven operation (Challenger & Eccles) Burner operation

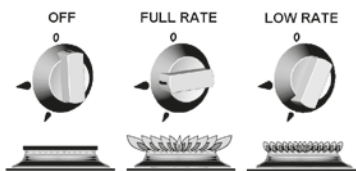

Fig. 1

Important

- Although each burner will support pans from 10 to 22cm, care should be taken not to overload the appliance as performance may be reduced.
- The following pan sizes are the maximum we recommend:- Electric Hotplate:- Ø180mm
Auxiliary Burner:- Ø200mm Semi-Rapid
Burner:- 2x Ø200mm or 1x Ø220mm with 1x Ø180mm
- When using small pans the flames should not spread beyond the base of the pan as this will reduce the efficiency of the burner.
- Avoid old or misshapen pans as these may cause instability.
- The lid must be opened fully prior to using the hotplate burners.

Using the Hotplate Gas Burners

1. Ensure gas cylinder/supply is connected and turned on. In the event of a gas smell turn off at gas cylinder/mains and contact supplier.
2. Flame supervision: Each burner is controlled individually and is monitored by a thermocouple probe. In the event of the burner flames being accidentally extinguished, turn off the burner control and

do not attempt to re-ignite the burner for at least one minute.

3. To light: Push in the control knob and turn to full rate – see Fig.1. Hold a lighted match or taper to the burner and push the control knob in and hold. It is necessary to hold the knob depressed after the burner has ignited for approximately 10 - 15 seconds, to allow the thermocouple probe to reach temperature, before releasing the knob. Should the flame go out when the knob is released, the procedure should be repeated holding the knob depressed for slightly longer.
4. For models fitted with Spark Ignition the procedure is similar except that the burner can be ignited by depressing the ignition button, which is located on the fascia. If the burner has not lit within 15 seconds the control knob should be released and the burner left for at least 1 minute before a further attempt to ignite the burner.
5. For simmering, turn the knob further anti-clockwise to the low rate position.
6. To turn off: Turn the control knob until the line on the control knob is aligned with the dot on the control panel. Always make sure the control knob is in the off position when you have finished using the hotplate burners.

Using the Electric Hotplate

Ensure the electricity is switched on.

The hotplate control is numbered from 1 to 6. To turn it on, rotate the knob either clockwise or anti-clockwise to the required position. Position 1 is the coolest setting.

To turn the hotplate off, rotate the knob until the line or pointer on the knob lines up with the zero on the control panel.

The hotplate is a sealed construction and transfers heat through conduction. For maximum efficiency a correctly sized pan with a flat heavy gauge base should be used. Pan size should be the same or slightly larger (up to 1" / 2.5cm oversize).

Before using your hotplate for the first time, we recommend that you prime and then season it.

To prime the Hotplate

Switch on the hotplate for a short period, without a pan, to harden and burn off the coating.

Use a medium to high setting for 3 – 5 minutes. A non toxic smoke may occur during this process. Allow it to cool, then season.

To season the Hotplate

First heat the hotplate for 30 seconds on a medium setting, then switch off. Pour a minimal amount of unsalted vegetable oil onto a clean dry cloth or paper towel, and apply a thin coat of oil to the hotplate surface. Wipe off any excess oil, then heat the hotplate on a medium setting for 1 minute. Occasional seasoning will help to maintain the Hotplate's appearance.

⚠ WARNING:

- Glass lids may shatter when heated. Turn off the hotplate and allow it to cool before closing the glass lid.
- Remove all spillage from the surface of the glass lid before opening.
- The glass lid has the tendency to snap shut towards the end of lowering.

This is caused by the travel lock action of the hinges as it is activated.

Make sure all fingers are removed from appliance when closing the lid.

⚠ WARNING: The use of the electric hotplate and gas hobs will generate heat. We recommend, to avoid excess build-up of heat around the cooker area, the window is left opened when cooking to allow for additional ventilation.

Important

- Depending on specification, your appliance may be fitted with a glass lid shut-off system, which cuts off the power to all hotplate burners (gas and electric) if the lid is closed.
- Ensure the glass lid is in the open and upright position before turning on the hotplate burners.

- Not all models are fitted with the shut-off system.

Operation

**WARNING
On separate oven & Grill cookers**

- The grill area can get hot when the oven is in use, even if the grill is switched off.
- Care should be taken when removing pans from the grill, i.e. use of oven gloves, and by making use of the removal grill pan handle.
- Care should be taken when using oven as knobs and handle may become hot.

Important

- The grill pan supplied is multi functional, for use in grill or oven.
- The handle design allows removal or insertion whilst the pan is in use.
- Always remove the handle when the pan is in use.
- The grill **MUST** only be used with the door open.

THETFORD ASPIRE 2 COOKER

Using the Grill

1. Ensure gas cylinder/supply is connected and turned on. In the event of a gas smell turn off at gas cylinder/mains and contact supplier.
2. To light: Open door, push in the control knob and turn to full rate – see Fig 1 (page 172). Hold a lighted match or taper to the burner and push the control knob in and hold. The burner should ignite and the control knob should be held in for 10 -15 seconds before release.

If the burner goes out, repeat procedure holding control knob for slightly longer.

3. For models fitted with Spark Ignition the procedure is similar except that the burner can be ignited by depressing the ignition button, which is located on the fascia. Ignition must be carried out with the door open, and if the burner has not lit within 15 seconds the control knob should be released and the grill left for at least 1 minute before a further attempt to ignite the burner.
4. **Note:** the grill must only be used with the door open.
5. On first use of the grill, it should be heated for about 20 minutes to eliminate any residual factory lubricants that might impart unpleasant smells to the food being cooked. A non-toxic smoke may occur when using for the first time so open any windows and turn on mechanical ventilators to help remove the smoke.
6. Although the grill does heat up quickly, a few minutes preheat is recommended.
7. Flame Failure Device (FFD): the grill burner is fitted with a flame sensing probe, which will automatically cut off the gas supply in the event of the flame going out. In the event of the burner flames being accidentally extinguished, turn off the burner control and do not attempt to re-ignite the burner for at least one minute.
8. It is normal for the flames on this burner to develop yellow tips as it heats up.

9. A reversible grill pan trivet enables the correct grilling height to be achieved.

Fast Toasting	trivet in high position
Grilling Sausages	trivet in high position
Grilling Steak/Bacon	trivet in high position
Grilling Chops, etc	trivet in low position
Slow Grilling	trivet removed

10. To turn off: turn the control knob until the line on the control knob is aligned with the dot on the control panel. Always make sure the control knob is in the off position when you have finished grilling.

Using the Oven

1. Ensure gas cylinder/supply is connected and turned on. In the event of a gas smell turn off at gas cylinder/mains and contact supplier.
2. To light: Open door, push in the control knob and turn to full rate (240°C). Hold a lighted match or taper to the burner and push the control knob in and hold. The burner should ignite and the control knob should be held in for 10 -15 seconds before release.
If the burner goes out, repeat procedure holding control knob for slightly longer.
3. For models fitted with Spark Ignition the procedure is similar except that the burner can be ignited by depressing the ignition button, which is located on the fascia. Ignition must be carried out with the door open, and if the burner has not lit within 15 seconds the control knob should be released and the oven left for at least 1 minute before a further attempt to ignite the burner.
4. Place the oven shelf in the required position and close the door. Set control knob to approximately 200°C and heat the oven for about 30 minutes to eliminate any residual factory lubricants that might impart unpleasant smells to the meals being cooked. A non-toxic smoke may occur when using for the first time so open any windows and turn on mechanical ventilators to help remove the smoke.

5. Although the oven does heat up quickly, it is recommended that a 10 minute preheat be allowed. The oven should be up to full temperature in about 15-20mins.
6. To turn off: turn the control knob until the line on the control knob is aligned with the dot on the control panel.
7. Shelf: the shelf has been designed to allow good circulation at the rear of the oven and is also fitted with a raised bar to prevent trays or dishes making contact with the back of the oven. To remove a shelf, pull forward until it stops, raise at front and remove.

Important

The pans and trays supplied with this appliance are the maximum sizes recommended for use. Larger pans and trays may restrict good circulation of heat, increasing cooking times.

Oven Temperature Control

The temperature in the oven is controlled by a thermostatic gas tap and is variable over the range 130°C to 240°C. The temperatures indicated refer to the centre of the oven and at any particular setting the oven will be hotter at the top and cooler towards the base.

The variation between top and centre, and centre to bottom is approximately equivalent to one gas mark. Good use can be made of the temperature variation in several dishes requiring different temperatures may be cooked at the same time. In this way maximum benefit can be obtained from the gas used to heat the oven. Care should be taken not to overload the oven, adequate spacing being used to allow free circulation for heat.

Operation

Cooking Guidelines

Best results will be obtained by the shelf positions in this guide. It is not necessary to preheat the oven but advisable for a range of dishes. The oven is capable of full temperature in 15-20 minutes.

Most cookery books give details of the shelf positions and gas mark settings for each recipe. If in doubt about a recipe you intend to use, study the recipe carefully then find a similar dish in our guide and use our shelf position and gas mark setting recommendation.

Shelf positions are from the top down. When roasting with aluminium foil care must be taken that the foil does not impair circulation or block the oven flue outlet.

Do's and don'ts

Do read the user instructions carefully before using the appliance for the first time.

Do allow the oven to heat before using for the first time, in order to expel any smells before the introduction of food.

Do clean the appliance regularly.

Do remove spills as soon as they occur.

Do always use oven gloves when removing food shelves and trays from the oven.

Do check that controls are in the off position when finished.

Don't allow children near the cooker when in use. Turn pan handles away from the front so that they cannot be caught accidentally.

Don't allow fats or oils to build up in the oven trays or base.

Don't use abrasive cleaners or powders that will scratch the surfaces of the appliance.

Don't under any circumstances use the oven as a space heater.

Don't put heavy objects onto open grill and oven doors.

THETFORD ASPIRE 2 COOKER

Leaks

If a smell of gas becomes apparent, the supply should be turned off at the cylinder

IMMEDIATELY. Extinguish naked lights including cigarettes and pipes. Do not operate electrical switches. Open all doors and windows to disperse any gas escape. LPG gas is heavier than air; any escaping gas will therefore collect at a low level. The strong unpleasant smell of gas will enable the general area of the leak to be detected. Check that the gas is not escaping from an unlighted appliance. Never check for leaks with a naked flame, leak investigation should be carried out using a leak detector spray.

Maintenance & servicing**Important**

- Shut off gas supply at isolating valve, switch off electric supply and ensure all parts are cool before cleaning or servicing
- All servicing must be carried out by an approved competent person.
- After each service the appliance must be checked for gas soundness
- This appliance must not be modified or adjusted unless authorised and carried out by the manufacturer or his representative. No parts other than those supplied by the manufacturer should be used on this appliance.
- If the supply cord is damaged, it must only be replaced by the manufacturer or his representative in order to avoid a hazard.

This appliance needs little maintenance other than cleaning. All parts should be cleaned using warm soapy water. Do not use abrasive cleaners, steel wool or cleansing powders.

When cleaning the burner ring it is essential to ensure that the holes do not become blocked. The control knobs are a push fit and can be removed for cleaning. They are interchangeable without affecting the sense of operation.

Dometic C600 Oven (where fitted) Conqueror, Elite, Elegance, Continental



Please read this instruction manual carefully before using the appliance.

If the appliance is given to another party, the instruction manual must also be provided.

Explanation of symbols

	WARNING Security warning: Ignoring this warning could cause serious injury or death.
	IMPORTANT! Failure to observe this note can cause material damages and affect the operation of the product.
NOTE	NOTE Additional information relative to the use of the product.
	Action This symbol indicates that action is required on your part. The required action is described step-by-step.
Fig. 1	Fig. 1 5 This information refers to an element in a figure; in this case, the figure is found in "position 5 in figure 1".

General safety instructions

The manufacturer does not assume any liability for damages in the following cases:

- Damage to the product resulting from improper use
- Changes to the product without express permission from the manufacturer
- Use for purposes other than those described in the operating manual
- Non-compliant installation and/or connections

WARNING:

- This warning is located on the appliance.
- This appliance must be installed according to the regulations in force and used only in a well ventilated area.
- Refer to the instructions before installing and using this appliance.
- The appliance must be installed by specialised technicians.

WARNING:

The appliance and its accessible components become very hot during use. Be extremely careful not to touch the heating elements. Keep children aged under 8 at a safe distance from the appliance unless they are constantly supervised. This appliance can be used by children aged 8 or over and by people with reduced physical, sensory or mental capacities or who are not familiar with the appliance or have no experience in using it, provided they are supervised or have been trained to use the appliance safely in order to understand the inherent risks. Children must not play with the appliance.

WARNING: This appliance must not be cleaned or serviced by children unless they are supervised.

DOMETIC OVENS

⚠ WARNING:

When cleaning, do not use rough abrasive materials or sharp metal scrapers to clean the glass doors of the oven as these products may scratch the surface and cause the glass to shatter. Do not use steam cleaners to clean the appliance.

⚠ WARNING:

This appliance has not been designed to operate with an external timer or with a remote control system. If the power cable is damaged, have it replaced by the manufacturer, a technical service centre or a person with similar qualifications, in order to prevent all risks.

⚠ WARNING:

Use the appliance in accordance with the intended use. Leaving a cooker unsupervised with grease or oil can be dangerous and may cause a fire. Never attempt to extinguish a fire with water; switch off the appliance and smother the flames with a towel or fire blanket.

Fire hazard: Do not keep objects on the cooking surfaces.

Intended Use**⚠ WARNING:**

This appliance can only be used to cook food. Any other use is deemed incorrect and therefore hazardous. The manufacturer declines liability for damage to property and injury to persons caused by improper, incorrect or irresponsible use.

Technical Description

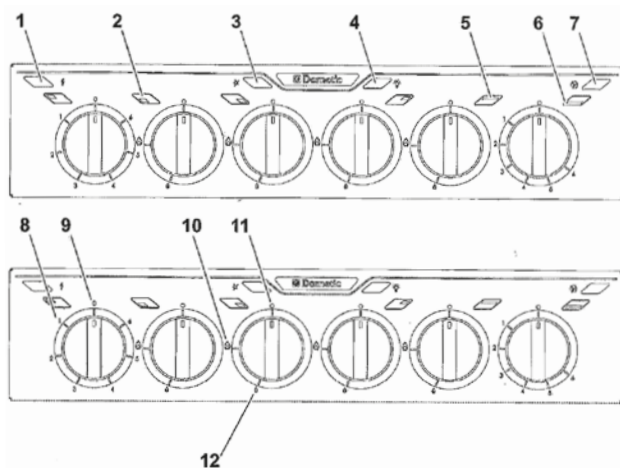











Fig 5

Control Panel

The following table shows all the buttons and symbols on the appliance.

NOTE: Buttons and symbols may vary depending on the model.

Ref	Symbol	Description
1		LED light indicating that the electric hotplate is in operation.
2		Indicates the control knob of a hob burner.
3		Button to actuate electronic ignition.
4		Button to turn on the oven light.
5		Indicates the grill control knob.
6		Indicates the oven control knob.

Ref	Symbol	Description
7		LED light indicating that the fans are on.
8	1-2-3-4-5-6	Oven or electric hotplate temperature.
9	0	Electric hotplate turned off.
10		Maximum adjustment of the flame.
11		Gas turned off.
12		Minimum adjustment of the flame.

DOMETIC OVENS

Burners

Model	Heat Output												Rated Power		
	Semrapid			Auxiliary			Grill			Oven			Electric Hotplate		
	Ø 62mm			Ø 47mm											
	No.	kW	gr/h	No.	kW	gr/h	No.	kW	gr/h	No.	kW	gr/h	No.	W	gr/h
CU601PE	2	1.8	131	1	1	73	1	1.6	116	1	2	146	1	800	200/240

Use (additional safety warning)

⚠ WARNING:

This appliance must only be used by responsible adults. The accessible parts may be hot during and immediately after use; do not touch them and keep children away. After cooking, return the knob(s) to the closed position(s). After use, close the main gas line tap.

⚠ WARNING:

This appliance may not be used by people (including children) with impaired physical and mental capacities, or with no experience in using electrical appliances, unless they are supervised and instructed by a person who is responsible for their safety.

Children must be controlled to make sure they do not play with the appliance.

The use of a gas cooking appliance leads to the generation of heat and moisture in the room in which it is installed. Make sure to provide good ventilation in the kitchen: keep natural ventilation openings open or install a mechanical ventilation device (mechanical extractor hood).

Intense and prolonged use of the appliance may require supplementary aeration such as the opening of a window or more effective ventilation such as an increase in the power of the possible mechanical extractor hood.

NOTE: When cooking food for the first time, leave the oven and the grill on at maximum capacity. The oven must be kept on for at least 30 minutes and the grill must be kept on for 15-20 minutes. Remove any liquids overflowing on the cover before opening.



This warning is clearly shown on the glass cover of the hob. The glass covers may break if heated. Ignition of any of the burners (hob, oven and grill) must always be done with the cover raised, and always turn off all the burners (hob, oven and grill) and leave them to cool down before closing the cover.



Models bearing this label on the lid have a device that only allows for gas flow when the lid is fully open.

Hob

Selecting the burner

⚠ WARNING:

The flame must not spread over the edges of the cookware. Place the cookware centrally on the burner, so that it is stable on the support grid.

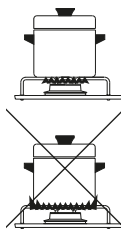

Burner	Cookware Diameter
Auxiliary Ø 47mm	from 60mm to 160mm
Semrapid Ø 62mm	from 160mm to 220mm

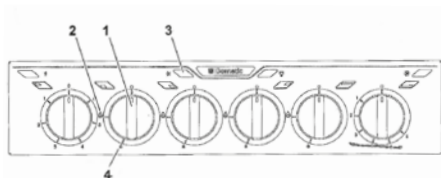

Fig 6

Electric ignition of the hob

⚠ WARNING:

Ignition must be done without any cookware or other object on the burners.

- To generate the flame, fully press down the control knob (Fig. 6 1) and turn it to the large flame position (Fig. 6 2).
- Simultaneously push down the electronic ignition button (Fig. 6 3).
- Once the flame has been generated, press the knob down for a few seconds so that the flame remains lit.

⚠ WARNING:

If the burner does not turn on:

- turn the knob to the small flame position (Fig. 6 4)
- proceed with manual ignition;
- check that there is gas in the cylinder.

If the device does not work. close the gas inlet tap and contact your dealer.

Manual ignition of the hob

If the electronic ignition does not work, the manual ignition is used as a substitute.

⚠ WARNING:

Ignition must be done without any cookware or other object on the burners.

- To generate the flame, fully press down the control knob (Fig. 6 1) and turn it to the large flame position (Fig. 6 2).
- Simultaneously ignite the burner with a match or gas lighter.

- Once the flame has been generated, press the knob down for a few seconds so that the flame remains lit.

⚠ WARNING:

If the burner does not turn on:

- check that there is gas in the cylinder.

If the device does not work, close the gas inlet tap and contact your dealer.

Regulation the hob flame

- To adjust the flame, turn the knob to the desired position (Fig. 6 1).

Oven

⚠ WARNING:

The burner must only be ignited when the door is fully open. The rack, drip pan (tray) or the pan must be positioned in the oven in a way that they are not directly in contact with the flames. If the burner flame accidentally goes out, close the gas knob and wait a minute before relighting.

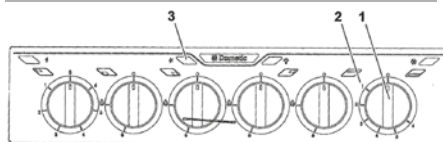

Fig 7

Electronic ignition of the oven

- To generate the flame, fully press down the control knob (Fig. 7 1) and turn it from position 1 to 6 (Fig. 7 2).
- Simultaneously push down the electronic ignition button (Fig. 7 3).
- Once the flame has been generated, press the knob down for a few seconds so that the flame remains lit.

⚠ WARNING:

If the burner does not turn on:

- proceed with manual ignition;
- check that there is gas in the cylinder.

If the device does not work, close the gas inlet tap and contact your dealer.

DOMETIC OVENS

Manual ignition of the oven

If the electronic ignition does not work, the manual ignition is used as a substitute.

- To generate the flame, fully press down the control knob (Fig. 7 1) and turn it from position 1 to 6 (Fig. 7 2).
- Simultaneously ignite the burner with a match or gas lighter.
- Once the flame has been generated, press the knob down for a few seconds so that the flame remains lit.

⚠ WARNING:

If the burner does not turn on:

- check that there is gas in the cylinder.

If the device does not work, close the gas inlet tap and contact your dealer.

Regulating the oven flame

- To adjust the flame, turn the knob to the desired position (Fig. 7 1).

Position	Temperature
1	120°C
2	150°C
3	180°C
4	200°C
5	220°C
6	240°C

NOTE: As soon as the oven burner flame is turned on, it remains at the maximum flow rate in all positions of the knob and then automatically decreases to the minimum flow rate when the set oven temperature is reached.

Grill

⚠ WARNING:

The burner must only be ignited when the door is fully open.

If the burner does not light immediately, release the knob and repeat the operation after 10 seconds.

The door must always be opened during operation.

Never use the grill for more than 25 minutes. The grill cannot be used as an oven.

If the burner flame accidentally goes out, close the gas knob and wait a minute before relighting.

Accessible parts may be hot when the grill is used, keep children away.

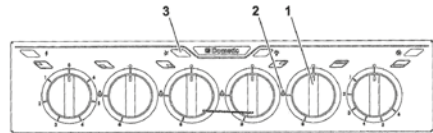

Fig 8

Electronic ignition of the grill

- To generate the flame, fully press down the control knob (Fig. 8 1) and turn it to the large flame position (Fig. 8 2).
- Simultaneously push down the electronic ignition button (Fig. 8 3). Once the flame has been generated, press the knob down for a few seconds so that the flame remains lit.

⚠ WARNING:

If the burner does not turn on:

- proceed with manual ignition;
- check that there is gas in the cylinder.

If the device does not work, close the gas inlet tap and contact your dealer.

Manual ignition of the grill

If the electronic ignition does not work, the manual ignition is used as a substitute.

- To generate the flame, fully press down the

control knob (Fig. 8 1) and turn it to the large flame position (Fig. 8 2).

- Simultaneously ignite the burner with a match or gas lighter.
- Once the flame has been generated, press the knob down for a few seconds so that the flame remains lit.

⚠ WARNING:

If the burner does not turn on:

- check that there is gas in the cylinder.

If the device does not work, close the gas inlet tap and contact your dealer.

Regulating the grill flame

- To adjust the flame, turn the knob to the desired position (Fig. 8 1).

Visual inspection of the flame

Depending on the type of gas used, the flame appears as follows:

- Propane (G31): flame with blue internal pin point and clear outline.
- Butane (G30): flame with slight yellow tips when igniting the burner; these tips intensify as the burner heats.

Electric hot plate (depending on model)

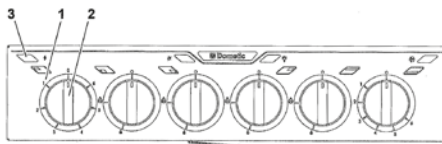

Fig 9

NOTE: When the electric hot plate is turned on for the first time, or if it has not been used for some time, the absorbed humidity must be removed by turning the plate on for 30 minutes on position 1 of the knob (Fig. 9 1). Use cookware with a flat bottom and with a diameter smaller than the diameter electric hotplate.

⚠ WARNING:

Dry the bottom of the cookware before placing it on the electric hotplate. When using the hot plate, do not leave the appliance unattended and make sure children are not nearby.

The electric hot plate is controlled by a 7-position knob (Fig. 9 2 : the off position is represented by the 0 (zero), while the positions from 1 to 6 are used to operate the electric hot plate. The scale from 1 to 6 corresponds to the increasing heat intensity generated by the electric hot plate. There is a red LED light near the knob that lights up when the electric hot plate is in operation (Fig. 9 3).

Accessories

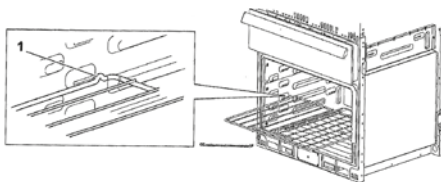

Fig 10

The rack and drip pan have a block that prevents accidental extraction (Fig.10 1). For a correct insertion, the blocks must be facing upwards and toward the inside of the appliance. To extract, slightly lift the front of the rack or the drip pan.

DOMETIC OVENS

Gas cylinders**⚠ WARNING:**

The use of gas and/or a pressure different from those indicated by the manufacturer could cause irregular and incorrect operation of the appliance. The manufacturer declines all liability for the incorrect or improper use of the appliance.

The gas cylinders to be used are the most common in the country where the appliance is used. The gas to be used is clearly indicated on the outside of the packaging and on the indelible label attached on the back of the appliance. In any case, observe the following: gas cylinders with valve and pressure reducer must be placed in an upright position and in the appropriate compartment, and access should not be impeded. Replacement of the cylinders must be performed without impediment and with ease.

Replacing the gas cylinder

- Close the taps of the appliance.
- Make sure no flames or fire are nearby.
- Close the valve of the cylinder to be replaced.
- Unscrew the pressure reducer of the empty cylinder, take it out of the compartment.
- Proceed in reverse order for replacement.
- Check for gas leaks with the use of a non-corrosive fluid.

⚠ WARNING:

- Do not use a soap and water solution.
- Do not use an open flame.

- Turn on the burners and check for proper operation, otherwise contact an authorised technician.

CLOSE THE CYLINDER GAS SUPPLY AFTER USE**Gas leaks**

We recommend using a certified electronic gas leak detector.

If you smell gas:

- open the windows and immediately get all people out of the camper, caravan etc.
- Never touch electrical switches, light matches or do anything that could ignite the gas.
- Extinguish any open flame.
- Close the cylinder valve or gas tank, and do not open the valve until the gas leak has been detected and eliminated.
- Contact an authorised technician.

Cleaning and maintenance**Cleaning the appliance****⚠ WARNING:**

Before cleaning, switch off the appliance, disconnect it from the mains power supply and wait for it to cool down.

Note: Hot surfaces could be damaged if they come into contact with cold water or a damp cloth.

Do not use abrasive, corrosive, chlorine-based products, scourers or steel wool.

Do not leave acid or alkaline substances (vinegar, salt, lemon juice, etc.) on appliance surfaces.

For stainless steel surfaces and enamelled parts: wash with soap and water or mild detergent, rinse and dry. Use clean sponges and cloths.

⚠ WARNING:

Do not use rough abrasive material or sharp metal scrapers to clean the glass oven doors as these products may cause the glass to shatter. Do not use steam cleaners to clean the appliance.

- Clean surfaces with soap and water or mild detergent, rinse and dry. In particular, remove oil residues and encrusted grease.

Removing the door

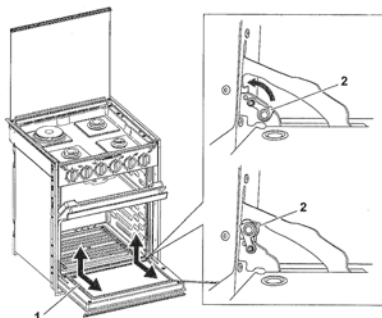

Fig 11

To facilitate cleaning, you can remove the door from the oven as follows:

- fully open the oven door (Fig. a 1).
- Position the hooks of both hinges as indicated (Fig. a 2).
- Slightly raise the front of the door (Fig. a 1) and pull it out.

To replace the door follow the procedure in reverse.

9. Failure to maintain the oven in a clean condition could lead to deterioration of the surface that could adversely affect the life of the appliance and possibly result in a hazardous situation.

Warranty

The statutory warranty period applies. If the product is defective, please contact the local manufacturer in your country (the address is on the back of the instruction manual) or your reference specialised dealer.

For repair and warranty processing, the following documents must be included when sending the appliance:

- a copy of the receipt showing the date of purchase;
- a reason for the claim or a description of the fault.

Disposal

Directive 2002/96/EC (WEEE)



Information to users

This information notice is addressed exclusively to owners of appliances accompanied by this symbol on the label bearing the technical data applied to the product (serial number label).

This symbol indicates that the product is classified, according to current regulations, as electrical or electronic equipment and complies with EU directive 2002/96/EC (WEEE).

Therefore, at the end of its useful life, it must be handled separately from household waste by delivering it, free of charge, to a recycling centre for electrical and electronic equipment or by returning it to the dealer when buying a new equivalent appliance. The user is responsible for delivering the appliance to appropriate collection facilities at the end of its working life or face the penalties provided for by current waste management legislation. A correct waste disposal of the appliance and its subsequent recycling, handling and environmentally compatible disposal helps avoid possible negative effects on the environment and health, and promotes the reuse and/or recycling of materials that make up the product. Contact your local waste disposal service or the shop where the appliance was purchased for further information regarding the collection systems available. Manufacturers and importers comply with their responsibilities for recycling, handling and environmentally compatible disposal either directly or by participating in a collective system.

MICROWAVE OVEN

Microwave oven general user instructions

Always refer to the microwave operating instructions supplied with the vehicle

Precautions to avoid possible exposure to excessive microwave energy

⚠ WARNING: Do not attempt to operate this oven with the door open since open door operation can result in harmful exposure to microwave energy. It is important not to defeat or tamper with the safety interlocks.

⚠ WARNING: Do not place any objects between the oven front face of the door or allow soil or cleaner residue to accumulate on sealing surfaces.

⚠ WARNING: If the door or door seals are damaged, the oven must not be operated until it has been repaired by a competent person (1) door broken (2) hinges and latches (broken or loosened), (3) door seals and sealing surfaces.

⚠ WARNING: It is hazardous for anyone other than a competent person to carry out a service or repair operation.

⚠ WARNING: Liquids or other foods must not be heated in sealed containers since they are liable to explode.

⚠ WARNING: Only allow children to use the oven without supervision when adequate instruction has been given so that the child is able to use the oven in a safe way and understands the hazards of improper use.

Important safety guidance

⚠ WARNING: To prevent fire, burns, electric shock and other warnings: Listed below are, as with all appliances, certain rules to follow and safeguards to assure high performance from this oven:

Important instructions

1. Do not use the oven for any reason other than food preparation, such as for drying clothes, paper, or any other non food items or for sterilizing purposes.
2. Do not use the oven when empty, this could damage the oven.
3. Do not use the oven cavity for any type of storage, such as papers, cookbook, cookware etc.
4. Do not operate the oven without the glass tray in place. Be sure it is sitting properly on the rotating base.
5. Make sure you remove caps or lids prior to cooking when you cook food sealed in bottles.
6. Do not put foreign material between the oven surface and door. It could result in excessive leakage of microwave energy.
7. Do not use recycled paper products for cooking. They may contain impurities which could cause sparks and/or fires when used during cooking.
8. Do not pop popcorn unless popped in a microwave approved popcorn popper or unless it's commercially packaged and recommended especially for microwave ovens. Microwave popped corn produces a lower yield than conventional popping; there will be a number of unpopped kernels. Do not use oil unless specified by the manufacturer.
9. Do not cook any food surrounded by a membrane, such as egg yolks, potatoes, chicken livers, etc., without first piercing them several times with a fork.
10. Do not pop popcorn longer than the manufacturer's directions. (Popping time is generally below 3 minutes). Longer cooking does not yield more popped corn it can cause scorching and fire. Also, the cooking tray can become too hot to handle or may break.
11. If smoke is observed, switch off or unplug the appliance and keep the door closed in order to stifle any flames.

12. When heating food in plastic or paper containers, keep an eye on the oven due to the possibility of ignition.
13. The contents of feeding bottles and baby food jars shall be stirred or shaken and the temperature checked before consumption, in order to avoid burns.
14. Always test the temperature of food or drink which has been heated in a microwave oven before you give it to somebody, especially to children or elderly people. This is important because things which have been heated in a microwave oven carry on getting hotter even though the microwave oven cooking has stopped.
15. Eggs in their shell and whole hard-boiled eggs should not be heated in microwave ovens since they may explode, even after microwave heating has ended.
16. Keep the waveguide cover clean at all times. Wipe the oven interior with a soft damp cloth after each use. If you leave grease or fat anywhere in the cavity it may overheat, smoke or even catch fire when next using the oven.
17. Never heat oil or fat for deep frying as you cannot control the temperature and doing so may lead to overheating and fire.
18. Liquids, such as water, coffee, or tea are able to be overheated beyond the boiling point without appearing to be boiling due to surface tension of the liquid. Visible bubbling or boiling when the container is removed from the microwave oven is not always present. This could result in very hot liquid suddenly boiling over when a spoon or other utensil is inserted into the liquid.

To reduce the risk of Injury to persons:

- a. Do not overheat the liquid.
- b. Stir the liquid both before and halfway through heating it.
- c. Do not use straight-sided containers with narrow necks.
- d. After heating, allow the container to stand in the microwave oven for a short time before removing the container
- e. Use extreme care when inserting a spoon or other utensil into the container.

Care of the microwave

1. Turn the oven off before cleaning
2. Keep the inside of the oven clean. When food spatters or spilled liquids adhere to oven walls, wipe with a damp cloth. Mild detergent may be used if the oven gets very dirty. The use of harsh detergent or abrasives is not recommended.
3. The outside oven surface should be cleaned with soap and water, rinsed and dried with a soft cloth. To prevent damage to the operating parts inside the oven, water should not be allowed to seep into the ventilation openings.
4. If the central panel becomes wet, clean with a soft dry cloth. Do not use harsh detergents or abrasives on Control Panel.
5. If steam accumulates inside or around the outside of the oven door, wipe with a soft cloth. This may occur when the microwave oven is operated under high humidity conditions and in no way indicates malfunction of the unit.
6. It is occasionally necessary to remove the glass tray for cleaning. Wash the tray in warm sudsy water or in a dishwasher.
7. The roller guide and oven cavity floor should be cleaned regular/y to avoid excessive noise. Simply wipe the bottom surface of the oven with mild detergent water or window cleaner and dry. The roller guide may be washed in mild sudsy water.
8. The oven should be cleaned regularly and any food deposits removed;
9. Failure to maintain the oven in a clean condition could lead to deterioration of the surface that could adversely affect the life of the appliance and possibly result in a hazardous situation.

CASSETTE TOILET

Thetford C260 Cassette Toilet

Quick Guide

Preparing waste holding tank

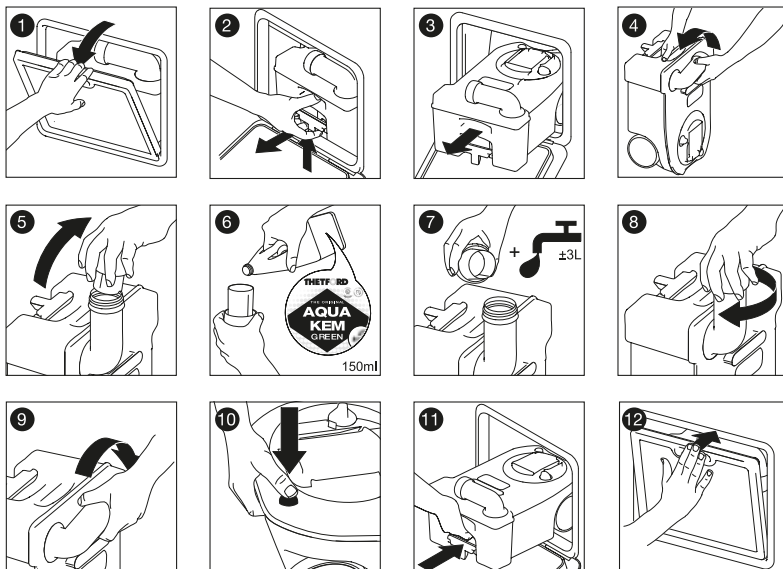

Preparing flush-water tank (only for C262-models)

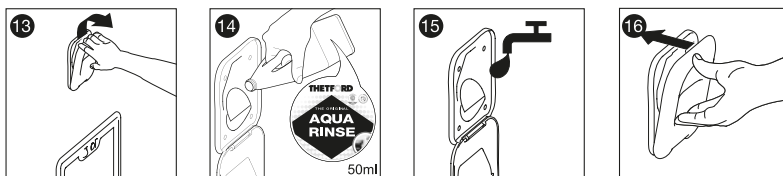

Preparing Electric Ventilator (if applicable)

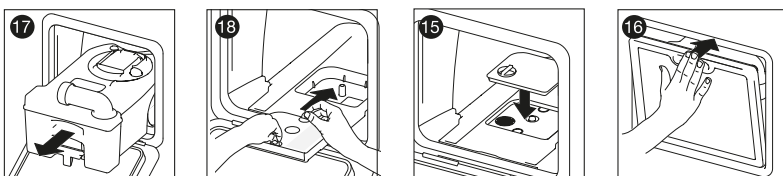

Emptying waste-holding tank

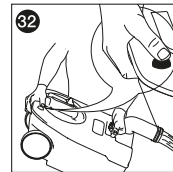
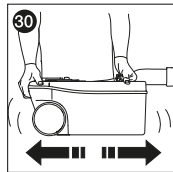
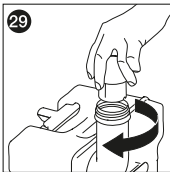
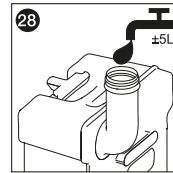
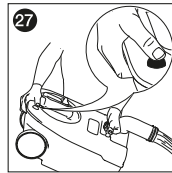
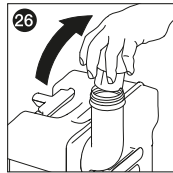
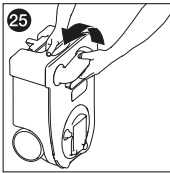
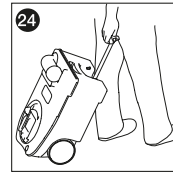
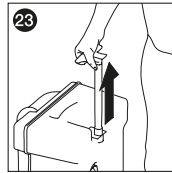
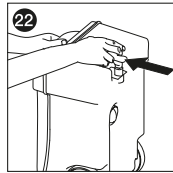
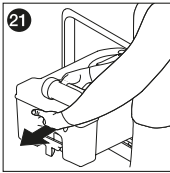

Emptying flush-water tank (only for C262-models)

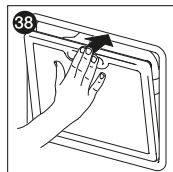
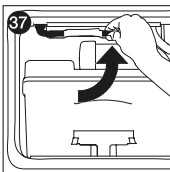
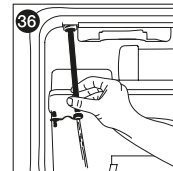
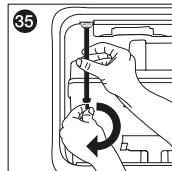
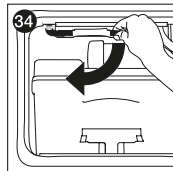
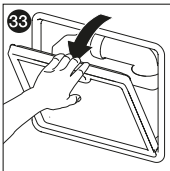

CASSETTE TOILET

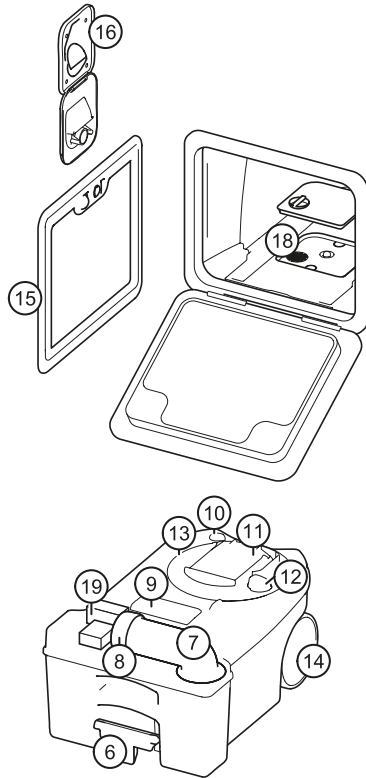
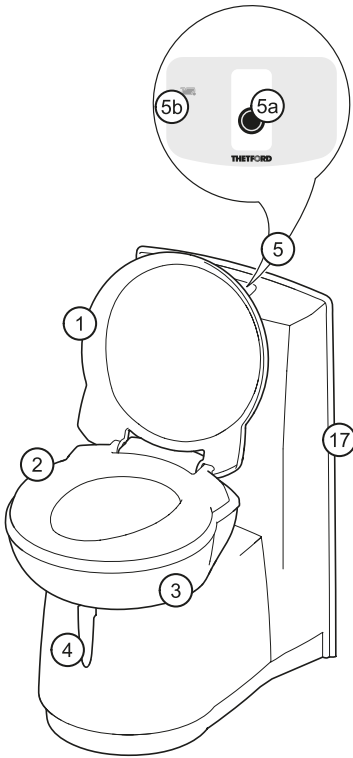

Standard

1. Cover
2. Seat
3. Swivelling toilet bowl
4. Blade handle to open/close blade
5. Control panel (position is different on C263 models)
- 5a. Flush button
- 5b. Waste holding tank level indication (1 level or 3 levels; dependent on model)
6. Pull handle
7. Pour out spout
8. Cap with measuring cup
9. Automatic pressure release vent
10. Vent button

11. Sliding cover
12. Blade opener
13. Waste holding tank mechanism
14. Wheel
15. Service door 3

Options

16. Waterfill door (only for C262 models)
17. Console with flush water tank (only for C262 models)
18. Filter for electric ventilator
19. Location waste pump out system

CASSETTE TOILET

Introduction

This Thetford Cassette Toilet is a high quality product. It is user-friendly, meets high quality standards and gives you all the convenience of home.

Before operating and using this toilet we advise you to read the manual completely. Keep this manual in a safe place for future reference.

For the latest version of the manual please visit www.thetford.eu

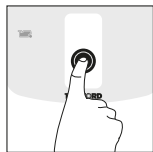
Possible toilet options

Some toilets are fitted with extra options. To check which options are available, press the flush button on the control panel.

The following symbols can light up:

- **Waste pump out system** - transfers waste from the waste holding tank into the vehicle's central waste tank.
- **Electric blade** - electrically opens or close the blade.
- **Electric ventilator** - draws unpleasant odours away from the waste tank to the outside of the vehicle.

You will find additional to these options in the grey text boxes. Thoroughly read the applicable instructions.

Preparing for use

This cassette toilet has a waste holding tank of 17.5L. A C262 model also has its own 8L flush water tank. Before using your toilet, it is vital that you add toilet additive to these tanks. Check the correct dosage on the additive package. Then add ±3L of water to the waste holding tank. Fill the flush water tank of a C262 model to the top.

Electric ventilator (if applicable)

Open the service door and remove the waste holding tank. Then remove the filter housing cover and place the new filter into the filter housing. Replace the cover and return the waste holding tank back to original position.

⚠ WARNING: Never add toilet additives directly via the blade as this could damage the lip seal of the waste holding tank. Only fill the waste holding tank via the pour out spout.

⚠ WARNING: Never use force if you cannot get the waste holding tank back into place easily. If blockage occurs, always check if the blade handle is in the closed position.

See Quick guide diagrams 1-20 for visual reference. To depressurise the waste holding tank, press the vent button before placing the tank back in its position.

Thetford offers a pleasantly scented toilet fluid for the flush water tank (Aqua Rinse) and a variety of waste holding tank products (Aqua Kem Blue, Aqua Kem Green, Aqua Kem Natural, Aqua Kem Sachets).

Aqua Rinse keeps the flush water fresh, ensures a smooth flush and leaves a protective layer. All products for the waste holding tank suppress unpleasant smells, stimulate the breakdown of waste, reduce the formation of gas, protect moving parts and help to the waste holding tank fresh and clean. For the differences between the distinguishing qualities of each waste holding tank product please visit www.thetford.eu

The range of available Toilet Care products may vary for each country.

CASSETTE TOILET

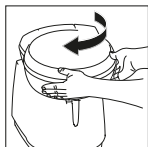
Use of your toilet**Turning the bowl**

You can turn this bowl to a desired position (max. $\pm 90^\circ$). Close the cover and use both hands to rotate the bowl as illustrated.

Opening the blade

The toilet can be used with the blade open or closed. To open the blade, slide the blade sideways as illustrated. Make sure you always close the blade completely after use.

Electric blade (if applicable)

Press the flush button to activate the control panel. Then push the Electric blade button. The blade will open or close electrically.

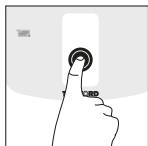
Flushing the toilet

Press the flush button once to activate the control panel. Then press the flush button for several seconds to flush the toilet.

Electric ventilator (if applicable)

By activating the control panel, the Electric ventilator start automatically. The button will flash to indicate this function is active. To stop the Electric ventilator, press the button. Press the button again to restore the Electric ventilator. To optimise its function, activate the Electric ventilator before use of your toilet.

Note: Even without an own flush water tank you can still use Aqua Rinse for a smooth and fresh lavender scented flush. Simply spray Aqua Rinse with a spray can evenly into the toilet bowl before use.

Note: Ordinary toilet paper can cause clogging. Use Aqua Soft toilet paper instead. This toilet paper is super soft, dissolves quickly, prevents clogging and makes it easier to empty the waste holding tank.

Level indication

You can check whether your waste holding tank has a 1 level or a 3 level indication. Make sure the tank is empty and place it properly. Then activate the control panel. If no level indication light lights up, your toilet has a 1 level indication. It will only indicate a full tank. If a green level indication light immediately lights up, your toilet has a 3 level indication. It will indicate empty, half full and full.

Emptying the tank**Waste holding tank**

When the red light of the level indicator on the control panel lights up, you need to empty the waste holding tank. Remove the tank via the service door. Then take it to an authorised waste disposal point. Empty the waste holding tank via the pour out spout.

Waste pump out system (if applicable)

By activating the control panel, this button automatically lights up. Press the button to empty the waste holding tank into the vehicle's central waste tank. The button flashes while the waste is being pumped and stops flashing when all waste has been transferred. ($\pm 1.5L$ of waste is left). If the central waste tank is too full (only measured when this tank has a level indicator), the button flashes rapidly and no pump out is possible until you have emptied the central waste tank.

See 'Quick guide' diagrams 21-32 for visual reference. If you want to continue using your toilet after emptying, prepare the waste holding tank again.

CASSETTE TOILET

Note: Our 'green' products Aqua Kem Green, Aqua Kem Natural and Aqua Rinse (test ISO 11734) are absolutely safe to empty into a septic tank or small biological systems on camping sites.

⚠ WARNING: Please avoid travel with a waste holding tank that is more than 3/4 full. This may cause leakage through the venting system.

Flush water tank (only for C262 models)

The flush water tank has a capacity of 8L. Only empty the flush water tank completely if you don't expect to use your toilet for a long (winter) period. Place a sufficiently large bowl under the drain tube and catch the remaining water. Empty this bowl at an authorised waste disposal point.

See 'Quick guide' diagrams 33-38 for visual reference.

⚠ WARNING: To prevent water damage to your caravan, ensure you don't travel with a full flush water tank or with water in the bowl.

Cleaning

Just like your toilet at home, it is also important to clean this cassette toilet regularly. You will prevent limescale and ensure optimal hygiene. Clean the inside of the bowl with toilet bowl cleaner and a soft brush and use bathroom cleaner for the outside of the toilet.

⚠ WARNING: Never use the household cleaners to clean your toilet. These may cause permanent damage to the seals and other toilet components.

Waste pump out system (if applicable)

Fill the emptied waste holding tank with water and place the tank back. Then activate the control panel. Press the waste pump out system button to pump the water through the system. Do this once every 3 weeks.

Remove seat and cover

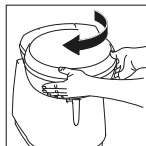

To clean your toilet thoroughly, remove the seat and cover. First push the seat and cover together to the right then lift them up.

Winter use

You can use your toilet as normal in cold weather as long as the toilet is situated in a heated location. If this is not the case, and there is a risk of frost, we advise not to use your toilet. Make sure you completely empty the waste holding tank. For a C262 model also empty the flush water tank.

Note: Aqua Kem Sachets are particularly suitable for winter camping as the sachets are filled with powder. They completely dissolve in water, are easy to dose and economical in use.

Maintenance

To prolong the life span of your toilet, maintain your toilet regularly. Use cassette tank cleaner 2 to 3 times a year on the waste holding tank.

It safely removes stubborn limescale on the inside of the tank. When seals become dry, use seal lubricant to keep the seals soft and pliable. It has been specially developed for mobile toilets and is absolutely safe to use.

⚠ WARNING: Never use Vaseline or vegetable oil to lubricate the seals as these may cause leakage to your waste holding tank.

Waste pump out system (if applicable)

To ensure optimal functionality, maintain the waste holding tank regularly. Fill the waste holding tank with water and rinse it. Then use Cassette Tank Cleaner. Do this every 6 weeks when on holiday.

CASSETTE TOILET

Electric Ventilator (if applicable)

After approximately 4 weeks of use, the filter loses its absorption power. Remove the filter housing cover and place the new filter into the new housing.

Storage

If you don't expect to use your toilet for a long period, you have to thoroughly empty, clean and dry the whole toilet. Also empty the flush water tank of a C262 model. This is also a good moment to maintain your toilet. During storage we advise leaving the blade open to prevent damage to the blade and to loosen the cap of the pour out spout to ventilate the waste holding tank.

Electric ventilator (if applicable)

Remove the filter of the filter housing.

Disposal

Your product has been designed and manufactured with high quality material and components, which can be recycled and reused. When your toilet has reached the end of its life, dispose of the product according to the local rules. Do not use the toilet with the normal household waste. The correct disposal of your old product will help prevent potential negative consequences for the environment and human health.

Questions?

If you require further information or have any questions about your toilet, please visit our website www.thetford.eu If you still have questions, contact the Customer Service Department in your country or your holiday location.

For correct and efficient support, please ensure all relevant product type information is available.

Spare parts

Original Thetford spare parts are available through your own dealer or an authorised Thetford Service Centre.

FAQs

What should I do in case of a defect on my Thetford toilet? Contact your dealer where you bought your vehicle, or if you are on holiday, contact an authorised Thetford Service Centre.

A red light on the control panel flashes, what should I do? Check if the waste holding tank is present or positioned properly.

I cannot move my waste holding tank. Check if the blade of your toilet is completely closed.

What should I do when the electric blade doesn't function? Manually open or close the blade by sliding the small handle under the toilet bowl sideways.

What should I do if the blade is blocked? Loosen the cap with measuring cap from the pour out spout and try again.

Does the toilet have a fuse? Yes, the toilet has a maintenance free self-resetting fuse.

Warranty

Thetford BV offers the end users of its products a three-year guarantee. In the case of malfunction within the warranty period, Thetford will replace or repair the product at its discretion. In this case, the costs of replacement, labour costs for the replacement of defective components and/or the costs of the parts themselves will be paid by Thetford.

1. To make a claim under this guarantee, the user must take the product to his dealer or an authorised Thetford Service Centre (www.thetford.eu). The claim will be assessed there.

BARBEQUE POINT

2. Components replaced during repair under guarantee become the property of Thetford.
3. This warranty does not prejudice current consumer protection laws.
4. This warranty is not valid in the case of products that are for, or are used for, commercial purposes.

Guarantee claims falling into one of the following categories will not be accepted:

- the product has been improperly used or the instructions in the manual have been followed (for example incorrect use of additives;
 - alterations have been made to the product;
 - the product has been repaired by an unauthorised Thetford Service Centre;
 - the product code or serial ID has been changed;
 - the product has been damaged by circumstances outside the normal use of the product.
5. Not using Thetford products to care for your Thetford toilet could create some damage, which would not be covered by this warranty.

Thetford is not liable for any loss and/or damage caused directly or indirectly by use of the toilet.

Caravans with external barbecue point (when fitted)

Models equipped with an external barbecue point can be used to power any gas appliance suitable for the gas used in the caravan, at the working pressure shown on the label in the barbecue outlet box. Please note when using the outlet that the fitted regulator will allow a maximum of 1.5kg per hour of gas to be taken from the gas bottle. Therefore the consumption of gas from both the appliances within the caravan and the appliance connected to the barbecue point cannot exceed a total of 1.5kg per hour at any one time. If you are in any doubt please consult your dealer for advice. To use point proceed as follows:

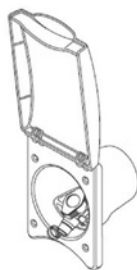

19

20

When external gas equipment is being connected, the operating pressure of the gas supply of 30 or 50 mbar must correspond with the operating pressure of the equipment that is being connected (see data plate).

The plug-in connection can only be made if the quick acting valve is closed. The safety locking mechanism can be released by sliding back the coupling sleeve.

EXTERNAL SHOWER POINT

The coupling K-valve is designed such that the quick acting valve can only be opened if the connection has been made via the plug-in connection. The connection is made by inserting the plug-in connection into the safety coupling.

This operation can be carried out using one hand. After uncoupling the equipment, seal off the valve opening using the protection seal.

Note: The external gas socket is only suitable for removing gas, not for feeding gas into the gas system.

⚠ WARNING: Care should be taken when using the external barbeque point. Never barbeque next to an awning or tent.

⚠ WARNING: The caravan barbeque point should only be used as an outlet point for gas, never connect a gas bottle direct to the outlet.



External shower point (when fitted)

The external shower point, is supplied with a separate shower head and hose assembly. To connect the shower, simply align the plug with the socket and push into position. To remove, pull the lower trigger and pull the plug from the socket.



Caravans with TV inlet in battery box (when fitted)

Models equipped with TV points in the battery box have the facility to take an external signal and supply that signal to TV points within the caravan.

Caravans equipped in this way feature a direct link from the connection point in the battery box, to an auxiliary connection point at the primary TV position within the caravan.

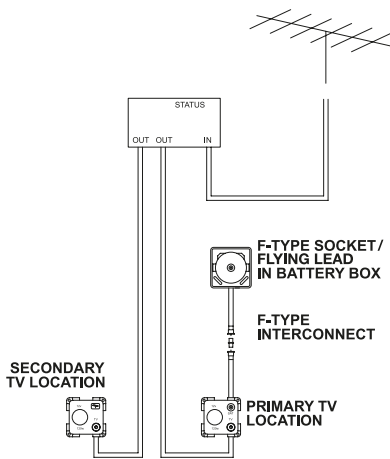

The direct link can be used to:

1. Supply an external signal (caravan site TV feed) to the primary TV position
 - a. Connect the socket in the battery box (on flying lead depending on model), with a suitable lead, to the appropriate socket on the caravan site supply post. As the connector in the battery box is a screw on 'F-type' connector, an adaptor to convert this to a 'push-on' co-ax connector, which may be required, has been supplied with your caravan.
 - b. Locate the primary TV position within the caravan. At the 12V, TV and SAT socket, connect your TV to the output from the socket marked SAT with a suitable lead.
2. Connect an external satellite dish to a decoder within the caravan. (The direct link uses F-type interconnects throughout to

allow the decoder and dish to communicate correctly)

- a. Connect the dish to the socket (or flying lead) in the battery box with a suitable lead. The F-type to co-ax adaptor should not be used.
 - b. Connect the dish input connection on the decoder to the 'SAT' socket on the 12V, TV and SAT socket located in the primary TV location.
3. Supply a signal from within the caravan to the exterior of the caravan
 - a. Connect the output from your VCR, DVD player or other device to the SAT connection on the 12V, TV and SAT socket at the primary TV position.
 - b. Connect your receiving device (TV or similar) to the socket in the battery box with a suitable lead.

As can be seen from the simplified schematic, when multiple TV locations are present in a van, all of these receive signals from the TV aerial connection box. Using adaptors and link cables which are readily available, it may be possible to re-direct a signal from the 'SAT' connection at the primary TV location, up to the aerial connection box to be then distributed to other TV positions within the caravan. Please remember that as the number of connections increases the quality of the signal reduces.

Supplier fitted / supplied entertainment equipment

Audio-visual equipment may have been fitted by your dealer, or supplied with the caravan, depending on the specification of the caravan. Although not specific, below are details of the types of equipment which would be fitted as appropriate to the specification of the caravan:

CD/MP3/TUNER WITH AUXILIARY INPUT

Provision has been made in the furniture for your dealer to install a provided head unit similar in appearance to that fitted in the dashboard of a car. The unit operates as a CD player and FM/AM radio. In addition MP3 files stored on a CD can be read and played by the unit. Speakers mounted in the front locker of the caravan are connected to this head unit for a stereo sound output. Connecting the head unit to the roof mounted status or Shakespeare aerial allows reception of radio stations.

An auxiliary input on the front of the unit allows a separate MP3 player or similar to be connected from that player's headphone socket. This can be positioned in the locker and connected directly to the front of the head unit, using an appropriate lead (not supplied), or alternatively where fitted, can be connected at a socket on the binnacle at the front of the caravan, again using an appropriate lead.

(Conqueror/Elite/Elegance/Continental)

To use the connection on the binnacle, plug the flying lead found in the locker below the head unit, into the 'Aux In' socket on the front of that head unit. At the binnacle, locate the 3.5mm jack socket near the centre of the binnacle. Using an appropriate lead, (not supplied) connect your player's headphone socket to the jack socket on the binnacle, to relay sound up to the head unit. Depending on the specification of the head unit, 'Aux in' may need to be selected as an audio source on the head unit, and the volume levels of both the head unit and the player may have to be adjusted to find an appropriate sound level.

Shakespeare TV Omni-directional Antenna (Sprite)

The circular, roof mounted Shakespeare antenna is designed for analogue and digital TV reception. All of the connections are pre-made to the antenna, up to the TV sockets mounted on the furniture within your caravan. The aerial is omni-directional so no external

adjustment is required- the aerial connection box, however, does feature a gain control. Rotate the control clockwise to increase gain, and anti-clockwise to reduce gain, to optimise reception.

STATUS DIRECTIONAL TV AND FM RADIO ANTENNA

(Eccles, Challenger, Conqueror, Elite, Elegance, Continental)

Firstly determine the approximate location of the nearest transmitter and whether the signals are horizontally or vertically polarized. For assistance ask your site operator or check antennas in the vicinity

1. Loosen the Mast Locking Collar and Wall Bracket and raise the antenna. Turn the mast to direct the Antenna towards the TV transmitter.

The RED spot on the bottom of the mast indicates the front of the Antenna.

2. When receiving vertically polarized signals, rotate the winder anti-clockwise to cant the antenna through 90°. The red / green indicator, if present, indicates vertical or horizontal orientation.

Note: Direction assumes user is looking down on roof.

Note: DO NOT over tighten or use undue force on the winder.

3. Switch ON the Power Pack and the RED LED will illuminate.
4. Check the gain control switch is set to normal – NML.
5. Tune your television to the strongest signal. You may need to adjust the direction of the mast to achieve the best quality picture.
6. Secure by tightening the Mast Locking Collar and Wall Bracket

Removing the antenna

A permanently fitted Status can be easily removed leaving only the Mounting Foot and rubber gaiter.

1. Unplug the antenna from the Power Pack.
2. Loosen the Mast Locking Collar and Wall Bracket and lift off whilst feeding out the cable.
3. Push the Blanking Cap supplied into place.

⚠ WARNING: The Blanking Cap is a temporary seal and is not for long term use.

⚠ WARNING: Always ensure the aerial is lowered before driving off.

Caravans with external entertainment point (when fitted)



An external service door positioned on the door side of the caravan houses the connection points and an extended vesa bracket to mount a TV for viewing inside the awning. This comprises 230v & 12v sockets, aerial points and the TV bracket.

The maximum weight of the TV should not exceed 4.5kg, this is intended for use in-conjunction with an awning to provide weather protection for the TV and its connections.

Note: A TV should never be mounted and connected to the mains supply outside an awning.

It is also important to ensure cables and equipment are maintained in good condition and simple checks are made every time you use it ensuring cables are retained to prevent the potential for trip hazards.

Bedding configurations

Sleeping bags and duvets can be compressed into small spaces and can be ready to use in minutes.



Fig. A



Fig. B

Lower single beds assembly (Figs. A & B)

1. Lower dinette table and place between the recess in both seats.
2. Arrange seat cushions as appropriate.

Double bed assembly (Fig. C)

1. Grip front of slatted bed and walk backwards until bed is fully extended.
2. Arrange seat cushions as appropriate.

BEDDING



Fig. C

Lift-up bunks

1. Grasp the bunk and pull carefully upwards and towards you. **(Fig. D)**
2. The bunk is designed to automatically move into the correct position. **(Fig. E)**
3. Where a bed board is fitted, unfold and make sure it is secured by press studs when lifted into position. (The bed board is required to protect both the occupant and the window from damage during use of the bunk.) **(Fig. F)**
4. Locate safety boards. **(Fig. G)**
5. Arrange seat cushions as appropriate. **(Fig. G)**

Bunks are designed to carry a child to a maximum of 70kg (11 stone)

⚠ WARNING: use the upper bunks for sleeping only, with the provided protection against fall out in position.

⚠ WARNING: Care shall be taken against the risk of fall out when the upper bunks are in use by children especially under 6 years of age, these bunks are not suitable for use by infants without supervision.

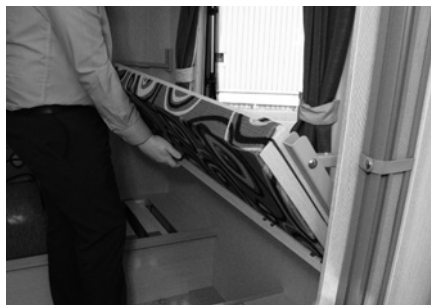

Doorscreen

The door flyscreen is tracked top and bottom and operation must be by the centre of the handle to aide a smooth operation.

The door flynet operates independently of the door by sliding across the door threshold.

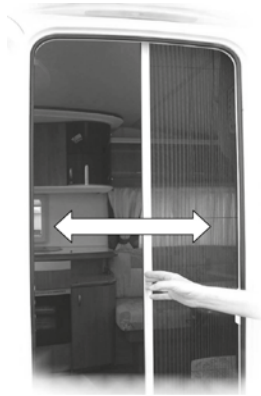

The door blind (when fitted) slides vertically within the door cassette.



⚠ WARNING: When opening or releasing the doorscreen, care must be taken to avoid trapping fingers.

Exterior Door Key

⚠ WARNING: Care should be taken not to leave the exterior door key in the door when unlocking the door. The key may result in damage in the vehicle side if the door is released with the key still in the lock.

⚠ WARNING: The door retainer is designed to hold the door in normal conditions. In gusty or windy conditions we recommend the door is closed to prevent it releasing and slamming shut.

Exterior door Operation: Sprite Freedom, Sprite, Challenger, Eccles

The door is locked from the inside by rotating the outer handle vertically.

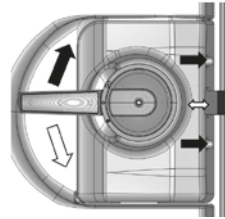

Exterior Door Operation: Conqueror, Elite, Elegance, Continental

To un-lock the door, insert the key and turn clockwise ensuring the key is removed before the door is opened to prevent damage to the caravan side.



WINDOWS/ ROLLER BLINDS

There are 3 primary positions for the internal handle inside the caravan, these are locked, neutral and open. When closing the door from inside or outside the caravan ensure the handle is in the neutral position. The handle **MUST NOT** be partially up in the locked position as this will prevent the door from closing causing damage to the door, or if slammed shut, lock the door from inside.

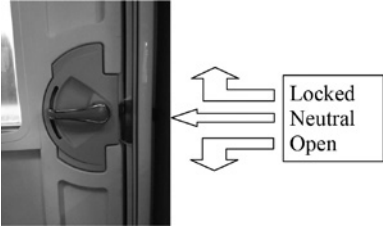

The door blind slides vertically within the door cassette.

⚠ WARNING: The door retainer is designed to hold the door in normal conditions. In gusty or windy conditions we recommend the door is closed to prevent it releasing and slamming shut.

Windows

To open all window types turn the internal handles through 90 degrees and push open the window.

Windows / Roller Blind Advice

In case of prolonged exposure to the sun roller blinds should not be completely closed as this could cause excessive heat concentration at the top of the window, due to characteristics of the glazing material the windows could be adversely affected.

Roller blinds that shade from the bottom upwards it is necessary to leave a gap of a few centimetres open at the top, this way the heat between window and blind can escape. A fly screen does not cause an obstruction.

Roller blinds that shade from the top downwards must be kept completely open, or be opened regularly to allow the heat to escape.

Keeping the windows in ventilation position allows heat to escape.

Never fully close a roller blind system when storing the vehicle or when not in use for longer periods!

Therefore for optimal window life it is recommended:-

- Blinds starting at the bottom of the window a gap should be provided for ventilation at the top with the window in its ventilation position.
- For vehicles containing blinds from the top downwards or with other types of reflective blinds / curtains, please make sure that these blinds are also ventilated or not fully closed.

Ensure that all windows and roof vents are closed when the vehicle travels on the road.

Heki care instructions

Clean the blind only with a damp sponge.
Clean on a regular basis to avoid dust/ dirt particle build up as this can damage the blind material. Use only water or with mild suds or a vacuum cleaner.

In order to avoid material fatigue, do not leave the flynet closed for a long time.

- Clean the dome with the Seitz Acrylic Cleaner.
- Opaque spots and light scratches on the dome can be removed with the Seitz Acrylic Polish and the Seitz Special Polishing cloth.
- Use talcum powder regularly (4 times yearly) to care for the rubber seals supplied with versions without permanent ventilation.
- Clean the blinds only with water and mild soap suds.

Safety precautions:

- Repairs should be carried out only by trained personnel.
- Inform an approved dealer in case of defects and malfunctions.
- Before starting off, check the rooflight for damage in the dome (tension cracks) and the opening mechanism which could arise owing to, for example, branches and other natural causes.
- Do not step on the dome.
- Close the rooflight before starting off (check whether it is locked).
- Do not leave the vehicle with the rooflight open (danger of burglary).
- Do not open in strong wind or rain.
- Before opening the dome remove snow, ice, dirt etc. from the dome.
- Malfunctions are to be repaired by an approved dealer at once.
- Do not use caustic detergents (danger of tension cracks in the dome).
- Before setting off close the dome, check the locking mechanism and open the blinds.

The guarantee becomes null and void if the care and safety instructions are not followed.

Mini Heki rooflight (when fitted)



To open depress the button (**Fig. A**).



Pull the bar down and forwards (**Fig. B**).



By pushing the bar in to the marked rest positions (**Fig. C**).

ROOFLIGHTS

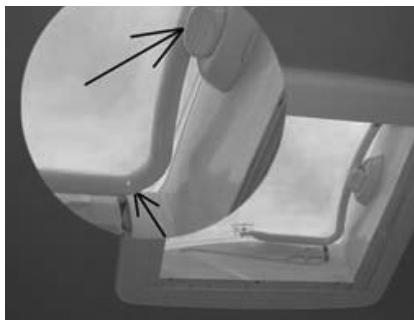

Two extra opening angles apart from the one in which the dome is fully opened can be chosen. The intermediate position can be fixed with a slide marked with the arrows. Care should be taken to ensure the dome is closed and locked for transit with the bar located behind the locking button (**Fig. D**).

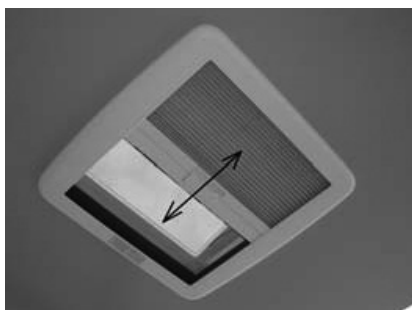

The blind flynet operate together and engage via the clips in the bar, then slide to gain the desired blackout or ventilation (**Fig. E**).

Midi-Heki rooflight

Opening the Dome

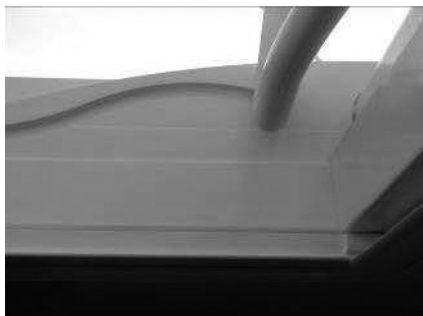

Intermediate position for the dome

By pushing the bar into the marked rest position, two extra opening angles, apart from the one in which the dome is fully opened, can be chosen.



Closing the Dome

(drive and rest position)

Push the bar with both hands on the right and the left side in such a way that the hook bolt (1) the dome on the left and the right side and the bar lies on the push button (2). Check if the dome is locked.

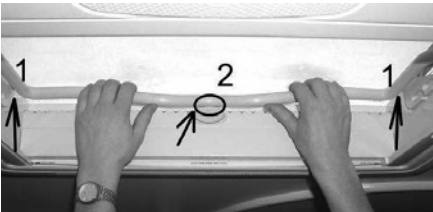

1



2



⚠ WARNING: The retaining catches are designed to hold the skylight open to the selected position. In gusty or windy conditions the Skylight should be closed to prevent it from being blown fully open or slamming shut.

Heki-2 roof light (when fitted)

The lift/tilt roof light can be set in 3 positions by means of pneumatic springs.

Position 1 lifts the pane 12mm without allowing rain to enter the caravan.

Position 2 sets the pane to a 150mm opening and locks with a bar.

Position 3 opens the pane through 55°.

A fully adjustable flyscreen and black-out screen are built into the inner frame. The flyscreen can be drawn independently and the black-out screen is variable for partial or full black-out.

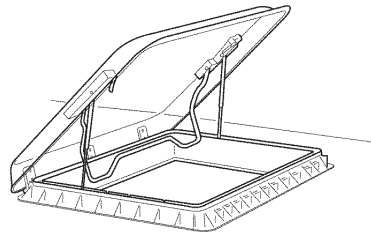

Forced ventilation functions via a brush lined duct instead of a ventilated pane.

A cover hood can be fitted for winter protection.

Heki-2 roof lights provide 13,200mm² of fixed ventilation.

ROOFLIGHTS

Heki 4 Remote Control (when fitted)

The remote control is ready for use after inserting the two batteries and functions within a maximum distance of 1.5m from the Heki rooflight sensor located near the red control lamp on the forward edge of the inner frame. When the power is turned on for the first time or after an interruption in the power supply, the red control lamp will blink. Hold the remote close to the control lamp and press any of the buttons to turn the control lamp off. The light will remain illuminated if the rooflight is not completely closed.



Opening/closing the acrylic dome

Hold the remote control in the direction of the red control lamp. Press button 1 temporarily and the dome will open to 70 degrees. To stop the dome fully opening press button 1 again before it reaches 70 degrees.

Press and hold button 2 to close the roof

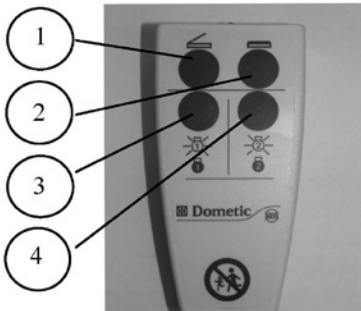

1 = open roof 2 = close roof
3 = light 1 on/off 4 = light 2 on/off

Lighting (optional)

Buttons 3 and 4 operate the optional lights.

Rain Sensor

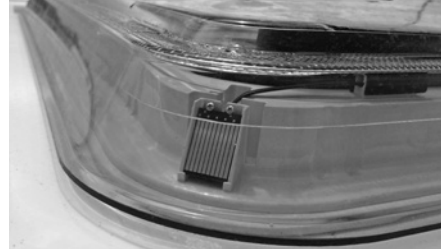

The Heki 4 rooflight is equipped with an automatic rain sensor which will completely close the dome should moisture be detected. Should you wish to keep the dome open simply press either the opening or closing button to stop it closing.

WARNING:

- Do not operate the control when there are persons near the Heki rooflight.
- Do not stop in the vicinity of the open dome.
- Do not lean out or climb through the open dome. The dome may close automatically if you make contact with the rain sensor or if moisture, (fog, rain, condensation) is present
- Before travelling ensure that the dome is fully closed and the blinds open.

Blinds

A fully adjustable flyscreen and black-out screen are built into the inner frame. The fly screen can be drawn independently and the black-out screen is variable for partial or full black-out.



⚠️ EMERGENCY PROCEDURE

In event of power failure the dome can be closed manually as follows:

- Switch off the power supply from the vehicle to the HEKI
- Remove the ventilation grilles and the covers for the lights.
- Disconnect the 12V plug and power supply from the vehicle.
- Remove the screws from the inner frame and pull down the inner frame.
- Remove the emergency crank from its housing, insert it in the octagonal shaft (See photo) of the driving mechanism and turn. Please note - once the acrylic dome is closed turn the crank a further 2-3 complete turns to lock the dome in position.
- Check whether the rooflight is completely closed (push the acrylic dome upwards with your hand to see if there is any movement).



Octagonal Shaft

MPK Rooflight (when fitted)**⚠️ WARNING:**

Never stand on the dome of the rooflight!

**Instruction for use**

The rooflight can be opened fully, or in four different directions, so that the dome can be angled against weather conditions.

To raise, squeeze the handle together to release from the lock.

Free-air-flow

⚠️ WARNING: When closed there is a free airflow through the rooflight, which must be kept free at all times.

When driving**IMPORTANT:**

All rooflights must be locked down before travelling and both roller blinds locked in the fully open position against the frame.

ROOFLIGHTS

Care instructions:

The rooflight should only be washed by hand, using a sponge with plenty of clean water to avoid scratching. Caustic detergents and solvents may attack the plastic and make it brittle or disintegrate.

For easier cleaning of the dome it can be removed from the frame by releasing the four screws holding the handle arms. Do this from the inside of the van.

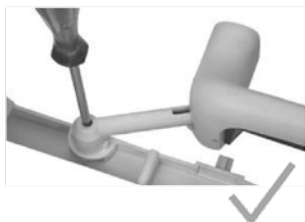

Lift the dome clear of the roof and rotate so that it can be lowered into the van across the diagonal of the aperture.

Make sure that only the original screws are used when replacing the dome and that they enter the thread in the plastic correctly. Do not over-tighten.

Never remove the screws holding the dome and the handles together. These are secured by a torque screwdriver and should only be handled by an approved dealer.

Safety precautions:

- repairs should be carried out only by trained personnel
- inform an approved dealer in case of defects and malfunctions
- before starting off, check the rooflight for damage in the acrylic dome (tension cracks) and the opening mechanism which could arise owing to, for example, branches and other natural causes.
- do not step on the acrylic dome
- close the rooflight before starting off (check whether it is locked)
- do not leave the vehicle with the rooflight open (danger of burglary)
- do not open in strong wind or rain
- before opening, remove snow, ice, dirt, etc. from the acrylic dome
- malfunctions are to be repaired by an approved dealer at once
- do not use caustic detergents (danger of tension cracks in the acrylic dome)
- before setting off close the acrylic dome and open the blinds
- function of the ventilation (optional) is only ensured if the space between roof and glazing dome is free of dirt and snow.

Care instructions:

- clean the acrylic dome with the Seitz acrylic cleaner
- opaque spots and light scratches on the acrylic dome can be removed with the Seitz Acrylic Polish and the Seitz Special Polishing cloth:
- Use talcum powder regularly (4 times yearly) to care for the rubber seals
- clean the blinds only with water and mild soap suds

The guarantee becomes null and void if the care and safety instructions are not followed.

Care of laminate tops, tables, furniture and doors

Do not use abrasives, chemically treated cloths or aggressive detergents as these may cause damage.

Do not place hot objects on laminated surfaces i.e. tops, tables. Any temperatures 70°C and over may cause permanent damage.

Clean worktop surfaces, furniture and door fascias with a soft, slightly damp cloth, dry off with a soft cloth.

Doors

In order to provide customers with the latest designs of door furniture it is possible, due to the use of natural wood, that warping may occur. This should not detract from the correct functioning of items fitted in the caravan.

Information

During the normal travelling vehicle vibration and flexing may cause some of the furniture doors to become out of alignment.

For your convenience many hinges are adjustable.

Tables

Slide the top of the chest of drawers forward to form a convenient table. Lift the rear portion to slide the top away. (Fig. A)



⚠ WARNING: When erecting the free standing table, be careful to avoid trapping fingers.

Table storage

To avoid damage care must be taken when removing tables from their stored position.

Where two tables are stored together in a low level storage area care should be taken to remove the table positioned opposite the hinged edge first.

SHOWER / AWNING / SUNROOF / ROOF

Tables stored in the table storage compartment must be securely clipped into place whilst in transit.

Shower care points

- Care should be taken as water may become hot temporarily when switched on until it mixes and regulates.
- Small children should be supervised at all times when using the shower.
- We recommend unfastening the shower head before travelling and storing safely to prevent it becoming detached whilst towing.

Fixing of awnings

In order to avoid puncturing the outer skin of the caravan wall, it is recommended that awning poles are fixed to your caravan using load spreading eyelet pads or rubber sucker pads.

Attaching awning brackets and associated fixings to your caravan by using mechanical methods which pierce the outer skin of the caravan wall can allow water ingress which will invalidate the product warranty.

Important:

Care must be taken when using an awning as poles and suckers can cause damage to exterior side panels.

Awnings should be taken down in strong winds to protect the side panels from cosmetic damage and dents from the awning poles.

Note: Awnings should be kept ventilated when discharging products of combustion exhaust into them.

Awning Sizes

Due to the various awning types and sizes the awning sizes provided in the Service and Warranty Handbook are for guidance only.

Full details and sizes of awnings (A-A dimensions) for your caravan can be found in your Technical Handbook.

Specific awning sizes must be confirmed with the dealer or awning manufacturer prior to purchase.

TV Brackets (when fitted)

In some models a bulkhead mounted bracket is supplied to mount a TV on. Whilst the bracket has a secure travel lock, it is good practise to un-clip the TV from the bracket and store securely for transit.

Colour reference

If a customer requires touch-up paint or a respray of a caravan, the correct colour code for all white components is Fiat White 249.

Please be aware that colours can fade over time, and therefore, if the vehicle is more than a few years old, it is suggested a colour match be obtained.

Front locker and sunroof

The front locker is made from ABS thermoformed plastics, which are easy clean textured surfaces. To ensure long life and prevent damage you must not use any cleaning materials including solvents or aggressive cleaning materials. We recommend the use of warm soapy water, applied with a damp cloth.

Where a front sunroof is fitted, directly above the front windows, it is recommended that the blind be left open during use (or storage) in high temperatures or direct sunlight, to avoid a build-up of heat within this non-opening window.

Bonded Roof

The roof of your caravan is made from a bonded construction. Care should be taken when cleaning the roof not to walk directly on the roof. If access to the roof is required the weight of a person should be spread across a larger area using a spreader board and extreme care should be taken when working at heights.

Step on hitch cover

Where a step on hitch cover is fitted, customers are reminded only to stand on the designated areas, identified with black anti-slip matting. Stepping elsewhere on the hitch cover may result in damage to the hitch cover.

Models without a step on hitch cover are not suitable for standing on and failure to follow these simple instructions may result in premature failure or cracking which will not be covered by any guarantees (including extended warranties).

Cycle racks

The Swift Group allows the fitment of two cycle rack carrier and we have made provision for this with two pre positioned mounting rails fitted to the rear of your caravan. These are spaced at either 800mm or 850mm apart. Below are the racks which can be purchased from Thule, which are compatible with the pre-fitted rails.

Thule Bike carriers

The Swift Group only recommends a Thule cycle carrier which will conveniently clip in to the pre-installed mounting rail. The maximum weight which can be mounted on the carrier is 50kg.



Note: Care should be taken to balance the load when bikes are carried on the rear of your caravan. Payload within the van may have to be moved forward to compensate

Caravan motor movers

The design and fitment of a caravan motor mover shall be in accordance with the NCC Code of Practice 305 and you should ensure you receive a signed installation certificate of compliance from the installer.

Failure to do so may invalidate your warranty

Depending on specification, the wiring in the caravan battery box may feature connections suitable for use with an aftermarket motor mover installation. When fitted, this will feature an isolation switch, fusing, and heavy duty wiring, terminated in two connection points within the caravan battery box.

Thule Bike carrier type	Thule Excellent standard version	Thule Elite G2 standard version	Thule Sport G2 standard version
			
Thule reference	309821	306560	307126
Capacity (# bikes)	2+1+1	2+1+1	2 + 1
Max load to be placed on the rack (kg)	50	50	50
Max individual bike weight (kg)	30	30	19
800mm Fixing rail spacing	Yes	Yes	Yes
850mm Fixing rail spacing	Yes	Yes	Yes

OMNIVENT

Omni-vent (when fitted)

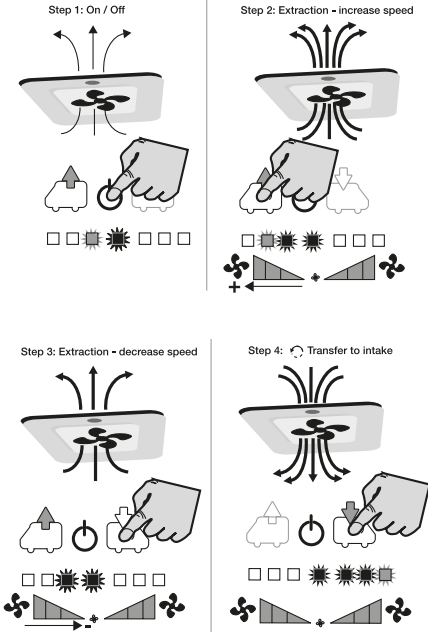

- By pushing on the switch S1 (extract) or S3 (intake), the airflow can be adjusted in 6 steps. See table 19.

PUSH BUTTONS	LIGHTS	SPEED	Ampère	Watt
1x (S1)	■ ■ ■ ■ ■ ■ ■ ■	0	0,2 mA	2,4 mW
1x (S1) + 1x (S2)	■ ■ ■ ■ ■ ■ ■ ■	1Ω	0,17 A	2 W
1x (S1) + 2x (S2)	■ ■ ■ ■ ■ ■ ■ ■	2Ω	0,40 A	5 W
1x (S1) + 3x (S2)	■ ■ ■ ■ ■ ■ ■ ■	3Ω	0,90 A	11 W
1x (S1) + 4x (S2)	■ ■ ■ ■ ■ ■ ■ ■	4Ω	1,55 A	20 W
1x (S1) + 5x (S2)	■ ■ ■ ■ ■ ■ ■ ■	5Ω	3,20 A	40 W
1x (S1) + 5x (S2) + 1x (S3)	■ ■ ■ ■ ■ ■ ■ ■	6Ω	7,20 A	86 W
1x (S1) + 5x (S2) + 2x (S3)	■ ■ ■ ■ ■ ■ ■ ■	4Ω		
*** ** *				
1x (S1)	■ ■ ■ ■ ■ ■ ■ ■	0	0,2 mA	2,4 mW

PUSH BUTTONS	LIGHTS	SPEED	Ampère	Watt
1x (S1)	■ ■ ■ ■ ■ ■ ■ ■	0	0,2 mA	2,4 mW
1x (S1) + 1x (S2)	■ ■ ■ ■ ■ ■ ■ ■	1Ω	0,17 A	2 W
1x (S1) + 2x (S2)	■ ■ ■ ■ ■ ■ ■ ■	0	0,15 mA	0,2 W
1x (S1) + 3x (S2)	■ ■ ■ ■ ■ ■ ■ ■	1Ω	0,17 A	2 W
1x (S1) + 4x (S2)	■ ■ ■ ■ ■ ■ ■ ■	2Ω	0,40 A	5 W
1x (S1) + 5x (S2)	■ ■ ■ ■ ■ ■ ■ ■	3Ω	0,90 A	11 W
*** ** *				

*MIN = 3,7 m³/min (2 W - 0,17 A)

*MAX = 24 m³/min (86 W - 7,20 A)

- In order to save the battery, the speed drops from position 6 to the lowest position after one hour of use.
- It is possible to allow the ventilator to work for 5 minutes on the highest speed (boost). To do this push for 3 seconds on the button S1 (extraction) or S2 (intake). After 5 minutes the ventilator returns to its previous speed setting. See table in fig 20.

Use rooflight

- Close the lid before driving
- To take away the roller blind, unscrew and click the frame off the side of the knob.

Use of the ventilation

- The ventilator is started by the soft switch S2. The middle LED light lights up and the ventilator starts in comfort mode, this is the lowest speed (extract). See fig 18.

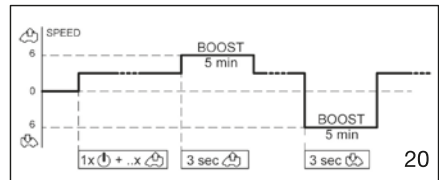
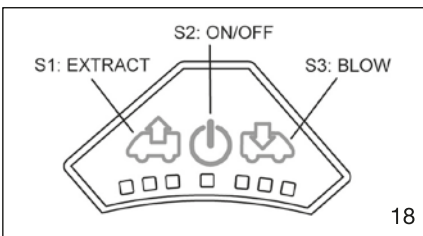

- For reasons of security, the ventilator, the ventilator stops when the tension is too high

FLASHING LED's	PROBLEM
■ ■ ■ ■ ☀ ■ ■ ■ ■	or Tension < 11,1 V or Tension > 19,5V
☀ ■ ■ ■ ■ ■ ■ ■ ■ ☀	Motor blocked
■ ■ ■ ☀ ■ ■ ■ ☀ ■ ■ ■	Motor not connected

Maintenance

The ventilator grid can be removed for cleaning. Also the mosquito screen can be taken out for cleaning.

Remark on the transport of the caravan with Omni-vent

The roof light is only waterproof in the direction of the traffic. When transporting the caravan in the opposite direction, or when the back of the caravan is up, ensure the dome is watertight by using the 'Lock-unlock' (not supplied on a ventilator version) or by using something that ensures that the dome remains closed when being transported.

Digital Reversing Rear View Camera (if fitted)

The rear view camera is a driving aid, it is not a supplement too, nor a replacement for safe driving and good all-round observation. The driver is responsible for the safe manoeuvring and detection of pedestrians, objects and obstacles particularly when reserving. The rear view camera image may be observed at all times when using the camera. When reserving a responsible adult should assist in guiding the driver into confined spaces particularly when obstacles or pedestrians may be present or when visibility or lighting levels are reduced. The mandatory required rear view door mirrors must be maintained and used as the primary rear visibility aid.

The camera image quality can be affected by dirt, road spray, rain droplets, snow, ice and as such the camera lens will require regular inspection and cleaning. Image quality will be reduced at night time or by bright lights shone in low level lighting conditions.

The Caravan Reversing Camera Kit features an LCD monitor for use as a reversing / rear view aid, and also includes satellite navigation software.



- 100% digital car / caravan monitor kit
- Interference-free wireless transmission
- 5" colour LCD screen
- Infra-red night vision

REAR VIEW CAMERA

Cautions: This reversing / rear view camera system is provided as an aid only. It should not be relied upon as the sole indication of your vehicle position or the position of other vehicles or any obstacles. The supplier, manufacturer or supplying dealer accepts no responsibility for damage or injury to property or persons following the use or misuse of this equipment.

System Operation

The monitor and camera system is provided as an aid when reversing your caravan and can also be used to provide an additional view from the rear of the caravan whilst driving.

It should not be relied upon as the sole indication of your vehicle position or the position of other vehicles or any obstacles.

When reversing or manoeuvring please ensure the area around your caravan is clear from obstructions, and do not wholly rely on the camera view, use your mirrors and seek assistance as required.

Caravan Camera

The camera fitted to the rear of the caravan has no serviceable parts, however the following precautions should be observed.

- Check that the camera lens is clean as dirt can obscure the view.
- Never use a power washer or water jet to clean the camera or transmitter.

Connecting the Car

Before you can use the monitor with the camera you need to connect your caravan to the car with the 13 pin towing connector.

When the car engine is started the rear camera will receive power and switch on automatically.

Connecting the Car

Before you can use the monitor with the camera you need to connect your caravan to the car with the 13 pin towing connector.

When the car engine is started the rear camera will receive power and switch on automatically.

Installing the Monitor in the towcar

The monitor has various features you should be familiar with for correct operation.

Firstly attach the mount to the rear of the monitor and connect the car power cable. The monitor mounting plate clips to the rear of the monitor. The windscreen mounting then clips onto the mounting plate. The power cable plugs into the mini-USB socket on the side of the monitor with the other end plugging into the car power socket.

The monitor has an internal rechargeable battery which will last for around 1 hour when used without the power cable. This battery is charged when the power cable is connected. Charging is indicated by a red LED on the side of the monitor.

Now attach the monitor mount to the windscreen using the suction mounting.

- Do not position the monitor in a place that will block the drivers' view of the road.
- Do not block air bags or other dashboard features.
- Safely position the power cable to prevent entanglement or cable damage.
- Ensure the monitor is secure. The suction mount can be moistened to enhance the seal to the windscreen.
- Do not leave the monitor in a visible place when the vehicle is unattended.
- The monitor has no serviceable parts. Do not open the case.
- Use your own depth perception; objects may appear further away than they actually are.

Turning the Monitor power On/Off

To turn the monitor on:

- Press and hold the power key for 3 seconds. The Android operating system will start and present you with a menu.

To turn the monitor off:

- Press and hold the power key for 3 seconds. The power off menu will appear; select the Power off option.

Using the Monitor- Home screen Apps

The monitor uses the Android operating system which is widely used on mobile phones and tablets. Some of the basic Android functions are covered in this manual, but further information can be found in the Android quick start guide available in electronic format from this link:

www.sargentittd.co.uk/AndroidGuide.pdf



Android Settings – use this to setup the initial WiFi connection



Android Music – use this to play any installed music



Android Calculator – select this to use the built in calculator



Reversing Camera – select this to view the reversing camera



Satellite Navigation – select this to access the satellite navigation

Initial WIFI set-up



Note this will usually have been completed by your dealer before delivery. Turn the monitor on and wait for the unit to start up.

- On the menu screen select the Android settings icon .
- Turn the Wi-Fi setting on by sliding the on-screen switch.
- Touch the Wi-Fi setting to show a list of available networks.
- The camera system uses the WIFI_AVIN network, so select this.
- Touch in the password area and enter the password 12345678 to connect.
- Touch done and then connect, WIFI AVIN should then state 'Connected'
- Touch the back button twice to return to the main menu.
- This is a one off operation. The unit will remember the settings for future use.

Note for security reasons the caravan transmitter only connects to one receiver (monitor, phone or tablet) at a time. Please ensure you disconnect one device before trying to connect another.

The Reversing Camera App



Select this to launch the reversing camera App.

- To view the camera select the camera App on the menu screen.
- The software will connect to the transmitter and the camera image will be shown on screen.

The following describes the available buttons / options within the camera App

REAR VIEW CAMERA



Use this button to record the video being displayed (see note)



Not used



Use this button to take a photo of the onscreen image



Signal indicator
white = Signal being received
grey = no signal



Use this button to view a list of recorded video files or photos



Use this button to change the default network name and password (see note)

Note: The unit has a limited storage memory, so try to avoid recording long sections of video otherwise you may fill up the available storage space. The storage space can be expanded by adding a Micro SD card to the unit, inserting it in the slot provided. The unit will work with a card from 4Gb to 32Gb. Please use a good quality card, ideally class 6 or above.

Note: It is possible to change the default network name and password. This should not be necessary and is not recommended, but can be done if you have two systems close together and would like each to be identified differently.

Press the settings button to change the network name and password. When the information is changed the connection to the transmitter will be lost and you will need to reconnect the WiFi using the initial WiFi setup process but this time using your new network name and password.

If something goes wrong with this process the transmitter can be reset back to the factory settings. To do this access the transmitter (located above the number plate under the black panel) and with the transmitter powered up, press the reset button. The network name will be reset to WIFI_AVIN and the password to 12345678.

The Satellite Navigation App



Select this to access the satellite navigation App.

- The first time you start the SatNav App you will have to choose some options and default settings. Please read the guidance on screen.
 - Select language, Done
 - Select Yes/No
 - Next
 - Select voice, we recommend English UK James, next
 - Set or change the Units format (Miles or Metresetc.) next.
 - Set or change route settings, next
 - Finish
 - Speed camera warnings, Leave on, Turn Off
- The full SatNav user manual is available in electronic format from the following link: www.sargentttd.co.uk/IGOGuide.pdf
- The SatNav software is quite straight forward to use, but the following points will help with the initial operation.
- When entering a UK post code please remember to enter the space between the two halves of the code, i.e enter HU17 0TB not HU170TB.
- When entering a destination for the first time you may need to change the onscreen keyboard format. To explain this here is a walkthrough to enter a post code address.

- Select Destination, Find address
- Press on Town, then if the keyboard looks incorrect, press More, select the English keyboard (either ABC, or QWERTY format)
- Enter a test post code (HU17 0TB), pressing the 123 button to switch to number entry and please noting the space (...)
- Select the required address from the list
- If known, enter the house number (39), Done
- Press GO
- An overview of the route is shown for a short while, the unit will start navigating

Switching between Apps



The following Android system buttons (at the bottom of the screen) can be used to switch between App's, close App's or go to the previous screen.

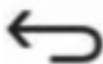

BACK: Opens the previous screen you were working in, even if it was in a different App. Once you back up to the Home screen, you can't go back any further.



HOME: Return to the home screen.



RECENT APPS: Opens the previous screen you were working in, even if it was in a different app. Once you back up to the Home screen, you can't go back any further.

Using the separate App on your Android or Apple iOS phone

If you don't want to use the supplied monitor you can use the separate App on an Android or Apple iOS device.

Head to the appropriate App store (Android or Apple) and search for WIFI_AVIN. Download and install the App.

Initial WiFi setup - The camera system creates its own WiFi Network for the monitor or your own phone or tablet device to connect to, so you need to setup this initial connection.

- On the device menu select the settings option to connect to a new network.
- Turn Wi-Fi on if it is not on already.
- View the list of available networks.
- The camera system uses the **WIFI_AVIN** network, so select this.
- Enter the default password **12345678** to connect.
- Now return to the main menu and start the App.
- If the caravan is connected to the car and the engine is running, the camera image will be shown on the screen.

REAR VIEW CAMERA

Product Specification - Caravan Camera Kit

Transmission Frequency	2400MHz – 2483.5MHz
Unobstructed Effective Range	100m (approx.)
Operating Temperature	0oC – 60oC
Storage Temperature	25oC
Frame Rate	30fps
Video Compression	H.264
Encryption:	WPA2
Operating Humidity:	20% – 80% RH
Monitor Display:	5" TFT LCD
Monitor battery Life:	1 hour (approx.)
Monitor Power Supply:	DC 5V via Car Adaptor

Warranty and Support

For warranty information and technical support, please contact:



Sargent Electrical Services Ltd

If your Caravan Reversing Camera Kit requires service, please discuss this with your dealer or direct with us.

Sargent Electrical Services Ltd
 Unit 39, Tokenspire Business Park
 Beverley
 East Yorkshire
 HU17 0TB

Telephone: 01482 678981
 Fax: 01482 678987

E-Mail: support@sargentltd.co.uk

Seitz Service door operating instructions (when fitted)

To open the door put the key in the lock fig 1.



Turn in an anti-clockwise direction until the locking handle is released fig 2.



Remove the key and turn the handle in a clockwise direction fig 3.



open the door until the sprung stay engages fig 4 (Not fitted to the toilet door).



To close the door push the spring stay in to fold away (when fitted fig 4.) and close the door applying pressure to the hatch until you hear the locks click in to place fig 5.



Insert the key fig 6.



Turn anti-clockwise fig 7.



Then remove the key fig 8 and lock by turning the handle anti-clockwise and pushing back in to place. Note the handle will not push back in to place until all the locks are closed figure 5.



FITTED EQUIPMENT

Vehicle modification and non-standard parts	222
Caravan exterior	222
Condensation	223
Caravan interior	224
Swift Shield fabric	225
HI-MACS® work tops	226
FENIX® work tops.....	227
Care of stainless steel bowl / bathroom / furniture	229
Bulb replacement	230
Winterisation/storage	231
AL-KO chassis	234
AL-KO ATC control system.....	234
Axle types	239
Operating instructions for AKS 3004	244
Overrun device	253
Chassis trouble shooting	256
Chassis accessories	258

MODIFICATIONS

Vehicle modifications & non-standard parts

As the owner of a Swift Group Product, you are able to make any modifications you wish, either by yourself or through a dealer, without affecting the Swift 3/6/10 Year Warranty.

However, please be aware that any issues, resulting directly or indirectly, from a modification or fitment of a non-standard part, will not be covered by The Swift Group Warranty.

WD40 is not recommended for external or internal use

WD40 attacks paintwork and sealants.

If a lubricant is required for Interior hinges, Sliding door tracks, Bottle box hinges, Exterior door hinges, Plastic tracking etc. We recommend "Ambersil 40+" this is readily available from most DIY/ Automotive spare part retailers

Before carrying out any DIY work within the warranty period (3/6/10) years please check with your Swift Group dealer.

IMPORTANT: Replacement parts
The Swift Group recommend that only OEM approved replacement parts are used

Caravan exterior**Plastic Panels (GRP)**

These are used for front and rear panels, side walls and roof.

Cleaning

1. Wash the caravan regularly with mild detergent. Rinse with cold water and leather off.
2. For better protection a similar coloured good quality car wax may be applied.

For sealed areas a mild soap is the best way to clean without affecting the sealant.

Acid or alkaline based cleaners or solvents should not be used.

⚠ WARNING: Under no circumstances use any abrasive cleaning agents or solvents on the exterior panels.

Care should be taken as the silicon in some polishes can attack the rubber used on the exterior for seals and gaskets.

⚠ WARNING: Do not wash your caravan with a high pressure washer as these can permanently damage the seals of your caravan.

Acrylic Windows

Wash windows carefully, as you would with the paintwork of your car, do not scrub windows prior to removing surface dirt and film with a hose pipe - trapped dirt could cause scratching.

Wash with a solution of warm soapy water, windows can then be dried off with a leather.

Small scratches can be removed, consult your dealer.

Catches and stays do not require any special attention or lubrication.

Acrylic (Plastic) Window Condensation

Unlike domestic double glazed windows, your caravan window are not vacuum sealed instead the double panes of acrylic plastic with are fitted with a breathable plug on the inner pane.

It is possible, in weather where extremes in temperatures occur between night and day, that customer will notice condensation between the panes. The same phenomenon may also occur when washing your vehicle on a hot day.

The condensation should clear itself when the ambient conditions return to normal and the air between the panes dries. However, if this is taking a longer time than required, the breathable plug (normally located in the top corner of the window) can be removed, with a pin or sharp object, and replaced when the panes are dry. Care should be taken when doing this.

Acrylic (Plastic) Window Cleaning

The material used to produce most caravan and Motorhome windows is acrylic plastic. While the acrylic used is very durable, it is able to be scratched with relative ease and therefore, care must be taken when cleaning your vehicle with warm soapy water and not to use aggressive cleaning products. Equally, care should be taken when using a drying cloth that it is clean and free from grit.

Condensation

What is condensation

Condensation is the process of change of water from its gaseous form (water vapour) into liquid water when it comes into contact with a surface that is cold. Condensation generally occurs when warm air cools quickly and loses its capacity to hold water vapour, and as a result water vapour condenses to form droplets.

Why condensation occurs

Condensation occurs when warm moist air meets a cold surface. The level of condensation will depend upon humidity levels, how moist the air is and how cold the surfaces are they come into contact with.

If the temperature falls below the dew point temperature, it is quite normal for condensation to occur on any material within the caravan that is cold, for example the external walls, plastic windows etc.

When condensation occurs

Condensation occurs usually in winter months, because ambient temperatures are colder (leading to cold surfaces) and windows and roof vents are opened less so the moist air cannot escape.

Where condensation occurs

Condensation will occur where warm moist air is put into the atmosphere in areas such as in bathrooms (during showering) and in kitchen areas (during cooking).

In the enclosed space of a caravan, the moist air from the kitchen or bathroom areas will inevitably transfer to the rest of the vehicle, which in turn condenses on cold surfaces leading to visible water droplets. This issue is compounded by warm moist air being generated from normal breathing.

Condensation will also form in cold areas where air movement and ventilation is restricted (e.g. cupboards, wardrobes, under beds, etc.)

What is important

It is important to provide ventilation and air flow, so that warm moist air can escape, or be externally cooled, and to use the heating reasonably by not making the caravan too warm such that people perspire, as this will only serve to generate more moist air and therefore more condensation.

However, in particularly cold periods, where the external ambient temperatures are low, condensation may still form on external walls as the insulation levels may well not be thermally able to cope with the difference between the internal and external temperatures.

How can you prevent condensation

Provide ventilation so that moist air can escape.

- a. Good ventilation of the vehicle when cooking or when drying clothes, footwear or pets is essential. Observe when windows begin to show signs of misting and increase ventilation by opening slightly by 1cm or opening a roof vent, as these will help, but keep the habitation door closed as much as possible to retain heat.
- b. If drying damp clothes or towels, open a window to ventilate the area and allow the moist air to escape.

EXTERIOR AND INTERIOR MAINTENANCE

- c. Try to make sure that the caravan is partially heated. It can take a long time for a cold caravan to warm up, so it is better to have a small amount of heat for a long period than a lot of heat for a short time.
- d. After showering, keep the bathroom window or skylights open, and shut the bathroom door long enough to dry off the room.
- e. Fixed ventilation is provided in the vehicle, specifically through the floor, it is important not to block these.
- f. Electrical heating is dryer than gas heating, and introduces less moisture into the atmosphere. Do not use additional portable paraffin or flue-less gas heaters at all.
- g. If left unoccupied and unheated for long periods of time the temperatures can soak down thermally into the entire product and become very cold. Whenever possible, put the heating on at a low level before use by pre heating in cold weather.
- h. Even with reasonable ventilation it is likely if the temperature is less than 5°C and the humidity is high that condensation will occur. Ideally the temperature should be kept about 20°C when occupied.

Mould Growth

Any sign of mould growth is an indication of the presence of moisture and if caused by condensation gives warning that heating or ventilation may require improving.

New vehicles

New products take a long time before they are fully 'dried out' because of the moisture in the natural materials used during manufacture. While this is happening extra heat and ventilation will be required.

Changing Exterior Bulbs

ALWAYS REPLACE LIKE FOR LIKE.

For individual replacement bulb specification, refer to your Service Handbook.

Bulb Replacement and Type

Full details of the bulbs used with your Swift Group product can be found in your Technical Handbook. Details of how to change the various bulbs can be found within our Practical Guides, located on Swift Talk (<http://www.swift-talk.co.uk/forum/topics/swift-group-practical-manuals/>)

Caravan interior

Follow these guidelines to ensure your investment is receiving the very best attention.

Side Walls, Roof Lining

A simple wipe over with a damp cloth and a very mild detergent is all that is needed.

Soft Furnishings

Should be vacuumed occasionally to remove grit and sand and help to keep its smart appearance and ensure long life. The upholstery can be cleaned with a mild, reputable upholstery cleaner. It is recommended that the curtains and pelmets are specialist cleaned only. The foam used in cushions is manufactured to meet fire regulations. It requires time to return to its normal position after prolonged use.

Swift Shield Fabric (Optional)

The Swift Shield fabric fitted to some Swift Group products is a luxury stain resistant durable fabric using Aquaclean® technology. This is a revolutionary fabric treatment that allows you to clean stains using water only. This provides you with simple fabric maintenance in the minimum amount of time.

Cleaning Instructions

Aquaclean® helps to remove the majority of household stains (wine, ink, sauce, fat, mud, chocolate, cream, etc.) in three simple steps:



1. Remove any excess residue on the upholstery



2. Apply water over the stain, either directly or using a damp cloth. Wait a few seconds.

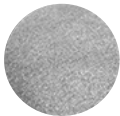

3. Press down over the stain with a damp cloth and rub gently over the fabric in circular movements. If the stain does not come off completely, repeat the process as required.

For further details and stain cleaning demo videos visit the Cleaning Gallery on the Aquaclean® web site: http://www.aquaclean.com/ES_en/home.

Aquaclean fabrics cannot accept any responsibility for misuse of the fabric by allowing bleach or dissolvent substances coming into contact with it.

HI-MACS® WORK SURFACE

HI-MACS® Solid Surface Worktop Maintenance (Elegance/Continental)

Consumer Cleaning, Care & Repair

HI-MACS® solid surfaces are stain resistant, easy to clean and hygienic, ideal for kitchen countertops, vanity tops, and other surfaces subject to the hazards of moisture and heavy wear.

Even the most used areas won't succumb to coffee, ink, or other stains.

No special cleaning products are needed to keep HI-MACS® looking beautiful day in and day out.

While HI-MACS® is extremely tough and durable, like any other fine material it can be damaged if abused or mistreated.

Reviewing this care and cleaning instructions can assist you in understanding how easy it is to care for your new HI-MACS® surface and how you can prevent more severe damage that may require special repairs.

With a little knowledge, you can enjoy the elegance and beauty of HI-MACS® for years to come.

Normal Cleaning

HI-MACS® is non-porous, so it can be wiped clean with a damp cloth or sponge and mild detergents or general purpose cleaners such as Mr. Clean.

If you have a matte finish, abrasive cleaners like Ajax or comet may also be used.

Periodically it may also be helpful to go over the entire surface in a circular motion with an abrasive cleaner or wet Scotch Brite pad to maintain a uniform appearance.

Care

Do not place hot pans directly from the burner or oven on the HI-MACS® surface.

Even though HI-MACS® can withstand sustained temperatures up to 225 °F, prolonged or extreme heat could cause yellowing.

A trivet should always be used under heated appliances, such as crock pots, electric frying pans, etc.

Although minor cuts and scratches in HI-MACS® can be repaired, deep cuts will require the services of professional Strong acids such as those found in drain, toilet bowl, and oven cleaners should be used cautiously around HI-MACS®.

If these items are accidentally spilled, wipe them up at once. Some of these items, when left on the surface, may cause whitening, which can be difficult to remove.

Spills and Stains

While most everyday spills can be removed with the cleaning techniques listed, some troublesome spills and stains such as food dye, tea, and fruit drinks may require more aggressive cleaning. These items can be removed with full strength bleach followed by a general cleanser.

Bleach should only come in contact with the surface for two to five minutes. On a matte finish, if you prefer, you can scrub with an abrasive cleaner. Even nail polish can be removed from HI-MACS® with nail polish remover or an abrasive cleanser.

Cigarettes

While HI-MACS® will not burn, should a lighted cigarette accidentally come in contact with the surface, it could leave a nicotine stain or scorch mark. Either of these can be removed by cleaning with an abrasive cleanser or buffing in a circular motion with a Scotch Brite pad.

Repairing Scratches

For removing superficial scratches, rub in a circular motion with a wet # 7448 Scotch Brite buffing pad until the scratches are removed. Clean thoroughly with soap and water and let dry.

Note: Deep scratches can be removed by carefully sanding lightly with 120 grit sandpaper followed by 220 and 320 grit sandpaper.

Then rub the surface with a wet # 7448 Scotch Brite pad in a circular motion to restore the finish. For added protection, or if any additional luster is desired, after the surface is dry, apply a non-wax polish cleaner or other recommended surface dressing and wipe with a clean, dry cloth. Wipe dry using another cloth.

FENIX Work surfaces (Conqueror/Elite)

Ordinary maintenance

FENIX NTM surface should be cleaned regularly but does not require any special maintenance, just a damp cloth with warm water or mild detergents. Almost all normal household cleaning products or disinfectants are perfectly well tolerated. It is suggested to use a melamine foam sponge - also known as magic sponge - for the normal cleaning and maintenance of the surface.

Extraordinary maintenance

In case of dirt which cannot be cleaned with normal household detergents, due to the irregular topography and closed surface of FENIX NTM, the use of non-aggressive aromatic solvents (acetone) is suggested. In case of micro scratches, please refer to the specific surface thermal healing instructions.

Recommendations for cleaning the surface of FENIX NTM

The table below shows the cleaning products and methods best suited to different types of dirt.

Type of dirt	Recommended cleaning products and method
Syrup, fruit juice, jam, spirits, milk, tea, coffee, wine, soap and ink	Water with a sponge
Animal and vegetable fats, sauces, dry blood, dry wine and spirits, eggs	Cold water with soap or household detergent with a sponge
Smoke, gelatine, vegetable and vinyl based glues, organic waste, gum arabic	Hot water with soap or household detergent with a sponge
Hair spray, vegetable oil, biro and felt tip, pens, wax foundations and greasy make-up, residual solvent marks	MEK, alcohol, acetone with a cotton cloth
Nail polish, spray lacquer, linseed oil	Acetone with a cotton cloth
Synthetic oil paints	Trilene nitre based solvent with a cotton cloth
Neoprene glues	Trichloroethane with a cotton cloth
Traces of silicone	Wooden or plastic scraper, taking care not to scratch the surface
Lime deposits	Detergents containing low percentages of citric or acetic acid (10% max.)

CARE OF SURFACES

General precautions

For best results in cleaning FENIX NTM, it is important to remember certain precautions:

- although very durable, the surface of FENIX NTM must still never be treated with products containing abrasive substances, abrasive sponges or unsuitable products, such as sandpaper or steel wool;
- products with a high acid or very alkaline content should be avoided because they can stain the surface;
- when using solvents, the cloth used must be perfectly clean so as not to leave marks on the FENIX NTM surface. Any streaks can still be removed by rinsing with hot water and drying;
- avoid furniture polishes and wax based cleaners in general, because they tend to form a sticky layer on the dense FENIX NTM surface, to which the dirt adheres.

Maintenance Instructions

Melamine foam Sponge

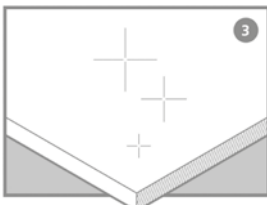
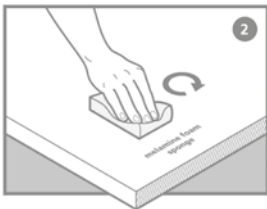
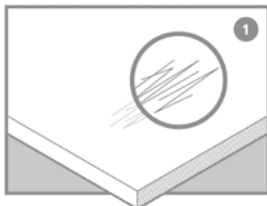

Maintenance Instructions
Iron

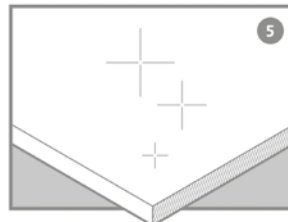
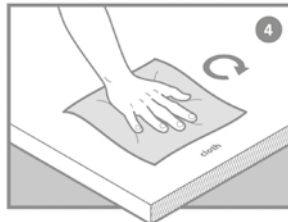
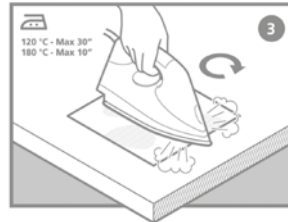
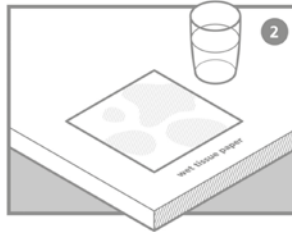
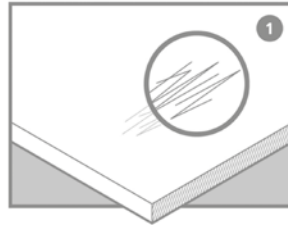

Stainless Steel Bowl Care Instructions

After use always remove any plastic bowl or mat, rinse down the surface and dry with a soft cloth to prevent spotting. For more stubborn dirt or grease a non-abrasive multi-purpose cream cleaner, such as CIF, may be used. To preserve the appearance of your appliance we recommend plastic bowls or mats are not stored in the sink during transit.

The quality of water can affect your bowl's appearance. If the water has high iron content, a brown surface stain can form on the bowl giving the appearance of rust. Additionally, in areas with a high concentration of minerals, or with over-softened water, a white film may develop on the sink. To combat these problems, towel dry the sink after use, and clean at least once every week .

Surface scratching will be most noticeable on highly polished components. These marks are usually only superficial and can be removed with a proprietary stainless steel cleaner/polish. If the surface has a directional polished grain always clean along the grain and **NOT** across. Never use wire wool pads to clean the surface.

Cleaning agents containing bleach should **NOT** be left in contact with stainless steel. This includes many of the new "trigger-dispense" products and some multi surface cream and hand cleaners. Also leaving rubber mats or dishpans in the sink can lead to surface rust or pitting, always remove them after use.

Work Surfaces

You should not stand very hot items on any of the work surfaces. Especially around polycarbonate moulded chopping boards and drainers.

Bathroom/Shower

These products should be cleaned immediately after use. Apply a warm, mild soapy water solution with a soft cloth and rinse with clean water immediately. Abrasive materials must never be used.

Shower Bi-fold Door (When fitted)

The door panels should be cleaned with warm soapy water and a non-abrasive cloth/sponge.

Never use an abrasive or aggressive cleaning agent as these may harm the product and cause premature failure.

Vuplex®, a proprietary plastic cleaner, can also be used. This can be obtained from outlets such as Amazon, ebay etc.

Furniture

A simple wipe over with a damp cloth should be all that is required. Polishing with a proprietary brand of wax polish enhances and maintains furniture in showroom condition.

It must be remembered that because the frames of the doors are made from a natural product, they can be affected by temperature and humidity and may bow under certain conditions. As conditions change they should revert to their original positions.

Kitchen Drainer and Cutting Board

You should not stand hot items on to the removable plastic kitchen drainer. To wash use only warm soapy water, do not use chemicals and bleach.

BULB REPLACEMENT

Bulb Replacement and Type

Full details of the bulbs used with your Swift Group product can be found in your Technical Handbook. Details of how to change the various bulbs can be found within our Practical Guides, located on Swift Talk (<http://www.swift-talk.co.uk/forum/topics/swift-group-practical-manuals/>)

ALWAYS REPLACE LIKE FOR LIKE

Note: LED lights do not contain any serviceable parts and as such the LEDs cannot be replaced alone.

Winterisation

The Swift Group recommends the following winterisation points for customers:

Servicing

Arrange (in advance) the yearly service and habitation check, if the caravan's next service is due while the vehicle is stored.

Electrical

If vehicle is being stored while connected to 230v Mains Hook-up:

- Ensure that the leisure battery is connected and the 20A local fuse(s) is connected.
- The isolator switch on PSU should be in the 'ON' position, however the control panel should be switched 'OFF'.
- If Alde system is installed, there is a frost protection setting, which can be used.
- Vehicles can be left in this condition for extended periods, with the charger operating to maintain the battery. However, periodic maintenance and inspection is recommended, this should include the battery condition.

If vehicle is being stored not connected to 230v Mains Hook-up:

- Connect the caravan to a 230v mains hook up with charger operating for at least 24 hours prior to placing caravan in storage
- Ensure the isolation button on PSU is in the 'OFF' position (button out).
- Ensure leisure battery is connected and 20A local fuse(s) is in place, if an alarm or tracker device is fitted.
- The alarm will eventually drain the leisure battery - we recommend regular (monthly) inspection / re-charging of leisure battery via appropriate means. A solar panel can be used to provide an alternative power source and extend the time between leisure battery requiring a re-charge.
- Remove the leisure battery and store in a dry place, if an alarm or tracker device is not fitted.

- The battery should not be adversely affected by winter temperatures but the level of charge should be maintained to maximise the life span of the battery. This can be achieved using an automotive type battery charger as and when required.

Gas system

- Ensure the gas supply is isolated at the gas bottle, and ensure that the gas manifold taps are off.
- Check the age and condition of the high pressure gas hose and regulator, and replace if required.

Appliances

- Check the battery expiry date on the smoke alarm and replace or remove as required.
- Ensure the fridge is turned off.
- Clean the inside of the fridge.
- Prop the fridge door open, and if possible, the internal freezer compartment door for ventilation.
- Fit fridge vent winter covers (if available).
- Ensure all hob / oven / microwave surfaces are clean.
- If the caravan is going to be left connected to 230v supply while not in use, ensure the microwave is unplugged.
- Drain the toilet reservoir.
- Empty the toilet cassette.
- Drain the toilet reservoir.
- Empty the toilet cassette - The Thetford Cassette porta potti is easily winterised for storage.

Empty the fresh water tank using the drain tube / fresh water tank level indicator (level indicator on electronic models only).

Pull the lever indicator / drain tube down from top plug position and outward through door opening to drain water from the tank.

Empty the water fill funnel by pulling the bottle away from tank.

Remove the small water cap on the filler bottom, allowing water to drain from the water funnel. (Not C-200 toilet).

WINTERISATION

Do not tighten caps, this helps in keeping unit dry. The pour out spout and vent plug can be removed. Seals should be greased if necessary with acid-free Vaseline.

Exterior (Body / Chassis)

- Ensure that all windows, skylights and access doors are closed and secured.
- Ensure all fixed ventilation points (high and low) are clear from debris and obstructions.
- Ensure the vehicle is not parked where falling debris (i.e. leaves, tree sap) could cause damage.
- Avoid leaving the vehicle parked in soft ground, long grass or a potential area where standing water may form.
- Lubricate relevant points on the chassis.
- Remove road wheels, using the correct jacking points and suitable axle stands, or if being left on road wheels rotate wheels (every two weeks) and ensure the correct tyre pressures are maintained.
- A purpose made cover maybe used, but please ensure the cover is a good fit, breathable and securely fitted.
Note: A poorly fitted cover can rub and damage the bodywork. Non-breathable covers will encourage mould to grow and if fitted prevent the operation of a roof mounted solar panel (model specific)

Interior (Furniture / furnishings)

- Open all lockers and internal doors, to ensure good circulation.
- Remove cushions and store them in a dry location or ensure all cushions are placed in a well ventilated area.
- Close all blinds and curtains. Customers are reminded to check the tension on blinds after storage if left closed for long periods.
- Thoroughly ventilate the caravan by opening doors or windows periodically.

- Placing water absorbent crystals in the van during the winter months, will help reduce moisture levels and mould growth.
- We do not recommend leaving portable heaters in the van unattended.

Water system

Water expands as it is frozen, and so trapped water, when it expands, can damage the tap / valve / pump or pipe it is trapped within. For this reason, (in addition to reasons of hygiene), the water system should be fully drained when not in use, particularly in colder weather.

Follow the basic steps outlined below to remove water from the system (current caravans):

- Disconnect any external water source, external submersible hose or pump.
- Locate the 'Yellow' drain valve, which is floor mounted and will be next to the water heater. Move the lever on this valve to the vertical.
- If a water tank is fitted, open the tank drain valve located on the floor, next to the heater drain valve as above.
- Open one of the taps (the kitchen tap is the most convenient) to the middle (hot and cold mix) position.
- Turn on the pump using the button on the control panel, and leave the pump running until water no longer flows from the tap.
- Open the vanity tap and shower tap mixer, again to the centre hot and cold position and leave them open whilst the caravan is out of use.
- Also remove the shower head, and leave the head in an upright position.
- If present connect the external shower handset and fully open to drain, disconnect and store.

After a short while the majority of water will have left the plumbing system. At this point however it is still important to ensure that the pump itself is 'dry'. During this part of the winterisation, a suitable absorbent cloth or container should be used to catch a small amount of spilled water that will result.

The pump should be disconnected on the output side of the pump, and run for a short while to expel any water contained within the pump body and filter. This is also a good time to disassemble and clean (if necessary) the filter fitted on the input side of the pump.

The easiest method of disconnecting the pump is to remove the quick-release tabs from the Posi-flo type pump (details of releasing push fit plumbing connections can be found in this handbook).

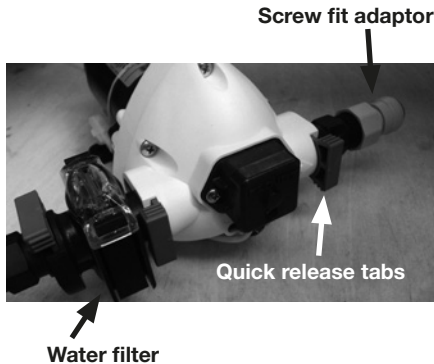

During this time, if galvanised items are stored in damp or wet conditions, where there is little or no air movement then the zinc will continue to react with the moisture that is present. In so doing the zinc will produce excessive amounts of zinc hydroxide. This is seen as a bulky white deposit on the surface of the galvanising and is often referred to as wet storage stain (white rust).

You can help to prevent wet storage stain (white rust) occurring. You can do this by washing the chassis with clean water. You must then allow an adequate flow of dry air to ensure that they dry off completely.

The caravan should not be parked on long grass where the air flow around the chassis is hindered and the dampness retained. It is most likely that the chassis will rapidly show signs of wet storage stain under these conditions.

It is also very important to do this during the winter months to ensure all salt deposits from road spray are completely rinsed off.

Galvanised Parts

Wet storage stain (white rust)

Hot dip galvanising has been used for many years throughout the automotive industry and is widely regarded as one of the best forms of corrosion protection.

When the steel is withdrawn from the galvanising bath it has a clean, bright surface. Over a period of time this changes to a dull grey colour as the surface zinc reacts with oxygen, water and carbon dioxide in the atmosphere to form a tough, stable, protective layer.

AL-KO CHASSIS/ATC CONTROL SYSTEM

AL-KO chassis

Manufactured from high quality steel, the chassis has extra deep sections to provide strength at points of maximum stress.

Large elongated holes are punched in the longitudinal chassis members, to reduce weight to a minimum. Each hole incorporates a return flange to maintain the required strength and provide rigidity in the extra deep sections.

The chassis frame is of a bolted construction which allows replacement of individual parts should the need arise.

The chassis is Hot Dipped Galvanised. This is regarded as one of the best forms of corrosion protection. It does however require minimal maintenance in certain circumstances and should, if properly maintained, last the lifetime of the vehicle.

When new, the chassis is of a bright and shiny appearance. As the galvanising cures during the initial 2/3 month period, this will gradually change to a medium/dark grey colour. This grey finish is the ideal, giving the correct protective coating. During this curing period the surface should be protected to avoid possible wet storage stain, in the form of a soft, light coloured, porous, oxidation layer. If the chassis members are in contact with any salt deposits from roads this should immediately be washed off with a high pressure washer. Salt attracts moisture allowing the surfaces to remain wet, this prevents curing and also allows formation of wet storage stain.

It is recommended that the chassis/ components are washed off, using a pressure washer on an annual basis (especially after winter usage), to avoid undesirable build up of salt and dirt deposits.

The galvanised chassis should not be painted or subjected to any other protective treatment.

Should the galvanising become superficially damaged exposing the steel core, this should be cleaned and treated with a Cold Galvanising Spray obtainable from vehicle accessory outlets.

Damage to chassis members through impact etc, MUST NOT be straightened or welded. Damaged chassis members MUST be replaced.

Drilling or Welding of Parts or Accessories

The chassis is designed and built to precise tolerances and must not be drilled or welded (except in accordance with certain AL-KO Accessory Operating Instructions). Failure to comply will invalidate all warranties.

AL-KO ATC trailer control system (where fitted)

AL-KO ATC is an electronic, emergency Control system for caravans and trailers. It automatically recognises critical swinging motions and applies the caravan brakes accordingly to regain control of the caravan and car.

General notices

Read and act in accordance with the following operating instructions before attempting to use AL-KO ATC. AL-KO ATC is a safety related product and, therefore, should only be fitted by an authorised AL-KO trained technician with experience of working with electrical installations. Any evidence of removal or disassembly, other than by trained technicians, will immediately invalidate the product warranty.

Safety Information

AL-KO ATC is a passive safety product that activates the braking system on the caravan in unsafe driving conditions. The driver has a responsibility under law to ensure that the elements of towing safety are met, including driving within the legal speed limit, consideration of road, weather and other traffic conditions, correct loading and coupling of the caravan.

AL-KO ATC is designed to fit only on AL-KO Chassis and is not suitable for non AL-KO Chassis. AL-KO ATC only functions on caravans with a rigid towbar. The electrical connection between the towing vehicle and caravan must be in good working order.

AL-KO ATC CONTROL SYSTEM

Display Colour	ATC Condition	Diagnosis	What to do	Outcome	Status
Green	ATC Active	Everything Ok			
Green Flashing	ATC Active	Self test incomplete	Drive forward to detect movement to complete self test and recheck LED.	Green (Constant)	Ready for journey
Red	ATC Inactive	Possible to continue journey	Remove 13 Pin plug and wait 5 seconds. Reconnect plug.	Green Red	Ready for journey ATC Error logfile memory exceeded. Caravan can be towed, but ATC will not apply caravan brakes in the event of instability. See below *
Red flashing	ATC has detected a fault.	Do not continue a fault with ATC connected	Remove 13 Pin plug and wait 5 seconds. Reconnect the plug	Green Red (flashing)	Ready for journey ATC faulty, and cannot be driven. Remove push-rod as shown on page 236. Consult AL-KO, see back page for details.
LED not working	ATC has no power	Check push rod position as shown on page 5 of the ALKO ATC manual before continuing journey.	Remove 13 Pin plug and wait 5 seconds. Reconnect the plug. Check for constant live - refer to system requirements.	Green LED not working	Ready for journey If power ok, check push rod position: Red line visible - do not drive vehicle. Red line not visible - possible to continue journey but consult AL-KO see back page for details.

AL-KO ATC CONTROL SYSTEM

System requirements

ATC draws power from the towing vehicle towbar and requires connection to either: Twin * ATC stores operating errors in a logfile which over time will become full and will result in the solid red light appearing. This needs to be erased and can be done easily by connecting the caravan to a 12 volt supply for a period of 12 hours. The power required to carry out this function is minimal. Most occurrences of these errors are due to power supply problems to ATC which could be due to low voltage, or an intermittent power supply from the towbar.

Maintenance and Warranty

ATC is maintenance free and requires no servicing. In case of any damage to ATC, please contact AL-KO. ATC is a sealed unit and any evidence of removal of ATC or the component parts including outer casing and fixings will immediately invalidate any product warranty.

If ATC is fitted as standard by the vehicle manufacturer then ATC is covered for the same duration of the vehicle warranty or whichever is longer.

If ATC is subject to a call out under warranty and found to comply with the relevant specification or standard, then the cost of any testing or callout charges will be borne by the customer. We reserve the right to request credit card details to cover payment in advance.

Removal of a push rod



Using a 17mm spanner, slacken locking nut on push rod away from Bowden cable abutment as directed above.



Unscrew push rod from brake rod and slide it from the guide tube. Remove the locking nut from push rod using two 17mm spanners.



Re-apply the removed locking nut onto brake rod thread to secure ball nut as shown above. ATC is now deactivated.

The AL-KO formula optimum safety

The AL-KO formula for optimum safety is a combination of industry leading technology that ensures the safest possible driving conditions for caravan owners. The formula provides total confidence and control when towing a caravan.



As an emergency system, AL-KO ATC automatically safeguards against a number of critical driving conditions. When used in conjunction with AL-KO AKS, there is no safer package for towing a caravan.

+



The AL-KO AKS Stabiliser device permanently suppresses small swinging and pitching movements in the trailer and increases the critical driving speed by approx 20%.

+



A safe driving style and correct loading combine with AL-KO technology to ensure optimum safety and unparalleled towing stability.

7-Pin Connection

ATC can be connected via the auxiliary 12S (white/grey) plug and requires power on Pins 4 (permanent supply) and 3 (earth). Please ensure that your vehicle towbar is correctly connected to ensure correct ATC operation. This can be checked with the use of a multimeter. Important - A 20 amp fuse is required for the constant 12V supply to Pin 4 on the 12S socket. If only a single fuse is fitted to supply both Pins 4 and Pin 6, the power supply capability of the installation must be checked and a minimum fuse rating of 25 Amps must be used.

13 Pin Connection

ATC can be connected via the 13-Pin plug and requires power on Pins 9 (permanent supply) and 13 (earth). Please ensure that your vehicle towbar is correctly connected to ensure correct ATC operation. This can be checked with the use of a multimeter.

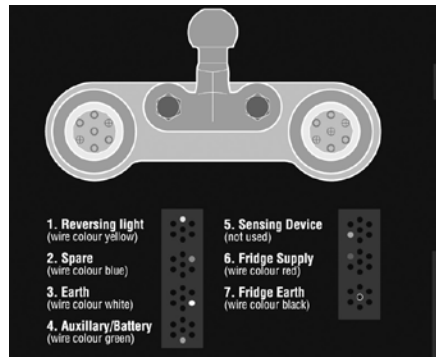

Operating instructions

After coupling the caravan correctly to the towing vehicle, connect the 12N & 12S plugs or the 13 Pin plug to the towbar.

Upon connection, ATC will carry out an initial self test and the LED light on the front fairing will light up RED. During the self test, the sound of the push rod moving inside ATC can be heard. When the self test is complete, the LED will turn GREEN or flashing GREEN to signal that ATC is active. If the LED does not change to green, then ATC is not functioning correctly. The table provided on page 235 details what to do in this case. Prior to commencing any journey, ensure that the caravan lighting is fully operational and check

AL-KO ATC CONTROL SYSTEM

the vehicle is loaded appropriately, the nose weight and tyre pressures are correct, and confirm that the caravan is coupled to the vehicle with the breakaway cable correctly applied. Always re-check the ATC LED is green after any interval during a journey, such as a service station break.



Troubleshooting

Should you experience a fault with ATC, the LED light on the fairing will change colour. Therefore, refer to the table on page 235 and follow the instructions. If no illumination of the LED is evident, refer to system requirements on page 236 and check towbar wiring for permanent supply.

In the unlikely event that you receive a red flashing LED light and disconnecting and re-connecting the power does not alleviate the problem, check the push rod position as detailed below. Locate ATC on the axle and check the position of the push rod. If no red line is visible, ATC is not active, and can be driven. However, we recommend that you contact AL-KO at the earliest convenience.

If the red line is visible on the push rod, as shown on the left, the caravan should not be moved. The push rod needs to be removed to deactivate ATC. Using two 17mm spanners, the removal process is as shown on page 236.

Loadings on Coupling Heads, Overrun Assemblies and Axles

The permitted 'nose' weights of the coupling head/stabiliser, overrun assembly and drawbars, must never exceed the lowest value stamped on the assemblies.



Fig. 1

The maximum axle loading is that stamped on the plate (Fig. 1 example axle plate) located in the centre of the axle, facing rearwards.

Note: Do not attempt to remove as this will void the plate.

The third line down marked "Capacity" is the maximum permitted axle loading and must not be exceeded.

The caravan manufacturer may have stated a lower maximum loading weight on the plate fitted adjacent to the entrance door, this then becomes the maximum permitted load and must not be exceeded. We recommend you record the Axle details for future reference.

It may be possible if required for the caravans MTPLM to be upgraded.

Your caravan dealer will require the following details from the axle plate.

(Example of information ref Fig 1)

- Order - CHA402248
- Qty - 1 of 2
- Date - 3 May 05
- Type - B850-10
- Capacity - 1000E

Please consult your Swift Group Dealer to confirm if this is possible.

Loading

Loads to be carried in the caravan should be placed directly over, or as close as possible to the axles, otherwise the handling will be impaired. Maximum gross weight, as advised by the caravan manufacturer, must not be exceeded without approval from AL-KO.

Maximum loading is defined as the difference between ex-works weight and the permitted total weight.

Load Too Far Forward (Fig 2)

Steering and braking ability reduced. Increased loading on the rear axle and chassis of the tow vehicle.



Fig. 2

Load Too Far Back (Fig. 3)

High skid risk together with poor braking effect.

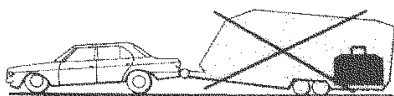

Fig. 3

Load Over Axle (Fig 4)

Optimum road holding together with maximum braking effect. Exceptionally heavy loads should be placed directly over the axle.

Attention should be paid to the legal regulations regarding the permitted pressure exerted by the towbar on the towed unit.

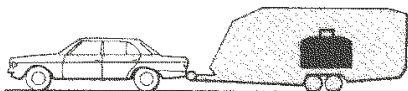

Fig. 4

Axle types

Safety Precautions

No welding is permitted on AL-KO Axles

It is important that the wheel and hub / brake drum are compatible. This means that the PCD, wheelbolts and inset must all be compatible with both the hub/brake drum and the wheel rim.

Particular attention must be paid to the recommended torque figures for the wheelbolts (see pg 32).

The axle type details shown on axle type plates must not be obscured or made illegible by application of any additional surface finish.

Operating Instructions

Service Brake

When the towing vehicle is braking or travelling down hill, the overrun device shaft is pushed in (dependent on the magnitude of the thrust on the shaft) and presses on the overrun lever. This acts on the bowden cables and expander mechanism, which in turn expands the brake shoes applying the wheel brakes.

Hand brake

With the gas strut version, pull the handbrake lever until upright. With the spring cylinder version, pull the handbrake lever right up to the last tooth. The caravan is then braked.

⚠ WARNING: Please note that with the handbrake fully applied, the caravan/trailer is able to move backwards by 25 cms until the spring cylinder/gas spring takes effect.

Maintenance and Cleaning

Maintenance of Euro-Plus/Euro-Compact and Euro-Delta.

The above semi-trailing axles come fitted with maintenance free wheel bearings (greased and sealed for life) and no adjustment is necessary.

AL-KO SPARE PARTS

Note: The hub bearing is not protected against water ingress. Check wheel brake linings for wear every 10,000 kilometers (6200 miles) or every 12 months via the inspection hole

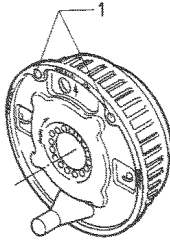

Fig. 5

(Fig. 5/Item 1). Adjust if necessary. Where continuous travel in hilly regions or high mileage is experienced, earlier inspection and adjustment may be necessary.

Note: The flanged hub-nut, located under the dust cap, used to keep the brake drum in situ, is a ONE-SHOT NUT (ie. must only be used once). If removed it must be replaced with a NEW flanged nut - torqued to $290 \pm 10 \text{ Nm}$ ($214 \text{ +/- } 1 \text{ 7.5 lbs/ft}$). A small amount of special mineral grease, available from AL-KO must be applied to stub axle thread prior to fitting the new flanged nut. After fitting excess grease must be removed with white spirit.

The rear hexagon cap head bolt located under the black plastic cap **MUST NOT BE DISTURBED** under any circumstance. Interference with this nut will result in immediate tyre wear and damage to the braking system and **WILL INVALIDATE ALL WARRANTIES**. Should the rear nut accidentally be disturbed then the complete axle must be returned to AL-KO for resetting of the toe-in and camber.

No attempt should be made to remove the bearing. In the event of damage to the bearing or drum, only the drum complete with bearing and circlip will be available as a spare. No grease is used in the hub other than the mineral grease on the stub axle. No grease should be placed in the DUST cap. This is not a grease cap as used in all previous hubs

Spare parts

Spare parts are safety critical parts! For this reason when fitting spare parts we recommend the use of original AL-KO parts or those parts that they have explicitly approved. The reliability, safety and suitability of parts designed especially for their products, has been determined using a special test procedure. In spite of constantly monitoring the market they are unable to assess or vouch for other products.

If repair work or servicing is required, AL-KO have a large network of AL-KO service stations throughout Europe.

To establish the correct spare parts required for your axle you should always quote the axle type (axle identification plate Fig. 1, page 238) and Spare Part Identification no. (ETI No.), which will be stamped onto the wheel brake or on the identification plate (Fig. 6). Please establish these numbers before contacting AL-KO or a Service Agent.

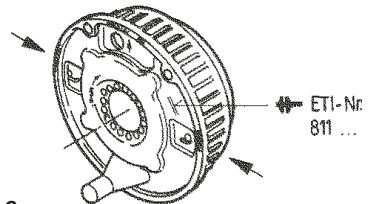

Fig. 6

The AL-KO rubber suspension axle has been designed and developed to suit all types of road conditions and is maintenance free.

Three rubber elements are contained within an hexagonal axle tube. These provide suspension and have inherent damping characteristics.

Figs. 7, 8 & 9 show the deformation of the rubber elements at the extremes of suspension movement.

The axle is designed to ride with the suspension drop arm at, or slightly below, the horizontal position.

For Trouble Shooting & Fault Finding please see Table 1 on page 256.

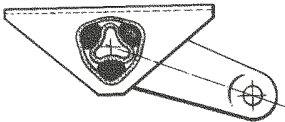

Fig. 7

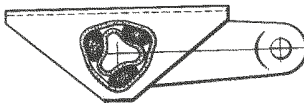

Fig. 8

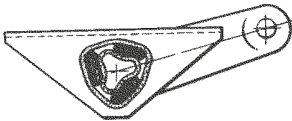

Fig. 9

AL-KO braking system adjustment

1. Ensure the towing shaft with coupling head is pulled **FULLY FORWARD**. (Fig. 10).
2. Release the handbrake to the **FULLY OFF** position. If the handbrake will not go down the whole way because of the fairing or any other obstruction; then the fairing must be cut away and/or the obstruction removed to achieve this desired position. It will not be possible to set up the braking system properly when the handbrake is not in the **FULLY OFF** position. (Fig. 10).
3. Jack up one side of the caravan, using the AL-KO Side Lift Jack System. (see Jack Operating Instructions).
4. Remove the inner plastic bung from the backplate to expose the "starwheel" adjuster access. (Figs. 10 & 11).
5. **ALWAYS** rotating the road wheel in the forward direction - **NEVER** backwards; adjust the starwheel with a suitable screwdriver, in the direction of the arrow embossed on the backplate until there is resistance in the wheel rotation. (Fig. 11).
6. Slacken off the starwheel adjuster until the road wheel turns freely in the **FORWARD** direction. (Fig. 11).
7. Check the adjustment at the end of the brake cable where it is secured to the abutment (bracket), welded to the centre of the axle.

When the inner cable is pulled out it should extend between 5 and 8 mm. (Fig.12). (On tandem axles a double abutment (bracket) is fitted to the front axle **ONLY**).

8. Repeat for other wheel or wheels.
9. On tandem axles the brake cables from the rear axle should pass over this axle and cross over each other, before being connected to the abutment (bracket) on the front axle. Where ATC is fitted to a tandem axle caravan the brake cables **should not** be crossed over.

AL-KO BREAKING SYSTEM ADJUSTMENTS

10. Ensure the balance bar (compensator) is being pulled evenly (Figs.10 & 12). Excessive movement to this bar (double on tandem axles) would indicate possible incorrect adjustment (if appropriate, repeat step No. 7 - Fig. 12).
11. Check the brake rod support bracket, (fixed to the floor) IS supporting the brake rod evenly. The brake rod **MUST ALWAYS** run straight, **NEVER** bent or curved under any fittings. On tandem axles, using the double balance bar, a brake rod support tube (ALKO Part No. 228827) **MUST ALWAYS** be fitted on the end of the brake rod, passing through the centre aperture on the abutment.
12. Remove the slack in the brake rod by adjusting the long ball nut, rear of the balance bar, ensuring the overrun lever makes contact with the end of the towing shaft. Note! Over adjustment to the long ball nut (Fig. 12/Item 2) could induce movement of the inner brake cable, reducing the effective clearance of the brake shoes. If the overrun lever will not make contact, it is possible the two lock nuts, forward of the spring cylinder, are incorrectly adjusted. Loosen the nuts and adjust brake rod as above (Figs. 10 & 12).
13. **OVER ADJUSTMENT** of either the wheel brakes or linkages, will result in difficult reversing causing the wheels to "lock-up".
14. When parking, the handbrake lever **MUST ALWAYS** be engaged into the fully upright position (90°). This is to compress the spring within the spring cylinder and thereby create an energy store which will automatically engage the brakes further should the caravan move. If difficulty is experienced in this operation, try easing the caravan backwards with one hand while engaging the handbrake fully with the other. This manoeuvre should not be attempted on a rearwards facing slope. In this case wheel chocks should be used combined with the handbrake. See page 254 for all handbrake operations.
15. Finally, if the road wheels have been removed, re-tighten using a calibrated Torque Wrench (see Changing a wheel). Remember to over-tighten is just as dangerous as to under-tighten, as this can distort the wheel rims. Avoid the use of power wrenches.

 **WARNING:** The torque settings should be rechecked regularly. Wheel bolts should **NEVER** be lubricated.

AL-KO Breaking System Adjustments

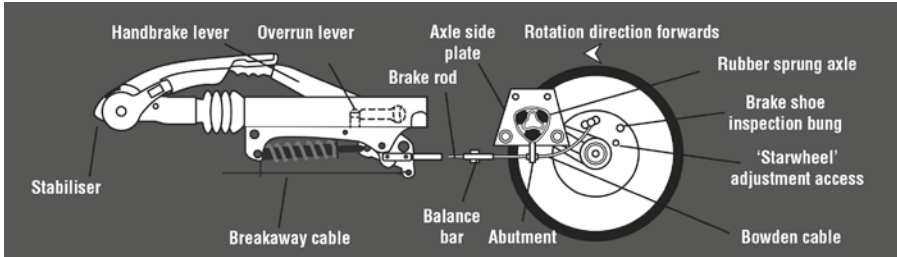

Figure 10

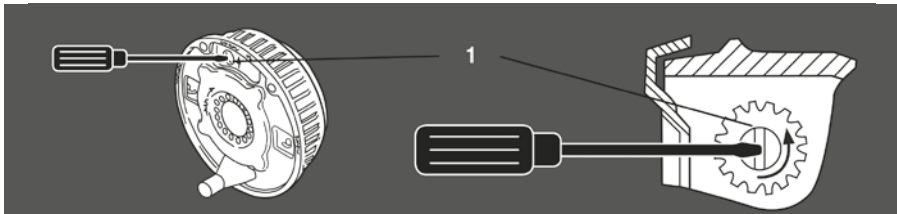

Figure 11

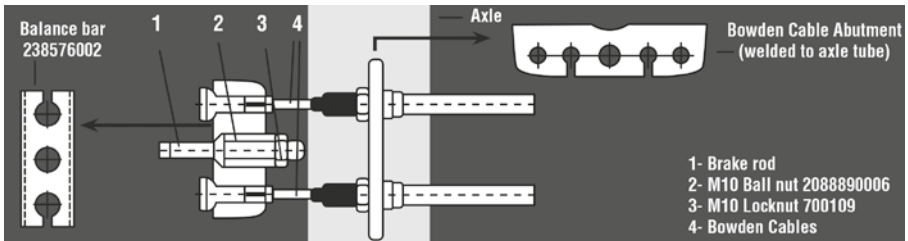

Figure 12A

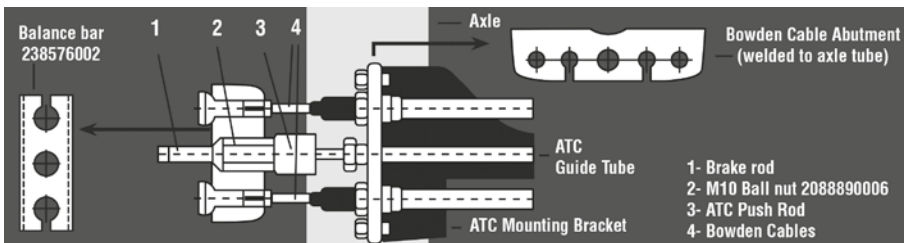

Figure 12B

AL-KO 3004 STABILISER

AL-KO AKS 3004 stabiliser

Regulations

1. The AKS 3004 stabiliser must be used in conjunction with 50mm dia. towballs which conform to EC Directive 94/20 (DIN 74058 or local equivalent).
2. Suitable for attachment to drawbars or approved overrun braking equipment for single (and tandem axle) caravan/trailers, with a minimum weight of 200kg and a maximum permissible weight of 3000kg.
3. EC design approval has been given to the AL-KO AKS 3004 coupling under permit No. e1*94/20*0930*00.

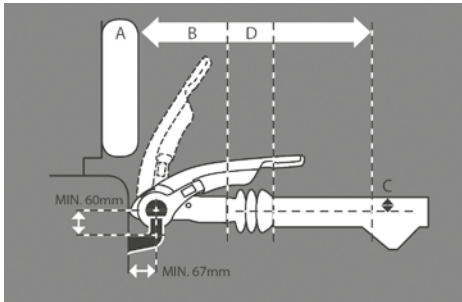

Figure 1 - Necessary clearances

Restrictions of use

1. The trailer coupling may only be connected to towing vehicles where the clearances for the stabiliser can be observed, in accordance with EC Directive 94/20 or UNECE R55 (DIN74058). If these clearances are infringed by special attachments, then the use must be checked separately.

The area above the towball of the vehicle must be free from vehicle components or attachments (A) (e.g. spare wheels, platforms etc.)

The clearance for the stabiliser lever must be at least 330mm (B) + the stroke movement (D) (85mm-100mm), which equates to 440mm when used in conjunction with an AL-KO overrun.

2. Swan Neck towbars (fixed or detachable) are suitable for use with the AKS 3004 providing they comply to EC Directive 94/20 or UNECE R55 and have the required minimum 60mm clearance, measured from the centre of the towball (Fig 2).

Safety warnings

1. In accordance with EC Directive 94/20, couplings of type A 50-1 cannot be used (see Fig 3), your warranty will be invalid if this type of towball is used.
2. For UK use, use the extended neck towball (type A50-X).
3. A bolted-in type ball coupling (Fig 4) is only permissible if the thread is locked or welded.
4. The AKS 3004 cannot be used with a laterally attached reversing lever, on the left side, when facing the direction of traffic.
5. The towball must be free from grease, paint and other residue, otherwise the stabilising effect is greatly reduced. Coated towballs must have the coating completely removed (use 100 or 120 grain emery paper). If this is not done increased towball wear will occur and may cause damage, or reduce the efficiency of the stabiliser.
6. If friction pads become contaminated with grease, they should be replaced.
7. The AKS 3004 should only be operated by one person, when opening or closing the handle, to reduce injury risks.

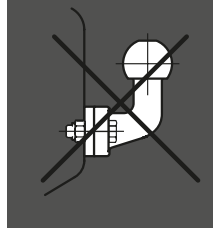

Figure 3 - A 50-1 coupling

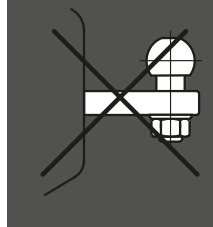

Figure 4 - Bolted in coupling

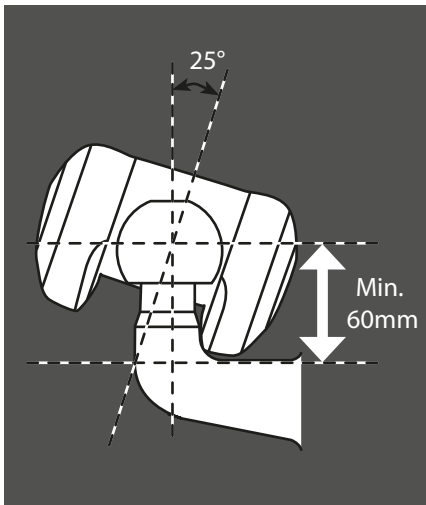

Figure 2 - Max suitable rotation of overrun device is 25°.

AL-KO 3004 STABILISER

AKS 3004 operating instructions**AKS 3004 specifications**

Coupling Handle (Fig 7/Item 1)

Stabiliser Lever (Fig 7/Item 2)

Preparation for coupling/uncoupling

The Stabiliser lever (Fig 7/Item 2) must be in the uppermost position (open).

Coupling up

Pull the coupling handle (Fig 8/Item 1) up in the direction of arrow. The coupling mechanism has an open position, as long as the AKS 3004 is not placed on the ball, the handle will remain open. Put the opened coupling onto the clean towball. The handle must now make an audible click and return to the flat position.

⚠ WARNING: The coupling is correctly engaged when the green edge of the safety indicator button is visible (Fig 9/Item 2).

Secure Jockey Wheel for transit:

After coupling fully retract the jockey wheel inner tube so that it locks against the jockey wheel outer tube.

Slacken the jockey wheel clamp handle and raise the complete assembly to its highest position with the wheel facing backwards within the hitch cover ensuring that it doesn't come into contact with the brake rod assembly. Fully tighten the jockey wheel clamp handle to ensure the jockey wheel is firmly held in position.

Stabiliser unit

To operate the stabiliser (once coupled to the towball), simply press the stabiliser lever down as far as it will go (Fig 9/Item 3).

To ensure the stabiliser is correctly coupled, check the arrowhead lines up with the black line marked 2 (Fig 9 /Item 4 and Fig 13/C).

Uncoupling

Pull the stabiliser lever up as far as it will go, open the coupling handle and lift the AKS 3004 from the towball by using the jockey wheel winding handle.

Note: The friction pads (Fig 10/Items 1, 2 & 3) are pressed against the towball and hence generate a stabilising/damping force. These pads are therefore subject to wear over time, however they will have a long service life (circa.30,000 miles), provided they are well maintained and kept free of grease/dirt.

Operating instructions

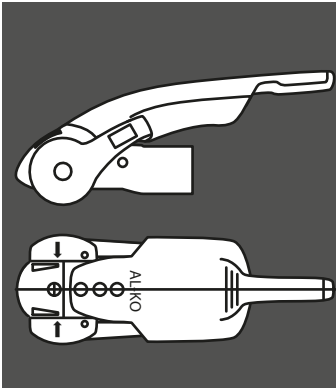

Figure 6 - AKS 3004 stabiliser

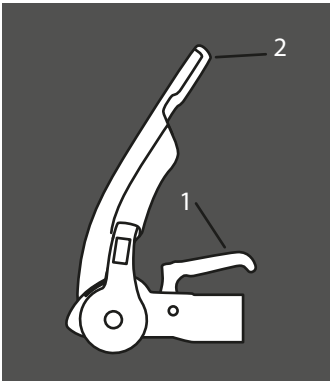

Figure 7 - Raise stabiliser lever

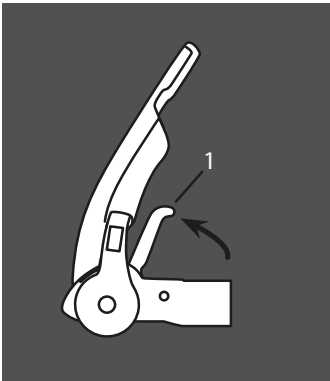

Figure 8 - Pull coupling handle up

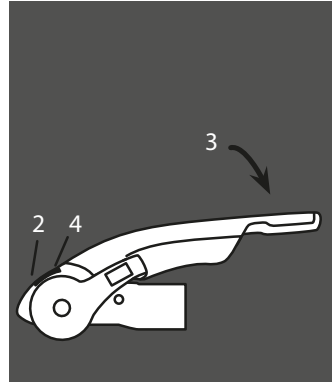

Figure 9 - Correct engagement with towball

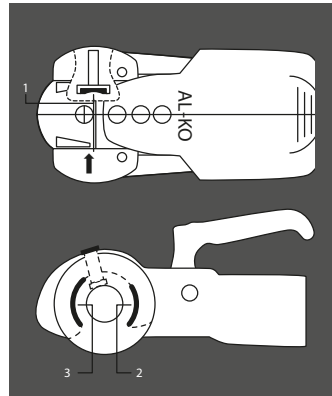

Figure 10 - AKS 3004 friction pads

Manoeuvring

For easier manoeuvring (on campsites etc), pull the stabiliser lever to the 'up' position.

Please do not use the stabiliser lever as a manoeuvring handle. Please use the handles on the caravan or fit the AL-KO manoeuvring handle to your jockey wheel (available separately).

1. During opening or closing, the AKS must only be operated by one person.
2. Press stabiliser lever down by hand force only. DO NOT use your foot or an extension bar, this will damage the components (below).

AL-KO 3004 STABILISER

3. When opening or closing the stabiliser lever, please ensure your hand does not touch the coupling handle - you may accidentally trap your fingers (below).

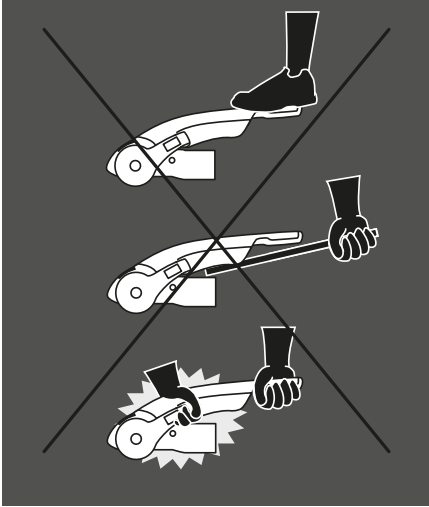

Figure 11 - How not to operate the stabiliser handle

Noises whilst driving

As a rule, the friction pads of the AKS 3004 do not make a noise during driving. Any clicking, creaking or squeaking noises that do arise may be due to the following:

- a. Foreign bodies, dirt or exhaust particle build up between the friction pad and towball.
- b. Dry operation of the drawshaft inside the overrun device.
- c. A detachable towball which has too much play in the locking mechanism.

Remedial action

- a. Clean the towball and friction pads before each journey by lightly rubbing the surfaces with a light emery paper (100-120 grit) or use brake cleaning fluid to remove the build up.
- b. Lubricate the drawshaft sleeve via the grease nipples. In addition, push the gaiter forward and grease (DIN 51 825 KTA 3K) the exposed part of the shaft (Fig 12).
- c. Visit a specialist workshop to have the ball holding area checked for damage and the locking mechanism for function. If necessary, change the towball.

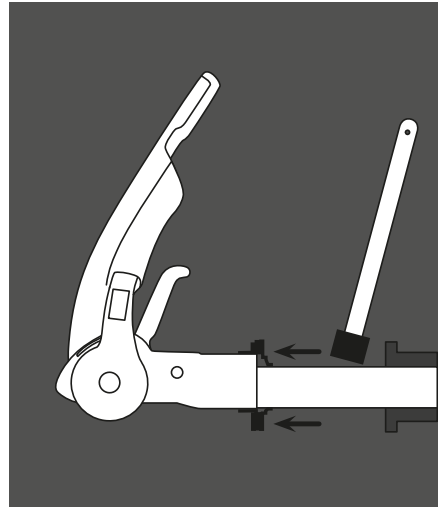

Figure 12 - Remedial action

Checking the efficiency of the side friction pads

1. Check that the stabiliser is correctly coupled by ensuring the coupling handle is fully down and the red indicator button is in the raised position.
2. Push the stabiliser lever (Fig 13 - Item 1) down until resistance is felt (i.e. The friction pads are in contact with the ball but not yet under pressure).
3. Check the position of the arrowhead on the arm of the stabiliser. If it lines up with the two green lines then the friction pads are still as new (Fig 13 - A).
4. If the arrowhead lines up with the two red lines then the friction pads are worn and should be replaced immediately (Fig 13 - B).

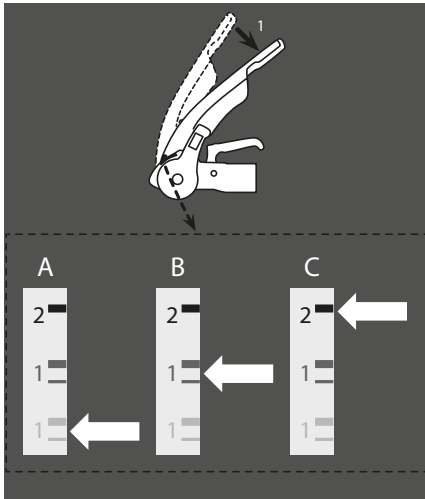

Figure 13 - Checking left / right friction pads

Note: When the stabiliser lever is correctly applied, the arrowhead should line up with the black line marked 2 (Fig 13 - C).

Note: The friction pads do not require any form of lubrication and should be cleaned with a fine emery paper prior to every journey. It is not necessary to adjust the friction pads.

Friction pad replacement (side)

(Replace one at a time)

1. Uncouple the AKS 3004 stabiliser.
2. Remove protective caps (see Fig 14 below - Item 1) with the aid of a small screwdriver.
3. Press worn out pad inwards and remove (use punch and hammer) (Fig 14 - Item 2).
4. Insert new friction pad from below (after first re-inserting shim washers if they were present) and press in as far as it will go (Fig 14 below - Item 3 and Fig 15).

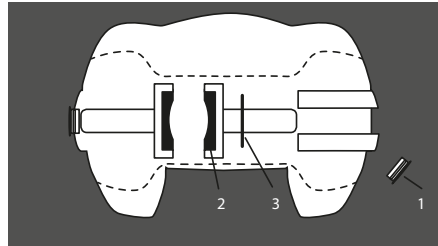

Figure 14 Remove worn pads

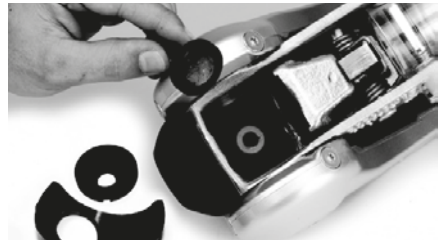

Figure 15 Insert new pads

AL-KO 3004 STABILISER

Checking the efficiency of the front/rear friction pads

1. Couple the AKS 3004 stabiliser to the towball but do not activate the stabiliser.
2. If a green indicator is visible (on the handle), then the AKS 3004 is in a new condition or the pads and towball are within the permissible limits (Fig 16 - Item 2).
3. If only a red indicator is visible (Fig 17 - Item 3), then this may have the following causes:
 - a. AKS 3004 is okay but the towball has reached the lowest limit of 49.61mm.
 - b. AKS 3004 stabiliser shows signs of wear.
 - c. Towball is in a new condition (50mm) but the front/ rear friction pads show a high degree of wear.

Establish the diameter of the towball so that conclusions may be drawn as to the wear of the friction pads (ball diameter must not be less than 49.61mm).

Friction pad replacement (front/rear)

1. Uncouple the AKS 3004 stabiliser.
2. Remove the soft dock (pull up & off), (Fig 20 - Item 1).
3. Press the safety indicator outwards and secure with SW14 hex. spanner (not included), (Fig 20 - Item 2).
4. Remove cheese-head screw (Fig 20 - Item 3 & Fig 18), using special torx tool.
5. Press friction lining recess (Fig 20 - Item 4) inwards and pull down and out.
6. Open coupling handle (Fig 20 - Item 5).
7. Remove countersunk head cap screw using special torx tool (Fig 20 - Item 6 & Fig 19).
8. Press friction pad inwards with a screwdriver and remove.
9. Fit new friction pads in reverse. Tighten screws to 5Nm (Fig 20 Items 3&6)
10. Replace rubber soft dock, insert top section then bottom.

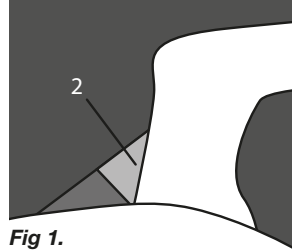

Fig 1.

Figure 16 Wear indicator - good condition

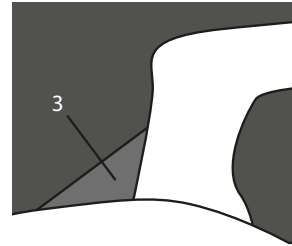

Figure 17 wear indicator - poor condition



Figure 18 cheese head screw revealed



Figure 19 Remove head cap screw

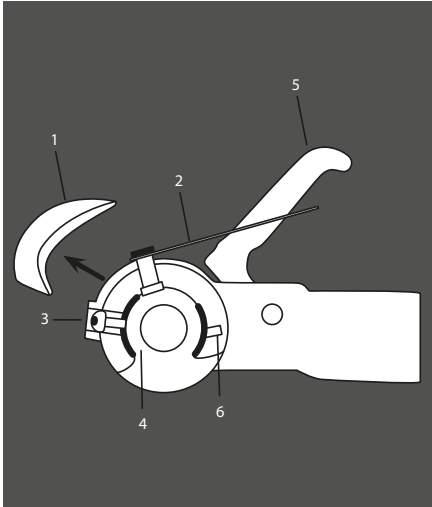

Figure 20 Friction pad revealed

Important maintenance & cleaning advice

1. The towball should be cleaned regularly to remove grease or other residue, to maintain the efficiency of the friction pads. The use of thinners, white spirit or brake cleaner is recommended for cleaning the towball and friction pads.
2. If friction pads are contaminated, they should not be cleaned but replaced.
3. The surface of the towball must be free of grooves, rust or seizing marks.
4. Towballs coated with paint or similar, must have this surface completely removed (use 100 or 120 grain emery paper). If this is not done, increased towball wear will occur and may cause damage to the AKS 3004 stabiliser components.
5. In winter, you should carefully spray only the visual indicator with de-icer.

Lubrication

Should lubrication of the stabiliser parts become necessary, then the following must be observed.

- a. Clean all parts thoroughly.
- b. Areas may only be covered with a thin film of grease (Fig 21).
- c. Use multipurpose grease DIN 51825 KTA 3K.

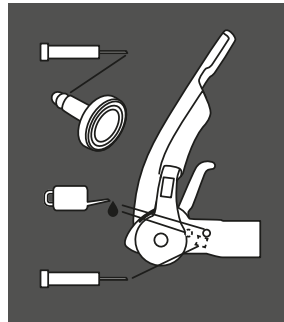

Figure 21

⚠ WARNING: When lubricating, ensure none gets into the friction pad or towball holding area.

FAQS

Stabiliser

Can the red and/or green indicator buttons be replaced if broken/missing?

This is usually caused by catching the button with the hitch lock when fitting the hitch lock. The green section can in some circumstances be replaced. Please contact AL-KO for further advice. The red part cannot be replaced.

The stabiliser arms keep lifting up when I travel. The most likely cause is the handbrake handle catching on the stabiliser lever when braking.

Gently tease the handle away from the contact point - 5mm should be sufficient. Whilst doing this, make sure you support the base of the handbrake with a block of wood to stop it coming off the ratchet plate.

FRICTION PADS/TOWBALL

Friction pads

When should I change my friction pads?

The friction pad life expectancy is around 30,000 miles and can be prolonged by regular cleaning with fine grade emery paper. Simply remove them according to the instructions (see Servicing and Cleaning) clean them and replace.

However, they will wear out and this can be monitored via wear indicators on your stabiliser. See page 250 for wear indicator information, and instructions on changing them.

My friction pads look 'glassy' with bits flaking off. Contamination has built up on the pads. This could be due to grease on the towball, spray from the road, diesel fumes or failure to remove all of the coating on the towball.

You need to remove the friction pads according to the instructions on page 250, and rub them lightly with a fine grade emery paper. AL-KO recommend cleaning the pads in this way after every journey to prevent build up and prolong friction pad life.

When towing I can hear loud creaking or groaning. There are two possible causes:

1. The incorrect towball could be fitted.
Check your towball is compatible with your stabiliser, and if it isn't replace it immediately. Failure to do so could result in your caravan becoming unhitched during towing.

The necessary clearances are outlined on page 244, and AL-KO recommends the AL-KO extended neck towball which complies to all the necessary specifications.

2. Contamination may have built up on the friction pads. This could be due to grease on the towball, spray from the road, diesel fumes or failure to remove all of the coating on the towball.

You need to remove the friction pads according to the instructions on page 250 and rub them lightly with a fine grade emery paper.

AL-KO recommend cleaning the pads in this way after every journey to prevent build up and prolong friction pad life.

The end has snapped off of my friction pad. This usually happens when the pads have not been fully disengaged before

dropping the stabiliser onto the towball. You will need to replace the friction pad with a new one. To avoid this in future always place, rather than drop, the stabiliser onto the towball and ensure the stabiliser lever has been lifted fully.

Can I tow my caravan without activating the friction pads? Yes, but AL-KO do not recommend it. It is the hitch handle that attaches the stabiliser to the towball. If you do not activate your friction pads then you will have no damping benefits.

Towball

My towball has grease on it. Can I use it with an AKS stabiliser? Under no circumstances can a greased towball be used with an AKS stabiliser. Ensure you remove all grease before hitching up.

Use a cloth to remove the excess grease, and use brake cleaner to remove any residue. We do not recommend methylated spirit as this can leave a greasy residue.

I have an AKS 3004 stabiliser. What is the minimum clearance that I need between the towball and towing vehicle? Minimum clearance is 68mm. This measurement is taken from the centre of the towball to the nearest point of contact with the towing vehicle.

Insufficient clearance will prevent the stabiliser from correct articulation and could damage your car or even cause the stabiliser to become detached from the towball.

Which towballs are compatible with the AKS 3004 stabiliser? The necessary clearances are outlined on page 244, and AL-KO recommends the AL-KO extended neck towball which complies to all the necessary specifications.

The AL-KO extended neck towball is available to purchase online at www.al-ko.co.uk.

OVERRUN DEVICE

I have a new AL-KO towball - do I need to take the paint off?

Yes. It is vital that all paint is removed from the towball before use, as it will contaminate the stabiliser friction pads.

To remove the paint, simply rub with emery paper, ideally finishing with a coat of brake cleaner fluid to remove any residue.

Overrun Device

In the importance of safety, please familiarise yourself with the operation of this overrun device BEFORE using your caravan.

Safety Precautions

When parking your tow vehicle and caravan on site, you must apply the caravan handbrake. If the unit is parked but disconnected from the tow vehicle, it is strongly recommended that each wheel is chocked using AL-KO or suitable wheel chocks.

Caution: Please note when parking the caravan/trailer, the wheelbrake auto reverse mechanism will allow the caravan/trailer to travel backwards for approximately 25 cm (please allow sufficient clearance when parking).

Operation

AL-KO overrun devices are a mechanical type, using a hydraulic damper.

Breakaway Cable

- Thread the breakaway cable through the breakaway cable guide provided (Fig 2) and connect it to attachment point provided on towing bracket (Fig 1). Please refer to 'Braked Trailers Use of Breakaway Cables' for further details.



Figure 1 Breakaway Cables.

Caution: The breakaway cable operates the handbrake (emergency brake), in the event of the caravan becoming detached from the towing vehicle during towing. For this emergency brake to work correctly, it is absolutely essential that the following points are observed:

1. The breakaway cable MUST run through the breakaway cable guide.
2. The breakaway cable MUST NOT be wrapped around the jockey wheel, as this disables the emergency brake (Fig 3).
3. The cable MUST run as straight as possible and not be restricted.
4. Ensure the cable is long enough to allow for cornering and will not become taut or snag during use, as this could result in the handbrake operating whilst towing.

Please refer to 'Braked Trailers Use of Breakaway Cables' information sheet, supplied with your caravan.

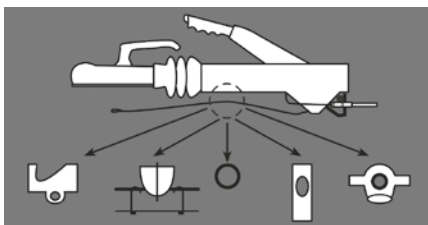

Figure 2 Breakaway Cables Guides.

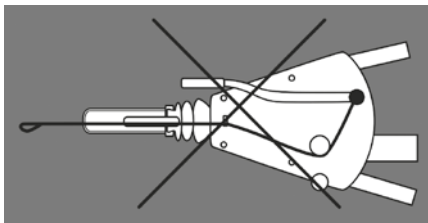

Figure 3 DO NOT wrap breakaway cable around jockey wheel.

OVERRUN DEVICE /
CHASSIS SERVICING AND CARE

EURO-OVERRUN DEVICES FITTED WITH AKS 3004 STABILISER

Fully retract Jockey Wheel inner tube so that it locks against Jockey Wheel outer tube.

Slacken Jockey Wheel Clamp handle and raise complete assembly through cutout in body to its highest position (ensure it doesn't come into contact with the brake rod assembly), fully tighten Jockey Wheel Clamp handle to ensure the Jockey Wheel is firmly held in position.

Euro Handbrake

Ensure the handbrake is fully applied to ensure that the wheel brakes will be automatically re-applied should the vehicle start to roll backwards.

Caution: If the handbrake is not fully applied as detailed above, there is a danger that the caravan could roll backwards.

To release

Press the handbrake down until it is parallel with the fairing cover to ensure that the brake is correctly disengaged.

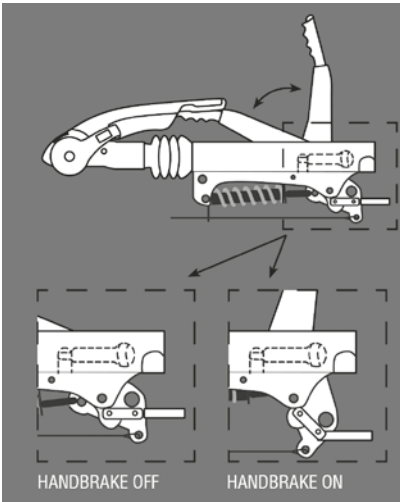

Figure 4 Handbrake lever operation

SERVICING

Every 10,000 - 15,000 km or every 12 months: Lubricate/grease all sliding and moving parts of the overrun device as show in Fig 5.

Recommended lubricant:- General purpose grease to DIN 51825 KTA 3KA.

CHASSIS

Servicing and care of hot dip galvanized parts:-

The formation of white rust is only a surface coating and has no adverse effect on the anti-corrosion properties of galvanising. To minimise the potential for the formation of white rust the following precautions should be taken:

- Ensure there is adequate air circulation when storing hot dip-galvanized parts.
- After winter journeys it is recommended that surfaces are washed with clean water.

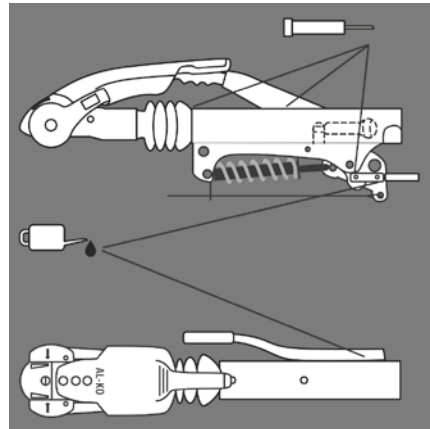

Figure 5 Lubricate/grease the parts indicated.

SPARE PARTS

Spare parts are safety critical parts! For this reason when fitting spare parts in our products we recommend the use of original AL-KO parts or those parts that we have explicitly approved. The reliability, safety and suitability of parts designed especially for our products, has been determined using a special test procedure. In spite of constantly monitoring the market we are unable to assess or vouch for other products.

If repair work or servicing is required, AL-KO have a large network of AL-KO service stations throughout Europe. To establish the correct spare parts required you should always quote the model and type of overrun device in question along with the ETI No. which is stamped into the overrun device housing. The ETI number for the Euro Overrun can be found on the handbrake lever.

Complementary products

AL-KO Security Device

AL-KO Security Devices provide a substantial deterrent against the theft of the caravan or trailer. They lock over the coupling handle, preventing unauthorised uncoupling.

Fitting the supplied Safety Ball into the coupling head when the Security Device is applied, prevents the caravan or trailer from being coupled to another vehicle.

The Security Device is manufactured from high density steel and is TUV approved. Visit www.al-ko.co.uk for more information.

Friction pads

Made from low-wear material, four specially engineered friction pads surround the towball and continue to ensure optimum friction damping.

Extended neck towball

Designed especially for use with the AL-KO AKS stabilisers the Extended Neck Towball has an extended machined neck to allow correct stabiliser articulation and clearances.

Hitch cover

Designed to fit the AKS 3004 Stabilisers, the hitch cover will help protect your stabiliser from the elements.

The water/fade resistant padded foam fabric has a velcro fastening and eyelet for padlock security (padlock not included). Visit www.al-ko.co.uk for more information.

Trouble shooting & fault finding**Table 1 Axles**

Fault	Cause	Remedy
Poor Braking	Linings worn or damaged. Brake Linings not bedded in. Brake set up incorrect.	Replace Brake Linings. Will pass after braking a few times. Reset Brakes as page 241 - 243 ensure system is lubricated.
Difficulty in Reversing	Braking system set too tightly. Auto-Reverse lever too stiff.	Reset Brakes as page 241 - 243. Lubricate and free off Reverse Lever.
Brakes Overheating	Incorrect setting. Braking system not fully released. Overrun lever stuck. Damage or Corrosion to braking system	Reset Brakes as page 241 - 243. Check Handbrake has been released & the system is running freely. Lubricate and free off Reverse Lever. Check system as page 241 - 243 and repair or renew parts as necessary.
Handbrake Force Low	Incorrect setting of the brakes. Linings not bedded in.	Reset brakes as page 241 - 243 and lubricate as necessary. Will pass after braking a few times.
Uncomfortable ride or Uneven Braking	Loose braking adjustment. Damper defective. Axle shock absorbers defective.	Reset brakes as page 241 - 243. Check and replace damper if necessary. Replace shock absorber.

Table 2 Coupling Heads

Fault	Cause	Remedy
Coupling does not engage onto ball	Ball diameter too large. Ball could be damaged or deformed. Coupling head dirty or defective.	Change ball to correct size. Fit new ball. Clean & Lubricate coupling and replace if necessary.
Difficulty in Uncoupling	Ball damaged or deformed. Coupling damaged or deformed. Coupling head under pressure from damper.	Fit new ball. Replace if necessary. Pull forward a few inches to relieve pressure
Too much play in the coupling	Coupling damaged or deformed Ball too small	Replace if necessary. Fit new ball.

Table 3 Overrun Devices

Fault	Cause	Remedy
Poor Braking	Overrun shaft tight. Overrun shaft corroded. Body housing damaged.	Lubricate overrun shaft and replace any damaged parts.
Brakes Overheating During Towing	Handbrake not fully released. Braking system incorrectly set. Incorrect attachment of breakaway cable.	Release handbrake. Reset brakes as page 241 - 243. Ensure correct attachment as listed on page 22 or refer to Braked Trailers Use of Breakaway Cables sheet.
Handbrake Force Low	Defective gas strut. Incorrect setting of spring cylinder.	Replace gas strut. Reset spring cylinder as page 241 - 243.
Brakes Apply During Deceleration or Downhill Travel.	Overrun damper is defective.	Replace the overrun damper.

CHASSIS ACCESSORIES

Accessories**Corner Steadies**

Corner Steadies are as stated, for the purpose of steadying the caravan corners. They are NOT JACKS AND SHOULD NEVER BE USED AS SUCH. The screw and pivot pins should be lubricated periodically to ensure their satisfactory operation. (See also Jack Operation).

Shock Absorbers

All AL-KO chassis have pre-punched holes to accommodate Shock Absorbers, in front of the axle. On the Euro-Axle System, axle swing arms have a removable rectangular plastic cap exposing a slot to accommodate retro-fit brackets for the Octagon Shock Absorbers. Delta Axles have Shock Absorbers fitted as standard which MUST NOT BE REMOVED.

Road Wheels

The condition of wheels and tyres should be checked regularly, particularly for distortion of flanges and the wheel dish. Wheels that are damaged or distorted, or have wheel bolt seatings cracked or deformed must not be repaired or used in service - these must be replaced.

⚠ WARNING: The torque settings should be re-checked regularly.

Jacks

The Corner Steadies Should never be used to jack up the caravan. When jacking becomes necessary use the AL-KO Side Lift Jack or 2-Tonne Jack system.

Note: It is essential that the car and caravan are hitched together before commencing jacking. All AL-KO chassis from 1992 onwards have 2 holes punched in the chassis members, each side (rear of the axle); to accept the brackets for the Jack(s). Corner Steadies may be used for stability ONLY, when the caravan is in the jacked position. The caravan should never be lifted by jacking up under the chassis member.

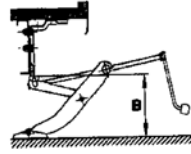
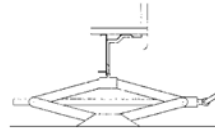
**Side Lift Jack****2 Tonne Jack**

If working under the caravan in an elevated position, axle stands must be used for safety. Wheel chocks for the opposite wheel(s) are also advisable.

Jockey Wheel

Lubricate screw thread and wheel spindle periodically.

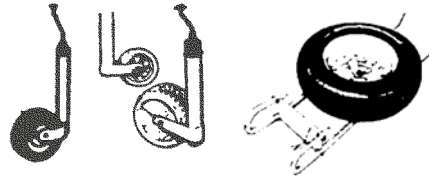
**Spare Wheel Carriers**

The telescopic frame tubes should be lubricated periodically.

USEFUL INFORMATION

Owners Club	260
Spares and after sales Supercare	260
Repair facilities	260
Caravan Clubs	261
Motoring Associations	261
Trade Association	261
Change of ownership	262
Index	266

USEFUL INFORMATION

Owners club

The Owners Club is a completely independent organisation run for the benefit of the caravan owners. They have numerous rallies during the year in various parts of the country. Apart from the friendliness and companionship the Club generates it is also actively engaged in charity work for those less fortunate than ourselves.

The address of the Secretary of the Owners Club can be obtained from the Swift Group website.

Spares and after sales

A catalogue of spare parts are available through our Swift Group Dealer Network, from door catches through to spare wheels. Please note, all parts enquiries must be directed through your dealer, as the Swift Group does not operate a direct retail service.

We endeavour to supply parts for vehicles up to 8 years old. If the original part is no longer available your dealer should be able to source a suitable alternative.

Note: Please remember to quote chassis number when ordering any items from your dealer.

Repair facilities

Should you be unfortunate to encounter damage to your vehicle, we have a number of approved workshops and dealerships with workshop facilities to undertake such repairs. Details of which can be found via our website: www.swiftgroup.co.uk/find-a-dealer

The enjoyment of caravanning can be greatly enhanced by membership of one or more of the various caravanning, motoring and holiday clubs. Here are some useful addresses:

Caravan Clubs

The Caravan Club

East Grinstead House,
East Grinstead
West Sussex, RH19 IUA

Tel: 01342 326944
www.caravanclub.co.uk

The Camping and Caravanning Club

Greenfields House,
Westwood Way,
Coventry,
West Midlands.

Tel: 024 7647 5448
www.campingandcaravanningclub.co.uk

Motoring Associations

Automobile Association (AA)
Fanum House,
Basingstoke,
Hants. RG1 2EA

Tel: 08705 448866
www.theaa.co.uk
e-mail: customer.services@theaa.com

RAC Motoring Services

8 Surrey St.
Norwich
Norfolk
NR1 3NG

Tel: 01922 437 000
www.rac.co.uk

Green Flag National Breakdown

Tel: 0845 246 1557
www.greenflag.com

RBS Insurance

West Moreland Road
Bromley, Kent
BR1 1DP
0800 051 3030

Trade Association

NCC

Catherine House,
Victoria Road,
Aldershot,
Hampshire, GU11 1SS

Tel: 01252 318251
www.thencc.org.uk
e-mail: info@thencc.org.uk

© 2016 SWIFT GROUP LTD

CHANGE OF OWNERSHIP

Change of ownership**Notification of change of ownership**

As the new second hand owner, please notify the Swift Group of the change of ownership by completing this page, detaching it and sending it to:

Customer Services Department
Swift Group Limited,
Dunswell Road,
Cottingham,
East Yorkshire,
HU16 4JX.

Note: Warranties are only transferable providing the terms and conditions of the warranty have been met by the previous owner(s). Please see warranty information at the beginning of this handbook for full details. The 'Extended Body shell warranty' is a non-transferable warranty.

CHANGE OF OWNERSHIP

Details of caravan:	Model:	
	Chassis No:	
New owner:	Name:	
	Address:	
	Email:	
	Telephone:	
	Mobile:	
	Date of purchase:	
Previous owner:	Name:	
	Address:	
	Email:	
	Telephone:	
	Mobile:	
	Date of purchase:	

Symbols

13 pin connection.....	73
13 pin socket.....	27
230V mains electrical equipment	74

A

Acrylic windows.....	222
AKS 3004.....	34
AKS 3004 hitchhead	25
Alarm awning light operation.....	50
Alarm siren	51
Alarm system.....	49
Alarm tilt sensor.....	50
Alde 3020 - 113 colour touch operating instructions	134
Alde Compact 3020 operating instructions.....	126
AL-KO accessories.....	258
AL-KO AKS 3004 stabiliser.....	244
AL-KO ATC trailer control system	234
AL-KO braking system adjustment	241
AL-KO chassis	234
AL-KO chassis troubleshooting.....	256
AL-KO complementary products	255
AL-KO operating instructions.....	49
AL-KO secure immobiliser	48
AL-KO side lift jack	49
ALKO Spare wheel and carrier tips	32
Appliance consumption figures.....	76
Arrival on site.....	33
Assistance.....	8
Awnings	210
Axle types.....	239

B

Barbeque point.....	195
Bathroom/shower care	229
Battery box.....	99
Battery installation	100
Bedding.....	199
Bonded roof	210
Breakaway cable	253
Breakaway cables	29
Bulb replacement and type.....	230

C

Caravan clubs	261
Caravan exterior	222
Caravan handling.....	31
Caravan interior	224
Caravan motor movers	18, 211
Caravan terms.....	14
Caravan towing code.....	14
Carbon monoxide.....	39
Care of laminate	209
CD/MP3/tuner with auxiliary input.....	198
Change of ownership	262
Changing a wheel.....	32
Chassis number	47
Children.....	39
Cleaning	222
Clubs and trade bodies	261
CO alarm.....	39
Colour reference.....	210
Condensation	223
Cycle racks.....	211

- D**
- Dometic absorption refrigerator 145
 - Dometic C600 oven..... 177
 - Doors 209
 - Doorscreen..... 201
- E**
- Electrical overseas connection..... 72
 - Electrical system..... 72
 - Escape paths 38
 - Exterior 230v socket..... 102
 - Exterior door..... 34, 201
 - Exterior door key 201
 - External entertainment point 199
 - External shower point 196
- F**
- FENIX work surfaces 227
 - Fire alarm test..... 37
 - Fire and fire alarm 36
 - Fire extinguisher 38
 - Front locker and sunroof..... 210
 - Furniture care 229
- G**
- Galvanised steel chassis..... 22
 - Gas 67
 - Gas bottles..... 67
 - Gas cylinder changing 70
 - Gas faults 71
 - Gas hoses 67
 - Gas regulator..... 67
 - Gas safety advice 69
- Gas schematic 66
 - Generator 102
 - Glossary & checklist 17
 - Green Flag National Breakdown 261
- H**
- Habitation relay..... 102
 - Hand brake 239
 - Heki-2 roof light 205
 - Heki 4 remote control 206
 - Heki care instructions 203
 - Heki midi rooflight..... 204
 - Heki mini rooflight 203
 - HI-MACS solid surface worktop..... 226
 - Hitching-up..... 24
- J**
- Jacking points 33
- L**
- Lift-up bunks 200
 - Loading 239
- M**
- Measurement of nose weight..... 16
 - Microwave oven 186
 - Mirrors..... 30
 - Modifications 222
 - Motoring associations..... 261
 - Motorway driving..... 31
 - Moving off 31
 - MPK rooflight..... 207
- N**
- NCC..... 261

O

Omni-vent	212
Overrun device	253
Owners club	260

P

PIR internal movement sensor	50
Plumbing connections	59
Plumbing troubleshooting	60
Preparing for the road.....	20
Pressure switch adjustment.....	61
Pre-tow check list.....	24

R

RAC motoring services.....	261
RBS Insurance	261
Rear view camera.....	213
Repair facilities.....	260
Reversing	31
Roller blind advice	202

S

Security	47
Security chips.....	47
Sensor cleaning.....	61
Service brake	239
Service doors	219
Service inspection	10
Shower heads	210
Smoke alarm operation	36
Snaking	22
Solar energy system (when fitted)	101
Spares and after sales customer care....	260
Speed limits.....	31
Stabiliser friction pads.....	22
Stability.....	22
Stainless steel bowl care	229
Step on hitch cover	211

Stopping on a hill.....	33
Suitable towing vehicles.....	22
Supplier contacts	9
Swift Command app.....	96
Swift Command control panel.....	80
Swift Command power control system	78
Swift Command Tracker by Sargent	47
SwiftShield fabric	225
Swift Talk.....	2

T

Tables.....	209
Table storage.....	209
Thermal insulation heating	70
Thetford Aspire 2 cooker	172
Thetford C260 cassette toilet.....	188
Thetford Caprice cooker	169
Thetford mini grill	166
Towball	22
Tow car electrics.....	28
Towing vehicle's rear suspension	21
Towing vehicle terms	16
Trade association.....	261
Truma combi boiler	106
Truma CP Plus digital timer control	107
Truma heating system and air flow.....	107
TV inlet in battery box.....	197
Types of gas	69
Types of tyres fitted.....	22
Typical gas schematic drawing	66
Tyre maintenance	23

U

USB socket	103
Useful memory aid.....	19

V

Ventilation..... 46

W

Warranty..... 6

Water faults 64

Water (fresh) level sensor & cleaning 61

Water intake housing 62

Water pump pressure switch adjustment . 61

Water system 54

Water system no internal water tank..... 55

Water system - priming no internal
water tank 55

Water system - priming with tank..... 58

Water system sanitising 63

Water system with water tank..... 56

Water tank types 55

Wheel bolt tightening 32

Windows 202

Winterisation..... 231

Wiring of connecting cable and
caravan mains inlet..... 75

USEFUL INFORMATION



All Swift Group models have been certified by the National Caravan Council for compliance with stringent European Standards, British Legislation and industry set Codes of Practice specifically relating to health and safety issues.

The approval process covers the testing and inspection of critical areas of the product from fire safety, weights and dimensions, to gas, electrics and ventilation. Every caravan carries the "NCC Approved Caravan" badge.

The NCC also conduct unannounced inspections at the Swift factory to ensure continued compliance. NCC Approval gives you peace of mind that your caravan is legal and safe.

All Swift Group touring caravans are European Whole Vehicle Type Approved.

This is your assurance that these caravans meet all European regulations, and have been constructed and conform to approved standards of safety and manufacturing.

IMPORTANT CUSTOMER NOTICE

TOURING CARAVAN MODEL YEAR

The model year runs from 1st September to 31st August.

For example, the earliest a 2016 model would be registered under the Caravan Registration Identification Scheme (CRiS) is 1st September 2015.



CRiS is the Central Registration & Identification Scheme that issues touring caravan registration documents, equivalent to that of the V5 registration document issues by the DVLA for cars. CRiS was established in 1992 by The National Caravan Council and provides a method of registering the "keeper" details of every tourer manufactured by NCC member companies to help prevent and detect caravan related crime.

Why register with CRiS?

- Safety • Security • Warranty

Did you know..?

You should not take a tourer abroad without a registration document. If you go abroad your CRiS registration certificate provides the necessary proof, required by the police and other authorities, that you are its registered keeper.

If you need to make a claim on your insurance, CRiS can help speed up claims by providing details of your tourer and its purchase date to relevant parties.

CRiS can help your tourer's manufacturer contact you in the event that there is any kind of product recall or fault that could affect the safety of your caravan.

CRiS Registration and VIN Chip Caravan Registration

Your caravan has been security marked and recorded under the Caravan Registration and Identification Scheme that is recognised by the Caravan Industry.

Shortly after purchasing this caravan you should receive your Touring Caravan Registration Document. It will be sent by post to you home address.

Your Touring Caravan Registration Document will include a 17 character VIN (Vehicle Identification Number), shown in the top right hand corner. This 17 character will be permanently marked onto the caravan chassis.

To protect yourself and your touring caravan, never leave the Registration Document in the caravan. For security reasons keep it in a safe place.

If you sell the caravan please follow the instructions on the Touring Caravan Registration Document.

If you do not receive a Touring Caravan Registration Document, lose it, or any of the details recorded are incorrect, please contact: CRiS, Avonbridge House, Bath Road, Chippenham, Wiltshire, SN15 2BB or Tel 0203 282 1000.

VIN Chip Caravan Identification

The caravan's unique 17 character VIN will be incorporated into VIN Chip tamper evident labels; the master VIN Chip label is situated on the front near side window to aid police checking, another in the gas locker and a maximum of 10 placed on the inside of the windows (with the exception of opaque windows).

Three electronic RFID chips containing the individual identity of your caravan are concealed within the caravan and can only be read by using a specially programmed RFID scanner.

Your local police can obtain the use of a CRiS VIN Chip scanner by contacting CRiS on Tel 0203 282 1000.

For help, support and advice Contact CRiS:

NCC CRiS Ltd
PO Box 445
Aldershot
GU11 9SF

Tel 0203 282 1000

www.cris.co.uk

Opening Hours: Monday - Friday 8am to 8pm
Saturday 9am to 5pm
Sunday 10am to 5pm