

## INTRODUCTION

### Dear owner

Thank you for deciding to buy one of our new motorhomes.

We are sure you will enjoy many happy hours in it and we hope the information and hints in this handbook will heighten your enjoyment.

The handbook has been designed to give you a general guide to the care, use and maintenance of your caravan. Whether you are a new or an experienced motorhomer the hints will help to protect your investment.

The information contained will answer most of your queries, but if there are any aspects which are not covered please consult your appointed dealer. We would suggest you make a note of your dealers name and contact information below.

Dealer Name:

.....

Telephone Number:

.....

E-mail:

.....

**IMPORTANT - please quote the base VIN (Vehicle Identification Number) in all correspondence with your dealer or Swift Group limited, this can be found on the front windscreen and on the plate of the front cross member within the engine compartment and on the swift manufacturers plate situated on the bulkhead directly behind the front driver/passenger seat.**

All the illustrations and descriptive matter in this handbook are intended to give a general idea of the motorhome. Changing market and supply situations may prevent us from maintaining the exact specification details in this handbook. We therefore reserve the right to alter specifications as materials and conditions demand.

Dealers are not agents of Swift Group Limited and have absolutely no authority to bind Swift Group Limited by any express or implied undertaking or representation.

# Introduction

## SWIFT TALK

Swift Talk is the new central forum for the Swift community online. A place for all those united in their love of caravanning, motorhomes, holiday homes and touring in general, to share their experiences, meet new friends and find out a world of information on how to enjoy their touring lifestyle.

The site is packed full of features that actively encourage members, not only to liaise with the Swift Group via the forums, but also interact with each other through publishing their own content, uploading and sharing photos and video, and even posting their own blogs for the community to follow.

Swift Talk is the first place to learn about new product launches, events and Swift Group news, it's also the first place customers can go to as a quick reference to frequently asked questions or to actively take part in the forums; providing valuable feedback on Swift Group products and customer service.

The new online community can even be used to create your own groups, perfect for Owners' Clubs, dealers and exhibitors to attract new members, publicise and build awareness for upcoming events, rallies and shows.

Anyone who owns, uses, or is thinking of buying a Swift Group caravan, motorhome or holiday home, or would just like to be part of the growing Swift community is actively encouraged to sign up, create their own content, and start talking!

**Just visit [www.swift-talk.co.uk](http://www.swift-talk.co.uk) and become part of a unique online experience.**

# CONTENTS

<b>WARRANTY</b> .....	<b>1</b>
<b>MOTORHOME CODE</b> .....	<b>9</b>
<b>PREPARING FOR THE ROAD</b> .....	<b>13</b>
<b>'EN ROUTE'</b> .....	<b>21</b>
<b>SAFETY &amp; SECURITY</b> .....	<b>25</b>
<b>ARRIVAL AT SITE</b> .....	<b>31</b>
<b>CONNECTING SERVICES</b> .....	<b>33</b>
<b>ELECTRICAL SYSTEMS</b> .....	<b>51</b>
<b>EQUIPMENT DETAILS</b> .....	<b>69</b>
<b>MOTORHOME CARE</b> .....	<b>159</b>
<b>USEFUL INFORMATION</b> .....	<b>167</b>



# WARRANTY

- Warranty . . . . . 2**
- Assistance . . . . . 4**
- Your warranty explained . . . . . 5**
- Supplier contacts . . . . . 5**
- Annual service / inspection record . . . . . 6**
- Annual service / inspection record Stamps . . . . . 7**

# Warranty

## WARRANTY

All the illustrations and descriptive matter in this handbook are intended to give a general idea of the motorhome. Changing market and supply situations and our policy of continuous product development may prevent us from maintaining the exact specifications detailed in this handbook. We therefore reserve the right to alter specifications as materials and conditions demand.

Dealers are not agents of Swift Group Limited, the manufacturer of Swift Group motorhomes and have absolutely no authority to bind the manufacturer by any express or implied undertaking or representation.

All motorhomes (other than the engine, chassis cab and associated parts referred to in this handbook which are subject to the relevant chassis manufacturer's warranty) have a 3 year SuperSure manufacturer's warranty from the date of purchase (or hire purchase), which is subject to a chargeable annual service and inspection being carried out at an authorised Swift Group Service Centre.

During the warranty period, subject to the exclusions set out in this section of the handbook, the manufacturer, Swift Group Limited, will repair (or at its option, replace) all defective parts of the motorhome. For any engine, chassis cab and associated parts warranty issues please contact your local Fiat/Peugeot Agent.

The manufacturer will honour the warranty until 36 months from the date of sale, provided that the motorhome has been serviced annually within 90 days before or 60 days after each anniversary of the original date of sale. The third service must, however, be carried out before the expiry of the 36 month period from the original date of sale.

### **In the first 12 months the warranty will cover:**

Faults arising from a manufacturing defect but not those which are a result of normal wear and tear or those which relate to replacement light bulbs and leisure battery.

Also not covered under the first year are faults resulting from accidental damage or damage caused by misuse of any component part of the motorhome.

### **In the years two and three the warranty will cover:**

1. Water system; heater, fresh water tank, water pump, water gauges, taps and shower heads
2. Heating system and components
3. Main proprietary items ie. fridge, toilet, cooker
4. Chassis and associated parts
5. Auxiliary electrics

6. Windows, excluding window furniture and blinds

### **In years 2 and 3 the warranty will specifically exclude:**

- All soft furnishings
- Audio equipment
- Microwave

### **General terms applying to all three years of the warranty period**

The motorhome is not covered for:

- The failure of a component for reasons of fair wear and tear.
- Damage resulting from accidents.
- Misuse of any component.
- Normal deterioration, corrosion, intrusion of foreign or harmful bodies, lack of servicing or negligence of any person other than the Swift Group Limited which causes stoppage of or impairment to the function of any component of the motorhome.
- Replacement of parts which have reached the end of their effective working life because of age and/or usage.
- Cleaning or adjustment of any assemblies.
- Cosmetic finishes to kitchen sinks, cooker tops, vanity units, shower trays.

- Routine maintenance items which are part of the annual service including lubricants, rubber gas hose, the cleaning of the heater and fridge flues, the replacement of gas jets, the resealing and/or replacement of shower room sealant, and the adjustment and lubrication of locks.

The warranty will be invalidated if the motorhome has been neglected, misused, modified or for hire or reward. The motorhome will be deemed to have been neglected if it has not been serviced and maintained as stated in this handbook.

If any repairs are identified as being necessary during an Annual Service, the motorhome must be made available to an authorised Swift Group Service Centre within 6 weeks for the work to be carried out. All new motorhomes must be registered with the Swift Group Ltd within 6 weeks of purchase as new.

The warranty only applies to motorhomes purchased and used within the UK, and for continuous journeys abroad of no longer than 90 days per journey.

The cost of transporting, towing or moving the motorhome by any means to or from the place of repair is the responsibility of the owner.

The benefit of this warranty may be transferred to a new owner if the motorhome is sold, provided that the motorhome has been serviced by an authorised Swift Group Service

Centre in accordance with the requirements of this handbook, and details of the change of ownership have been supplied to Swift Group using the change of ownership form set out in this handbook. Failure to notify Swift Group of a change of ownership within 14 days of such a change will invalidate the warranty.

### **This warranty only applies to motorhomes purchased in the UK.**

You have legal rights under UK law governing the sale of consumer goods.

This warranty does not affect your legal rights.

The name and address of the warranty provider is:

Swift Group Limited  
Dunswell Road  
Cottingham  
East Yorkshire  
HU16 4JS

To make a claim under this warranty, contact the Swift Group Service Centre which supplied your motorhome. Alternatively, details of your nearest authorised Swift Group Service Centre can be obtained by contacting the Swift Group Customer Care Department on 01482 875740, or enquiring on the website [www.swiftgroup.co.uk](http://www.swiftgroup.co.uk)

# Warranty

## ASSISTANCE

### What to do if you Require Assistance

Congratulations on purchasing a Swift product. We are confident that you will enjoy many happy holidays. However, should you have an enquiry or require assistance with a problem, we hope that this guide will be of assistance to you.

### If you have a problem, or enquiry with regards to your new motorhome, please follow these steps:

1. Check the Owners Handbook, paying particular attention to the fault finding advice at the back of the book.
2. Contact your supplying dealer for assistance.

### If you need to contact the Swift Group, please be aware of the following:

1. When contacting Swift Supercare, please quote your name, postcode and build number of your motorhome.
2. In most instances, the Customer Care Team will involve your dealer in resolving the issue you are experiencing.
3. If you are contacting the company by email, letter or fax, the Customer Care Team will respond to you within five working days from the date of receiving the correspondence.
4. If you are calling the Customer Care Team, please avoid where possible, Mondays and lunch times.
5. Please be aware that the Swift Group cannot send parts direct from the factory. In all cases, without exception, your dealer must place the order for you.



## SUPPLIER CONTACTS

A number of Swift Group suppliers manage their own Technical and Warranty related queries. Where a customer has a question relating to a product manufactured by a company listed below, we would advise that the first contact should be directly with them.



### Sargent Electrical Services

Unit 39, Tokenspire Business Park, Beverley, East Yorkshire, HU17 0TB

Phone: 01482 678981

Fax: 01482 678987

E-mail: [support@sargentitd.co.uk](mailto:support@sargentitd.co.uk)



### AL-KO Kober Limited

South Warwickshire Business Park  
Kineton Road, Southam,  
Warwickshire, CV47 0AL

Fax: 01926 818562

Email: [mail@al-ko.co.uk](mailto:mail@al-ko.co.uk)



### Truma UK Ltd.

Park lane, Dove Valley Park,  
South Derbyshire, DE65 5BG

Phone: 01283 586020

Fax: 01283 586029



### Thetford Ltd.

Unit 19, Oakham Drive,  
Parkwood Industrial Estate,  
Rutland Road, Sheffield, S3 9QX

Phone: 0114 273 8157

Fax: 0114 275 3094

Email: [infogb@thetford.eu](mailto:infogb@thetford.eu)



### Alde International (UK) Ltd

Regent Park, Park Farm South,  
Wellingborough, Northants, NN8 6GR

Phone: 01933 677765

Fax: 01933 674975

Email: [info@alde.co.uk](mailto:info@alde.co.uk)

# Warranty

## **ANNUAL SERVICE / INSPECTION RECORD**

In order to comply with the warranty, you must have your motorhome inspected and serviced by an authorised Swift Group Service Centre at least once per year.

It is important that the owner's handbook is stamped on the appropriate page by the authorised Swift Group Service Centre.

Failure to do this will invalidate the warranty and the transfer of the warranty on the change of ownership.

The inspection should take approximately two hours and will cover the areas dealt with in the annual service check list. Any areas requiring service and/or maintenance will be highlighted by your dealer and we recommend that you authorise any necessary work to be carried out.

NB. It is essential, to validate the warranty, that an annual inspection be carried out by an authorised Swift Group Service Centre covering the items listed.

Just as the engine/gearbox/roadwheels need regular servicing by your chassis dealer, so there are components in your conversion that need regular maintenance by your motorhome dealer.

These include the gas and electrical systems and the seals in the bodywork. Your dealer will

complete the record in this handbook to show that the work has been carried out.

1. Damp and lamination test.
2. Chassis and chassis to body security.
3. Corner steadies.
4. Motorhome step.
5. Road lights, wiring and reflectors.
6. Internal lights and 12V DC system.
7. Water heater - gas and 230V AC.
8. Hob, grill and oven.
9. Refrigerator 230V AC, 12V DC and gas.
10. Gas system.
11. Water pump, taps and water system.
12. Mains 230V AC system.
13. Windows and fittings.
14. Roof lights.
15. Furniture hinges/stays etc.
16. Exterior locks and hinges.
17. All internal vents.
18. Seals.
19. Blinds and fly screens.
20. Blown air heating and gas fire systems.

**ANNUAL SERVICE /  
INSPECTION RECORD STAMPS**

Motorhome model .....

Registration number .....

Chassis number .....

Registration date .....

2nd SERVICE

DATE:

DEALER'S STAMP

We certify that an annual service has been carried out in accordance with the handbook.

4th SERVICE

DATE:

DEALER'S STAMP

We certify that an annual service has been carried out in accordance with the handbook.

1st SERVICE

DATE:

DEALER'S STAMP

We certify that an annual service has been carried out in accordance with the handbook.

3rd SERVICE

DATE:

DEALER'S STAMP

We certify that an annual service has been carried out in accordance with the handbook.

5th SERVICE

DATE:

DEALER'S STAMP

We certify that an annual service has been carried out in accordance with the handbook.

# Warranty

6th SERVICE

DATE:

DEALER'S STAMP

We certify that an annual service has been carried out in accordance with the handbook.

8th SERVICE

DATE:

DEALER'S STAMP

We certify that an annual service has been carried out in accordance with the handbook.

10th SERVICE

DATE:

DEALER'S STAMP

We certify that an annual service has been carried out in accordance with the handbook.

7th SERVICE

DATE:

DEALER'S STAMP

We certify that an annual service has been carried out in accordance with the handbook.

9th SERVICE

DATE:

DEALER'S STAMP

We certify that an annual service has been carried out in accordance with the handbook.

11th SERVICE

DATE:

DEALER'S STAMP

We certify that an annual service has been carried out in accordance with the handbook.

# MOTORHOME CODE

<b>Code of conduct</b> .....	<b>10</b>
<b>The Country code</b> .....	<b>12</b>
<b>The Coastal code</b> .....	<b>12</b>

# Motorhome Code

## CODE OF CONDUCT

### CAMP SITES

#### Arrivals

Report to reception immediately on arrival.

#### Vehicle Movement

Keep to roadways unless otherwise directed.

Adhere to speed limits. Note that these are generally 10 mph. (Remember that the stopping distance on grass is considerably greater than on tarmac.)

Only a person in possession of a current driving licence may drive on the site.

Park correctly as advised on your pitch. Where possible leave 20 feet of free space around your vehicle.

#### Use of Site Appliances

Use the electrical mains hook-up in the correct manner and with caution.

Ensure that all fresh water taps/connections are turned off after use.

Have care and consideration when using all facilities (toilets and showers etc) and leave clean and tidy. Young children should be supervised.

#### Waste Disposal

If the vehicle is not fitted with a waste water

tank, a suitable receptacle should be placed below all waste water outlet pipes. Do not let these containers overflow.

Dispose of all waste water where instructed.

Empty effluent from chemical toilets where instructed.

To avoid possible damage to sewage purification works, only approved chemical fluids must be used. Under no circumstances should coal tar, phenol or caustic-based fluids be used.

Disposable napkins and similar bulky items must not be put into chemical closet emptying points but should be wrapped in a polythene bag and placed in the container provided.

Place all litter in containers marked for the purpose.

#### Noise

Do not make excessive noise.

Children should be restrained from making excessive noise.

Flying kites and model aircraft and the use of items like catapults or air-guns, as well as ball games, should not be permitted among, or close to other vehicles.

Musical instruments, record players, radios and televisions should not be used to the

inconvenience of other people on the site.

Open and close doors quietly.

Power generators must be adequately silenced and used with consideration.

#### Dogs and other Pets

All dogs and other pets should be kept under control.

Unless permission has been granted, no animal should be allowed loose on the site and leads must not exceed 10ft.

No animals should be allowed in the shower/toilet blocks.

Do not let dogs foul the site.

#### Fire Precautions

Adhere to and take note of fire precautions noting the whereabouts of the fire points.

**WARNING: Provide one dry powder fire extinguisher of an approved type or complying with EN3, of at least 1kg capacity, by the main exterior door and a fire blanket next to the cooker.**

**Familiarise yourself with the operating instructions on your fire extinguisher and the local fire precaution arrangements.**

## Motorhome Code

When using a dry powder extinguisher it is suggested that the motorhome be evacuated until the powder has settled, to avoid inhalation.

Unless permission has been granted, barbecues should not be used. If permission is given, consideration should be given to the annoyance that can be caused to other users of the site.

Open fires are not allowed.

### **Awnings and Tents**

Awnings and tents should only be used when permission has been obtained.

When on grass and staying for more than a few days, the ground sheet and/or side flaps of awnings should be periodically raised in order to avoid damage to the ground.

### **Departure**

Leave the pitch clean and tidy.

On leaving, check out with reception paying the required fees.

### **WILD CAMPING**

Camping away from licensed sites, without the permission from the land owner or his agents, is not allowed in the United Kingdom.

When permission has been granted, all aspects

of this Code should be adhered to.

On no account should:

- (a) Litter be disposed of other than in the receptacles provided.
- (b) Water be allowed to escape from the vehicle.
- (c) Chemical toilets be emptied except into the disposal places agreed with the land owner.
- (d) Washing or similar be hung outside the vehicle.

### **PARKING**

Motorhomes should only be parked in approved places.

When using the facilities of a motorhome, care and consideration should be given to those around them.

### **DRIVING**

Before moving off, elevated rooflights and aerials should be lowered and correctly secured, and top hinged windows closed. Likewise all doors and access lockers for gas containers and chemical toilets must be properly secured.

Exterior steps should be properly retracted and secured.

When the vehicle is in motion it is compulsory for all front seat passengers and rear seat passengers to wear seat belts, where fitted.

When using a motorhome on either the public highway or private roads the Highway Code should be complied with and full consideration given to other road users.

In the event of a motorhome travelling slowly the driver of the motorhome should, where possible, pull over in order to let other traffic pass.

**When refuelling or on a ferry ensure the gas system is fully isolated at source.**

# Motorhome Code

## HANDBOOKS (CHASSIS & CONVERTER)

Before using a motorhome all aspects of the handbooks, produced by the chassis manufacturer and the converter, must be read and adhered to.

The separate chassis manufacturer handbook refers to your motorhome chassis and base vehicle including care and maintenance.

## ENVIRONMENT

Care and consideration should be taken to protect the environment.

Observe the Country and Coastal Codes.

## THE COUNTRY CODE

Enjoy the countryside but respect its life and work.

More people than ever before are exploring the countryside, interested in farming, plant life, bird watching or just observing the general wildlife. Whatever your interest, there is a lot to learn, but please observe the following code:

1. Guard against all risk of fires. Hay and heathland catch alight easily and once ablaze are very difficult to put out.

**REMEMBER: FIRE SPREADS QUICKLY.**

2. Fasten all gates.
3. Keep your dog under proper control.
4. Keep to the paths across farm land.
5. Avoid damaging fences, hedges and walls.
6. Leave no litter.
7. Safeguard water supplies.
8. Protect wildlife, wild plants and trees.
9. Go carefully on country roads.
10. Respect the life of the countryside.

## THE COASTAL CODE

As our coastlines are increasingly used for recreation and education, the following suggestions are made to enable us to enjoy our inheritance and preserve it for posterity.

### **Disturbance may mean DEATH.**

DO NOT trample about, or move rocks unnecessarily.

DO NOT frighten seals or seabirds.

DO NOT spill detergents, solvents or fuel from boats as these can kill marine life.

When sailing, moderate your speed - the wash from a fast boat can destroy banks and nests.

Live molluscs and crustaceans need not be collected as souvenirs - dead shells can usually be found.

Shellfish can take years to grow and fines can be imposed for not observing national regulations.

DO NOT pull up seaweeds unnecessarily.

Make your visit instructive - not destructive.

Look at material - don't remove it. Take notes and photographs, not specimens.

Observe by-laws and be considerate to others.

National Trust property and Country Parks have regulations to protect the wildlife. Follow these and the Country and Coastal Codes.



# PREPARING FOR THE ROAD

<b>Before moving off</b> .....	14
<b>Motorhome terms</b> .....	14
<b>Loading of vehicle</b> .....	15
<b>Large storage areas</b> .....	15
<b>Roof loading</b> .....	16
<b>Tyres</b> .....	16
<b>Dedicated travelling passenger seating</b> .....	16
<b>Child seats</b> .....	17
<b>Three point seat belts</b> .....	17
<b>Driving licence</b> .....	18
<b>Vehicle classifications</b> .....	18
<b>Advice on towing</b> .....	18

# Preparing for the road

## BEFORE MOVING OFF

### Check:

- all gas operated appliances have been isolated, except the heating system.
- gas cylinders are correctly positioned, secured and turned off unless using en-route heating.
- loose articles including Luton ladder are stowed securely. Do not stow tins, bottles or heavy items in overhead lockers.
- all lockers and cupboard doors are closed and secured.
- main table is stored or locked in its transit position.
- fridge is on 12V operation and door lock is set.
- 230V mains input socket flap is securely closed.
- all drain taps are closed.
- tyre pressures and wheel nuts.
- rear corner steadies are raised.
- exterior roof rack ladder is raised and secured.
- all windows/doors/rooflights are closed and secured.
- TV aerial is lowered and locked into position.

- exterior step (where fitted) is retracted/folded in.

Special attention must be taken to ensure all top hinged windows as well as the Luton windows and rooflights are closed when in transit. All units should be fully closed and latched to prevent damage. The motorhome exterior door should also be locked.

**The entrance door must be closed before the central locking is activated. Failure could result in being locked out of the vehicle if the keys are left inside.**

## MOTORHOME TERMS

### Mass in Running Order:

This is the mass of the motorhome as stated by the manufacturer, i.e. ex works weight including the driver with 90% fuel / fresh water / gas capacity and standard fixtures and fittings, in compliance with European Directive 92/21/EEC (Masses and Dimensions).

Note: Quoted MRO is subject to tolerance, due to weight variation of materials used in Motorhome construction.

### Maximum User Payload:

The maximum allowable weight to be put into the motorhome whilst it is being driven. This is made up of 4 sections:

Personal effects, conventional load, optional

equipment and essential habitation equipment.

The Maximum User Payload is the difference between the Maximum Technically Permissible Laden Mass and the Mass in Running Order.

### Personal Effects:

Those items which a user can choose to carry in a motorhome and which are not included as Essential Habitation Equipment or Optional equipment.

### Conventional Load:

A mass allowance for each designated passenger seat.

### Optional Equipment:

Items made available by the manufacturer over and above the standard specification of the motorhome.

### Essential Habitation:

A mass allowance for liquids in systems not accounted for within the MRO.

### Maximum Technically Permissible Laden Mass:

The maximum weight for which the motorhome is designed for normal use when being driven on a road, laden.

This mass takes into account specific operating conditions including factors such as the strength of materials, loading capacity of tyres etc.

## Preparing for the road

**WARNING: Under no circumstances should the axle loadings or the Maximum Technically Permissible Laden Mass of this motorhome be exceeded.**

### Nose weight:

The static mass of the trailer towing device on the rear of the towing vehicle.

### Notes:

- (i) When measuring the noseweight it is important that the trailer is loaded.
- (ii) The trailer is intended to be towed slightly nose heavy. The nose weight can be adjusted by distribution of the load. The nose weight should be approximately 7% of the actual laden weight (but not greater than the hitch capacity) and at the same time suit the motorhome requirements. See 'Advice on Towing' page 17/18.

## LOADING OF VEHICLE

**WARNING: Loads must not be exceeded. The driver is responsible for arranging the loads so that they comply with the technical weight limits of the specific motorhome model. See specification handbook.**

Correct weight distribution is an important factor in ensuring your vehicle is well balanced and easy to drive. It is therefore necessary to load your motorhome carefully making sure all heavy articles are evenly distributed and are preferably placed in the lower lockers or bed boxes.

**WARNING: The two longitudinal bars fitted to the roof are there for styling purposes only and should not be used for load carrying.**

**WARNING: Do not travel with televisions or microwaves in overhead lockers unless the appliance was supplied fitted to your motorhome by the manufacturer.**

Although it is essential to ensure that the total weight of your motorhome does not exceed the stipulated Maximum Technically Permissible Laden Mass, (MTPLM), it is important to remember that the front and rear axles also have individual maximum weights which must not be exceeded.

**To ensure adequate road holding the load on the front axle, under all conditions, must not be less than 40% or more than 70% of the total weight.**

Ensure you distribute the payload equally on each side of the vehicle to avoid an imbalance.

These weights, together with the MTPLM, can be found on the VIN (Vehicle Identification Number) plate located under the bonnet on the front cross member.

**Please take care to ensure you have allowed for the masses of all the items you intend to carry in your motorhome e.g. passengers, optional equipment, essential habitational equipment and personal effects such as clothing, food, pets, bicycles, sailboards, sports equipment etc.**

## LARGE STORAGE AREAS

The large storage areas provided in some motorhome layouts are designed solely for the purpose of carrying personal possessions, these areas must not be used;

- as a habitation area (eg living, sleeping or cooking).
- to carry passengers, animals or livestock.
- for the installation (or use) of any LPG gas operated appliances, (unless supplied fitted by the manufacturer).
- for carrying LPG gas bottle cylinders.
- to carry any flammable liquids, unless properly stored, sealed and secured.
- for the operation of an electrical generator.

## Preparing for the road

- in such a way that the load exceeds the MTPLM and maximum axle loads.

Care must be taken to ensure that exterior doors are closed, locked and that all possessions are properly stored and secured before setting off on any journey.

### ROOF LOADING

Some motorhome roofs can be fitted with a roof rack (optional).

A maximum load of 50kgs can be evenly distributed on the roof rack system. This figure **MUST NOT** be exceeded.

Note: When loading the roof rack, make sure the load is spread evenly and do not allow sharp objects to come into contact with the roof surface.

**Do not apply excessive load to the rear suspension of your motorhome or allow the vehicle to reverse with the roof rack access ladder in the down position, touching the ground. This may cause excessive strain on the ladder fixing points.**

The roof areas, up to the over cab section, are capable of withstanding an average person's weight (13 stone or 82.5kg).

Note: Do not walk on the over cab section.

**WARNING: the roof may become slippery in adverse conditions, wipe dry before attempting to walk on roof section. Extreme care should be taken to avoid falling from the vehicle.**

**WARNING: When walking on the roof, deck type shoes should be worn – not leather sole**

### TYRES

**If a wheel or tyre fitted to a wheel is changed any replacement must be of the same type of construction and size.**

The law requires that the tyres and pressures must be suitable for the use to which they are being put. The minimum tread depth must be 1.6mm throughout a continuous band comprising the centre three-quarters of the breadth of the tread and around the circumference of the tyre.

Please refer to base vehicle manufacturer's handbook for tyre pressure information. This may also be displayed in the driver's door aperture.

### DEDICATED TRAVELLING PASSENGER SEATING

Seat belts are fitted to all travelling seats. Travelling seats are designated by the manufacturer and vary according to the layout you have purchased. Each seat is homologated i.e. tested to all relevant safety requirements. **NEVER** travel in or attempt to install a seatbelt to a non-designated seat.

**WARNING: Side facing seats are designed for habitational use only, not for use when the vehicle is in motion.**

#### Seat belts and legislation

Designated driver and passenger seats are fitted with seat belts and **MUST** be worn.

Children, aged up to 3 years of age, must wear an appropriate child restraint suitable for their age and weight. Children from 3 years of age and up to 135cm (4'5") in height, or 12 years of age, whichever is reached first must use a restraint suitable for their age.

Children over 135cm (4'5") in height or aged 12 or 13 years must wear a seat belt.

Note: It is the legal responsibility of the driver To ensure children aged up to 14 years old are suitably restrained. For passengers aged 14 and over, it is their responsibility (not the driver) that a seat belt is worn.



Fig 1

Designated passenger seats within the habitational compartment of your motorhome are identified (fig. 1). Seat belts are fitted for your safety and must be worn unless a

'Certificate of Exemption from Compulsory Seat Belt Wearing' is held. This Certificate must be produced if asked for by the Police – seat belt offences can result in a fine.

### CHILD SEATS

#### Choosing/Buying

Go to a reputable retailer such as Halford's, Mothercare, Toys R Us, John Lewis etc. Most reputable retailers will have trained child seat advisers on site and will offer a fitting service. Ask the advisor to fit various seats to the vehicle. Once a correctly fitting seat has been installed, satisfy yourself on its suitability for your child and the vehicle before buying as it is important to use a correctly fitting seat in your motorhome.

**CAUTION: The child seat you use in your car may not be suitable for mounting on a motorhome seat.**

Choose the right seat for your child's height and weight.

Ensure it has an official approval mark (usually the United Nations 'E' mark). The current UN standards is Regulation 44.03

Never fit or use a second hand car seat. It could have been damaged and may not meet modern standards. The fitting instructions may also be missing.

#### Positioning/ Fitting

Dependant upon the child seat type, the most suitable position for the child seat to be fitted may be the front passenger seat of the cab (NOTE airbag advice below) or the window seat of the forward facing rear seat, the isle seat in the rear is not a recommended position, advice should always be taken from the retailer on the suitability and security of the seat in the motorhome.

Read and follow the child seat manufacturer's instructions for fitting the seat.

All Swift Motor homes are fitted with inertia reel seat belts, however, the child seat must be tight in the adult seat. Push all your weight into the child seat as you tighten the belt.

Keep a copy of the child seat fitting instruction in the motorhome for easy reference.

Any doubts, ask an advisor to show you how to correctly install the seat.

#### Airbag

Never fit a rear-facing child restraint in a seat with an active airbag in front of it.

Forward-facing child restraints should be positioned as far back from the airbag as possible. Check the base vehicle handbook.

### THREE POINT SEAT BELTS

This section refers to the seat belts located in the habitation area of your motorhome.

#### Fastening the seat belt:

Insert tongue into buckle; a positive 'click' indicates correct assembly.

#### Releasing the seat belt:

Press the red release button, the tongue will be ejected from the buckle.

- The belt is designed for use by one person and must not be put around a child seated on a person's lap.
- The belt is suitable for restraining most child seats and boosters.
- The belt should at all times be adjusted and used in accordance with the instructions. No excessive slackness should be present.
- Once installed the diagonal should pass across the centre of the shoulder and the buckle should lie just on or below the hip.
- Avoid twisting the webbing during use.

## Preparing for the road

Webbing must not be allowed to chafe against sharp edges.

- Do not make alterations or additions to the belt.
- Belts that have been cut, frayed, damaged or stressed through impact should be replaced. After impact the motorhome anchorage points should also be checked.
- To clean use warm soapy water only.
- Periodic inspection of the installation will ensure reliability of the seat belt.

### DRIVING LICENCE

Licences issued to drivers who passed their car driving test before 1st January 1997 include categories B+E and C1+E which gives them entitlement to drive motor vehicles up to 7500kg MTPLM.

Drivers who passed their test on or after this date have category B entitlement only, which restricts the entitlement to motor vehicles with up to 8 passenger seats and an MTPLM of up to 3500kg with trailers up to 750kg MTPLM (4250kg combined) or larger trailers providing the combination of the trailer and towing vehicle does not exceed 3500kg and the MTPLM of the trailer does not exceed the unladen weight of the towing vehicle.

Drivers who passed their test on or after the 1st

January 1997 will need to take an additional test(s) to gain the B+E and C1+E entitlement.

A number of Swift Group motorhomes have an MTPLM greater than 3500kg, therefore you must check you have the driving licence entitlement for the vehicle you drive.

### VEHICLE CLASSIFICATIONS

Motorhomes up to 3500kg MTPLM are P/LGV (Private Light Goods Vehicles), motorhomes with an MTPLM over 3500kg and up to 7500kg are P/HGV (Private Heavy Goods Vehicles). These are used in defining MOT classifications and vehicle excise duty (road tax) classifications.

### ADVICE ON TOWING

The towing capability of each motorhome differs depending on the specific chassis and engine types, (see 'Towing Capabilities' in your specification handbook).

This takes account of the maximum front and rear axle loadings as well as the minimum front axle loading in two conditions, MRO and MTPLM condition.

Towing in these, and any other condition requires sensible loading and distribution of payloads to ensure the requirements of the towing capability table are met.

When towing, the demands on both the vehicle and driver increase. A trailer reduces manoeuvrability, the ability to climb hills, acceleration and braking capacity and makes the vehicle handle and corner differently. It will also increase the fuel consumption of the vehicle.

Always brake in good time. Special care must be taken when descending gradients. Change down before going down a steep hill so the engine can act as a brake. Ensure that the towing vehicle tyre pressures are correct and adjusted for full load conditions and that the trailer tyre pressures are as recommended by the trailer manufacturer. Regularly check the operation of trailer brakes and lights.

For maximum stability, when loading the trailer ensure that the loads are properly secured during transit. Position loads so that most of the weight is placed close to the floor and, where possible, immediately above or close to the axle(s). Where the load can be divided between trailer and tow vehicle, loading more weight into the vehicle will generally improve the stability of the combination. After loading the trailer, check that the nose weight and axle loads are in accordance with the manufacturer's recommendations, also check the rear and front axle loads on the motorhome. When calculating the laden weight of the trailer, remember to include the weight of the trailer PLUS THE LOAD.

**NOTE: Towing regulations vary from country to country. It is very important to ensure that national regulations governing towing weights and speed limits are observed (refer to the relevant national motoring organisation for information). The stated maximum permissible towing weights refer to the vehicle's design limitations and NOT to any specific territorial restrictions.**

Notes:

- i) Do not exceed the motorhome gross vehicle train weight.
- ii) Do not exceed the maximum front & rear axle loads on the motorhome.
- iii) Ensure the motorhome front axle load is never less than 40% or more than 70% of the total weight.
- iv) Motorhomes with an MTPLM up to 3500kg which have European Type approval can only be fitted with a type approved towbar complying to 94/20/EC.
- v) The limit for towing an un-braked trailer is 750kg (based on VIN plate not actual weight), this applies to a towed car.
- vi) A car dolly with a car with a GVW over 750kg in place is considered as two trailers, these are legal for use for recovery but under the Road Traffic Regulations Act

1984 the combination is limited to 40 mph on motorways and dual carriageways and 20 mph elsewhere. A car dolly is not legal for transportation (there is a very specific difference between recovery and transportation. Recovery is defined as the removal of a broken down vehicle to a place of safety).

- vii) The maximum permitted vehicle combination length is 18.75m, however any combination must ensure compliance with the turning circle requirements of Construction and Use regulations 1986 & 97/27/EC.

## Preparing for the road



**'EN ROUTE'**

<b>Cruise Control</b> .....	<b>22</b>
<b>Removal of spare wheel on ALKO conversion:</b> .....	<b>22</b>
<b>ALKO conversion alternative spare wheel removal:</b> .....	<b>23</b>
<b>Removal of FIAT/PEUGEOT spare wheel:</b> .....	<b>24</b>

## CRUISE CONTROL

The driver of the vehicle should always remain seated and in control of the vehicle when cruise control has been engaged. Never leave the driving seat for any reason when the vehicle is underway.

## REMOVAL OF SPARE WHEEL ON ALKO CONVERSION:

Caution: Exercise care when lowering the wheel and frame due to its weight.

### Removal

- a) Spare wheel in the stowed position (Fig. 1).
- b) Remove the securing pins (a) from the supports (b) at each side of the spare wheel carrier frame (c) (Fig. 2).
- c) Lift the wheel carrier frame (c) slightly and move the frame supports (b) forward and clear of the carrier frame (Fig. 3).
- d) Lower the carrier frame and wheel to the ground (Fig. 4).
- e) Remove the spare wheel.

### Replacement

Replacement is a reversal of the removal procedure. Ensure the securing pins (a) are correctly located in the frame supports (b).

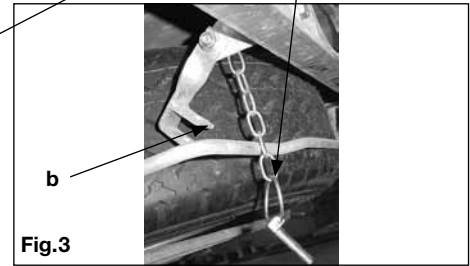
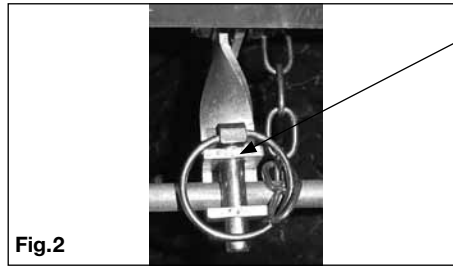

## ALKO CONVERSION ALTERNATIVE SPARE WHEEL REMOVAL



Loosen the bolts (17mm socket M10) inside the hook assemblies positioned at each side. Carefully lift and release the carrier from the hooks to remove the spare wheel.

## 'En route'

### REMOVAL OF FIAT/PEUGEOT SPARE WHEEL:

- the ground should be flat and adequately firm.
- turn the engine off and engage the handbrake.
- engage first gear or reverse.

#### Removal

- wheel restraining device screw (fig 1) – rear right side of vehicle
- use the extension and wrench provided to operate the wheel restraining device screw (fig 2).
- when the wheel is fully lowered (fig 3) and the restraining device screw can turn no more, use the wrench to pull the wheel out (fig 4).
- loosen the knob and remove the support to release the wheel (fig 5 & 6).

#### Replacement

Replacement is a reversal of the removal procedure.

Caution: Exercise care when handling the wheel due to its weight.



# SAFETY & SECURITY

<b>Fire</b> .....	<b>26</b>
<b>Ventilation</b> .....	<b>29</b>
<b>Escape paths</b> .....	<b>29</b>
<b>Children</b> .....	<b>29</b>
<b>Security</b> .....	<b>29</b>

# Safety & security

## FIRE

**Important:** Your attention is drawn to the notice affixed inside the caravan advising on fire precaution, ventilation and what to do in case of fire.

### IN CASE OF FIRE

#### Fire

Important: Your attention is drawn to the notice affixed inside the caravan advising on fire precaution, ventilation and what to do in case of fire.

### IN CASE OF FIRE

1. Get everyone out of the caravan as quickly as possible using whichever exit is the quickest, including windows. Do not stop to collect any personal items.
2. Raise the Alarm. Call the Fire Brigade.
3. Turn off the gas supply valve if it is safe to do so.
4. Turn off the electricity supply at supply point.

## MODEL- SI 601 SMOKE ALARM OPERATION

### Normal condition

The red LED on the front should flash once every 40 seconds to show the alarm is active.

### Low Battery Condition

**IMPORTANT:** Your smoke alarm requires a battery with a sufficient capacity of power to operate correctly. This must also be correctly installed.

Should your smoke alarm enter a low battery condition, the unit will emit an audible 'chirp' once every 40 seconds. When this occurs you must replace the battery immediately. Your smoke alarm will continue to warn of this low battery condition for at least 7 days, however, failure to change the battery after this time would mean your smoke alarm has insufficient power to alert you in a real fire situation.

### BATTERY REPLACEMENT

**IMPORTANT:** Only the following batteries can be used for replacement. Use of a battery other than those recommended below may have a detrimental effect on the detector's operation. Use of a lithium (long-life) battery could provide power for 10 years under normal operating conditions, meaning there is no need for an annual battery change.

**NOTE:** The alarm cover can't be installed without a battery fitted.

**NOTE:** Upon delivery the battery may be fitted with a protective cover. Please ensure this is removed before use.

### Carbon-Zinc type:

Eveready Energizer 1222;

Gold Peak 16045 (UL).

### Alkaline Type:

Energizer 522; Duracell MN 1604; Duracell 9V

Ultra; Energizer 9V Ultra+; Gold Peak 1604A.

### Lithium (long life) type:

Ultralife U9VL

1. Remove the alarm from its mounting plate by turning anti-clockwise



## Safety & security

2. Remove the existing battery and replace with a new battery. From the list on this page, making sure that the positive and negative connections are in the correct position. If unsure see the alarm user manual.



3. Replace the alarm on its mounting plate, lining up the large central vent on the front of the alarm, with the 'X' that is moulded into the plastic on the mounting plate (if unsure see page 13 of the alarm user manual). Ensure the unit is securely fitted.



4. Test your alarm as explained in the next section 'Alarm Test'.

### ALARM TEST

1. Press the test button in the centre and release.

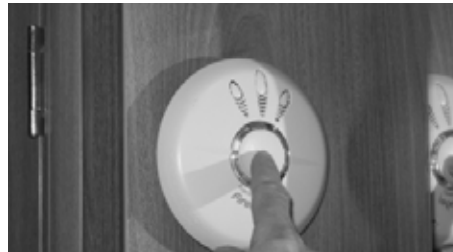

2. The unit will emit a loud (85dB at 3 meters) alarm for around 5 seconds and stop automatically.



3. The red LED on your alarm will flash rapidly during the audible signal.



**NOTE:** The test button accurately tests the alarm's smoke sensing circuit, there is no need to test your alarm with smoke. If your smoke alarm fails to give an audible test signal, please refer immediately to the troubleshooting guide at the end of the user manual.

## Safety & security

**WARNING:** Test your smoke alarm at least once per week

Your smoke alarm has been designed to be as maintenance - free as possible and although the unit requires only battery maintenance for its entire life, there are several things you must do to keep it working properly.

**CAUTION:** Your smoke alarm is a sealed electrical device and no attempt should be made to open the case. Attempting to open the case will invalidate your Warranty.

**TESTING:** Test your smoke alarm once every week see section 'Alarm Test' in the smoke alarm instruction manual. Any test failures should be reported to the Technical

Support Team details in alarm instruction manual.

**CLEANING:** As a minimum your smoke alarm should be cleaned once every 3 months using your vacuum cleaner fitted with the soft brush attachment.



**WARNING:** Your smoke alarm may false alarm when it is being cleaned using a vacuum cleaner.

**IMPORTANT:** Do not use solvents or cleaners on your smoke alarm, as they may cause damage to the sensor or circuitry. The unit can be wiped with a slightly damp cloth.

**Warning:** The electronic test button provides a full test of the unit's functionality. DO NOT try to test the alarm with a naked flame, as this may present a potential fire hazard.

**WARNING:** Never use portable cooking or heating equipment other than electric heaters that are not of the direct radiant type, as it is a fire and asphyxiation hazard.

**WARNING:** Appliances such as cookers must not be used for heating.

### Fire Extinguisher

It is recommended that a dry powder fire extinguisher be carried inside your caravan at all times.

When using a dry powder extinguisher it is suggested that the caravan be evacuated until the powder has settled, to avoid inhalation.

A fat pan fire should not have a fire extinguisher aimed at it. It should be smothered with a fire blanket.

**WARNING:** Provide one dry powder fire extinguisher of an approved type or complying with ISO 7165, of at least 1kg capacity, by the main exterior door and a fire blanket next to the cooker.

Familiarise yourself with the instructions on your fire extinguisher and the local fire precaution arrangements.



### VENTILATION

All motorhomes comply with BS EN 721. The ventilation points on your motorhome are fixed points of ventilation which are required by the European Standards.

All motorhomes have ventilation at high level and low level which have been calculated to suit the individual needs of your motorhome.

High level ventilation is achieved by means of the roof lights and washroom roof ventilators. The low level ventilators are positioned underneath the oven housing. Some models in the doorway stepwell.

Under no circumstances must these vents be blocked or obstructed, even partially.

It is advised that fixed ventilation points are checked and cleaned (if necessary) on a regular basis using a small brush and a domestic vacuum cleaner.

Additional night time ventilation is obtained by releasing the window catches and placing them in the second groove. Note the windows are not sealed from rain in this position.

As the ventilation levels are calculated to suit each model's requirements there should be no modifications made which may result in reduced ventilation levels.

**WARNING: Do not obstruct ventilation.**

**WARNING: Never use portable cooking or heating equipment other than electric heaters that are not of the direct radiant type, as it is a fire and asphyxiation hazard.**

**WARNING: Appliances such as cookers must not be used for heating.**

### ESCAPE PATHS

It is important that you do not block escape paths to emergency exits with obstructions or hazards.

### CHILDREN

Do not leave children alone in the motorhome in any event. Keep potentially dangerous items out of reach, as at home eg matches, drugs etc.

### SECURITY

#### Motorhome Theft

The theft of a motorhome can occur in the most unlikely circumstances; from a motor-way service area or even an owner's driveway.

Secure all windows and doors when your motorhome is unoccupied even if only for a short length of time.

### VIN (Vehicle identification Number)

Record your motorhome VIN which can be found on the lower edge of the base vehicle front windscreen and the plate located on the front cross member under the bonnet.

Make a note of these numbers in the space provided at the front of this handbook and make a separate note of the numbers to keep safe at home.

#### Additional security

Consider fitting any device which might deter intrusion by thieves. Customers are advised to identify their motorhome with a method for subsequent identification if other forms of identification have been altered or removed.

Free crime prevention advice about securing your motorhome, protecting your valuables, property marking either at home or whilst on site, can be obtained from the Crime Prevention Officer through your local Police station.



# ARRIVAL AT SITE

**Positioning the motorhome..... 32**

## Arrival at site

### POSITIONING THE MOTORHOME

**Note: Check and observe site regulations.**

Keep to roadways unless otherwise directed. Adhere to speed limits. Note that these are generally 10mph.

**(Remember that the stopping distance on grass is considerably greater than on tarmac.)**

Only a person in possession of a current driving licence may drive on the site.

#### Selecting a pitch

Do not pitch in such a position that your motorhome will obstruct others coming in.

Try to choose an area which is dry, reasonably level and preferably with a hard base.

If you have no alternative but to pitch on a slope try to ensure that you are facing down the slope, for when you leave.

#### Levelling the motorhome

Levelling must be carried out in both directions for the refrigerator and other equipment to function correctly. Stepped levelling boards (Fig. B) or proprietary ramps are ideal for this purpose. Levelling pads or boards should be used under the steadies where the ground is soft or uneven.



**Fig. A Winding the corner steady**

Lower the rear corner steadies (if fitted) until they are in firm contact with the ground (Fig. A). DO NOT use the steadies as a jack, they are only a means of stabilising the rear of the motorhome. Levelling pads or boards should be used under the steadies where the ground is soft or uneven.



**Fig. B Stepped levelling board**

#### Awnings and Tents

Awnings and tents should only be used when permission has been obtained. When on grass and staying for more than a few days the ground sheet and/or side flaps of awnings should be periodically raised in order to avoid damage to the ground.

# CONNECTING SERVICES

<b>Water system</b> .....	<b>34</b>
<b>Typical Gas schematic drawing with water heater</b> .....	<b>37</b>
<b>Typical Gas schematic drawing with combi boiler</b> .....	<b>38</b>
<b>Gas</b> .....	<b>39</b>
<b>Types of gas</b> .....	<b>40</b>
<b>Gas safety advice</b> .....	<b>40</b>
<b>Ventilation</b> .....	<b>41</b>
<b>En-route heating</b> .....	<b>43</b>
<b>Electricity</b> .....	<b>45</b>
<b>Overseas connection</b> .....	<b>46</b>
<b>230V mains electrical equipment power consumption</b> .....	<b>48</b>
<b>Typical appliance consumption figures</b> .....	<b>49</b>

## Connecting services

Connection of services are dealt with under separate headings. In all cases become familiar with manufacturers' instructions.

**Before making connections of any description to the motorhome ensure ALL equipment is turned off.**

### Fresh water system

- (i) All fittings, including the holding tank, water pipes, taps and connections are of food quality material (to BS6920) and therefore, should not affect the quality of the water used. It is recommended however, that the system is flushed through twice before it is used for the first time, and always cleaned/flushed after it has stood unused for a period of time (eg over the winter period). Care has been taken (using smooth bore pipes etc) to eliminate as many water traps as possible.
- (ii) When filling the fresh water system remember to check that the water source is suitable for use as drinking water and, if you are using a hose pipe or water carrier, that it is also made from nontoxic materials (preferably food quality material).
- (iii) The fresh water tank may be drained either via a plug in the base of the tank accessible via the cleaning hatch or by the drain tap situated below the skirt panel (model specific).

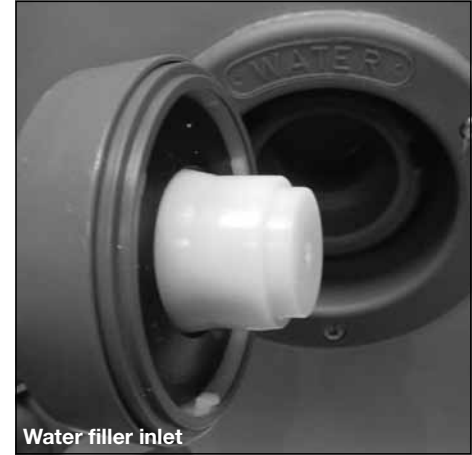

Water filler inlet

- (iv) The fresh water system is pressurised by a pump which will continue to operate until it senses a pre-set pressure in the system.

**WARNING: If the fresh water tank is completely empty the pump will be unable to pressurise the system and will operate continuously. In this situation it is essential that, in order to avoid damage to the pump, it is switched off using the pump isolator switch on the distribution panel until such time as the water tank has been filled.**

### Waste water system

- (i) The waste water holding tank is secured underneath the chassis of your motorhome and is gravity fed.
- (ii) In order to eliminate unpleasant odours as much as possible, only smooth bore pipes are used. These are fitted with waste traps under the floor which should be cleaned periodically by unscrewing the lid and flushing with clean water.

## Connecting services

When filling, use a hose manufactured from non toxic material, to prevent tainting of the water. Remember, if the water heater has been drained it will require 2.2 gal/ 10 litre or 2.6 gal/ 12 litre (dependant upon model) of water to fill it.

To do this open all hot water taps (except shower) and run pump until water comes from the taps.

Top up fresh water tank after priming the water system. As with the waste tank, a valve is fitted in the skirt area allowing drainage of the fresh water tank.

Please ensure all taps are fully turned off when not in use.

We recommend the use of Milton 2 sterilising fluid for cleaning and sterilising the water tank and system.

An explanatory leaflet is available from:  
The Milton Food Hygiene Advisory Service,  
Whitehall Lane, Egham, Surrey, TW20 9NW

### Fresh and waste water tank heaters

12v heating elements or the provisions for them have been added to your motorhome. For details of the control and operation of these see control panel instructions on page 53 or 57 (model specific).

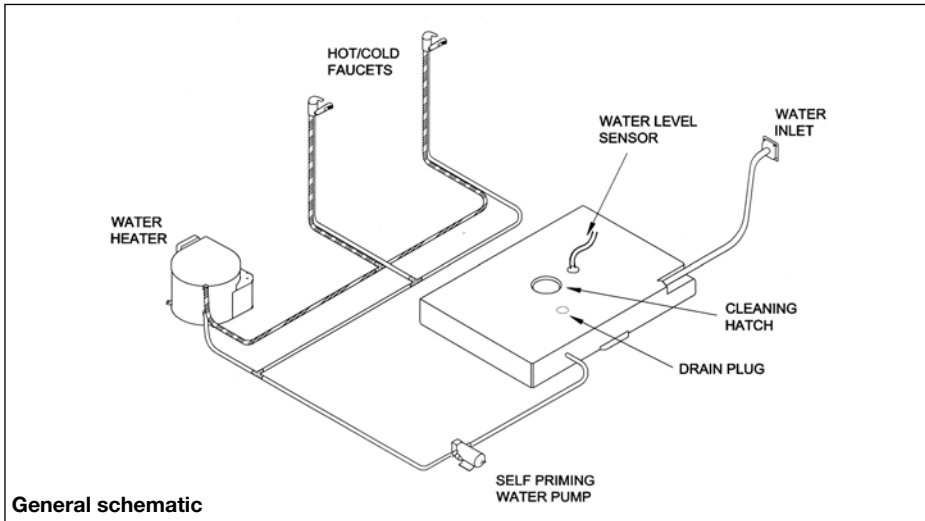

General schematic

However, should the waste water tank be overfilled, then the waste water will backfill the drain pipes until it eventually appears in the shower base. In order to prevent this, please take note of part (iii).

- (iii) The waste water gauge shows the level of the tank in quarter increments, it is therefore, recommended that the waste water tank is checked on a daily basis, emptying when required. This is done by opening the valve located just beneath the

side skirt on the exterior of the Motorhome or by turning the handle located inside the vehicle at floor level behind the rear axle, usually found in bed box or wardrobe base (model dependant).

It should be emptied either directly, or via a waste water container (not supplied) into a designated waste water area.

### Fresh Water Tank

Your motorhome is fitted with a water tank filled from the outside via a lockable water filler cap.

## Connecting services

### Guidance on cleaning portable water tanks and the water system in motor caravans

The water systems, and in particular storage tanks, in Caravans or Motorhomes are susceptible to contamination by bacteria if care is not taken with their use and cleaning.

The symptoms caused by bacterial contamination are not purely limited to gastrointestinal diseases, but may also manifest themselves as ear, nose, throat, eye or skin infections. It is therefore important that you carry out the following procedure prior to using the Caravan or Motorhome each time, even if you boil or filter all water you use for drinking.

#### Separate Water Containers

1. All water remaining in the container should be disposed of so that the container is empty.
2. The outside of the container should be thoroughly cleansed and washed down to remove any dirt, dust or other contaminant. Water at a suitably hot temperature containing an appropriate detergent is recommended for this purpose.
3. Water should be put in the container, swirled around, then emptied out.
4. The container should then be totally filled with water containing an appropriate sterilant solution and allowed to stand for the recommended contact time (e.g. Milton for 15 minutes).

5. The solution should be emptied from the container.
6. The opening of the container should be cleaned thoroughly with an appropriate prepared wipe impregnated with a sterilant.
7. The container should be inverted whilst stored overnight (if possible).
8. The container must be filled with mains water only and mains water only should be used for the above cleaning procedure.
9. On no account should garden hoses be used to fill water tanks.

#### For Systems:

1. Drain down the system (open all taps to allow air in, enabling the system to drain quickly).
2. Remove any water filters fitted, and replace with a short length of hose or empty filter cartridge (this will ensure the filter is not affected by the disinfectant/sterilant solution).
3. Fill the system by using the pump with a disinfectant/sterilant solution (check that the solution at full strength appears at all taps/showers). Allow to stand for the recommended period of time.
4. Drain the system completely.
5. Thoroughly clean the outside of all taps/

connectors with a cloth soaked in the disinfectant/sterilant.

6. Flush the system through with clean drinking water until no traces of disinfectant/sterilant can be detected at any tap.
7. Replace the filter. Suitable sterilising chemicals are available from your Caravan or Motorhome dealer, accessory shop, chemist or home-brew shops. It is not, however, recommended to use bleach or sodium metabisulphite.

This guidance has been prepared with the kind co-operation and assistance of The Environmental Health Department of The Borough Council of King's Lynn and West Norfolk.

#### Warranty

Products are guaranteed from the date of purchase against defects in materials and workmanship. If the unit proves faulty, return it to your supplier with proof of purchase and purchase date. Please note that frost damage is not a valid warranty claim. The manufacturer retains the right to repair or replace the unit. The manufacturer cannot be held responsible for claims arising from incorrect installation, unauthorised modification or misuse of the product. The above does not affect your statutory rights.



## TYPICAL GAS SCHEMATIC DRAWING WITH WATER HEATER

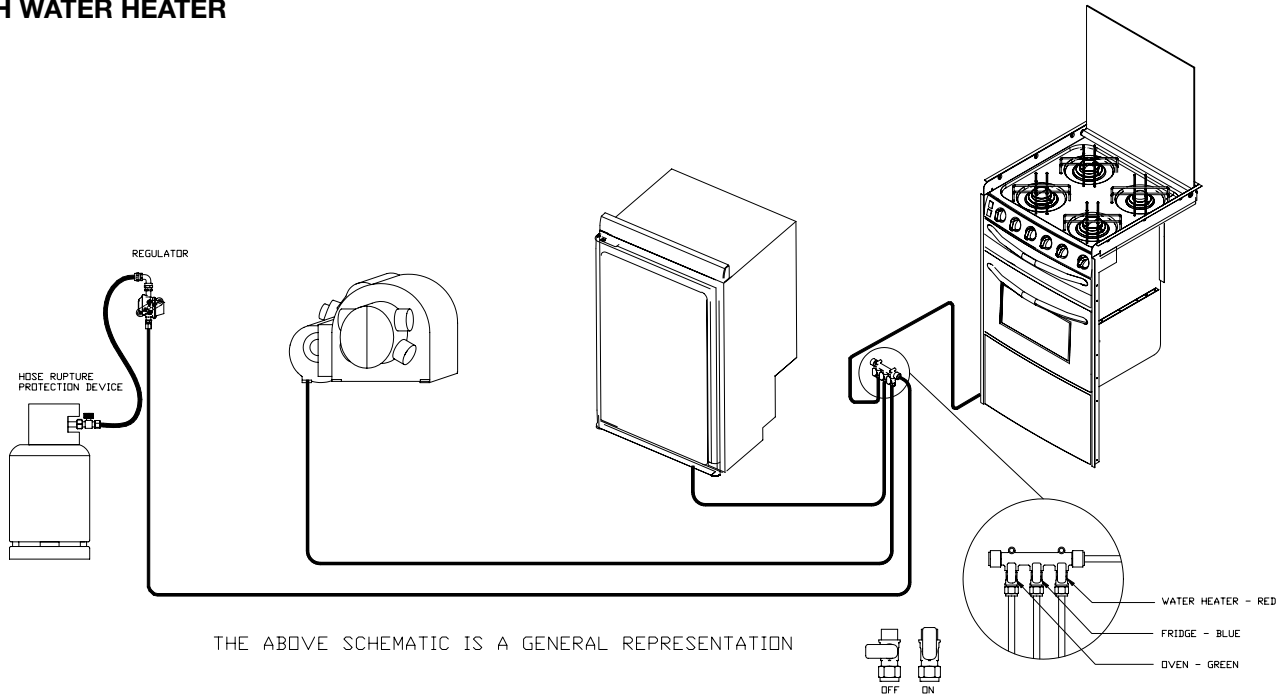

THE ABOVE SCHEMATIC IS A GENERAL REPRESENTATION

# Connecting services

## TYPICAL GAS SCHEMATIC DRAWING WITH COMBI BOILER

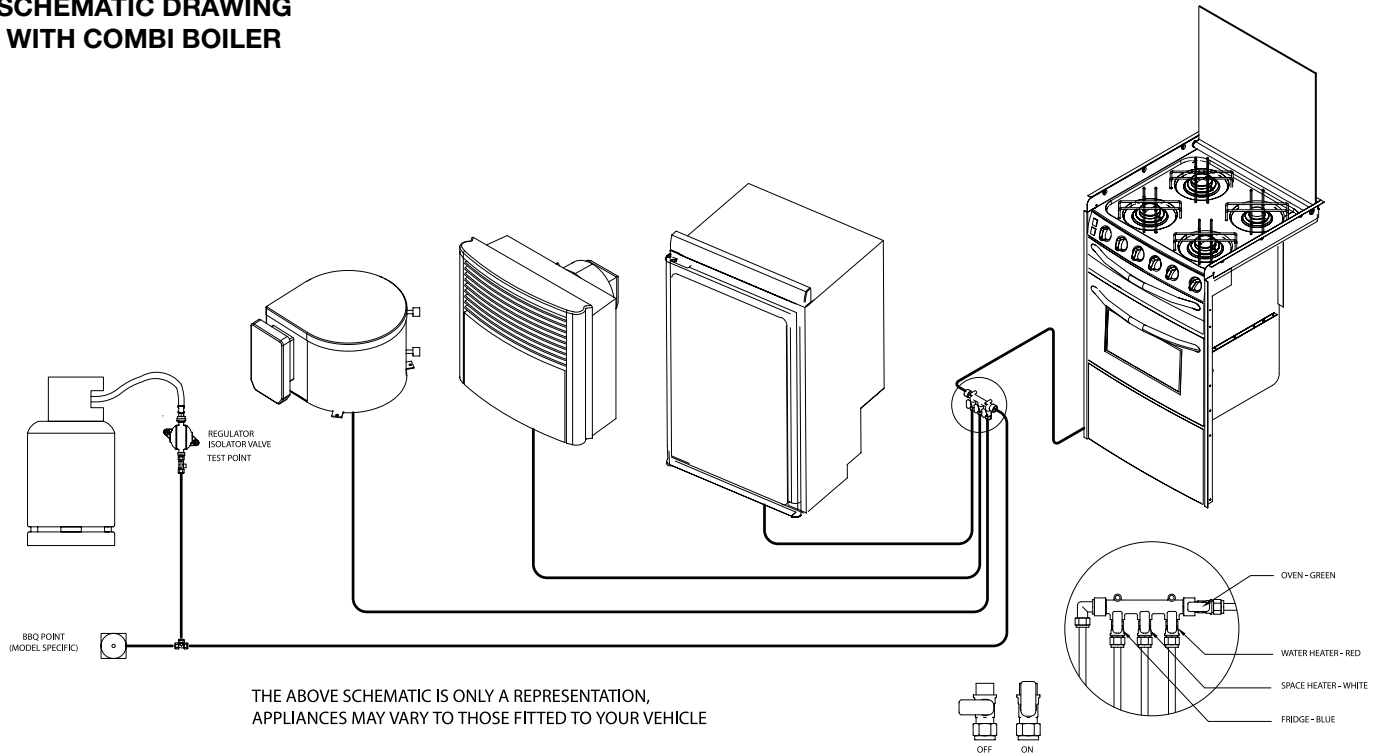

## Connecting services

### GAS

#### GENERAL INFORMATION

##### Gas Bottles

Bottled Liquefied Petroleum Gas (LPG) is the most convenient portable source of fuel for your vehicle.

Unless en-route heating has been installed, make sure that heating and cooking appliances and the gas cylinders are switched off before you move the vehicle.

Your Motorhome has a factory fitted habitation en-route LPG heating system that can be used whilst travelling. Fig 1 shows the two safety valves features that are part of the system, these are there for your safety whilst using the system when travelling. When in use ensure all other gas appliances are separately isolated

**Warning: isolate cylinders when re-fuelling**

Regularly check flexible gas hose, joints and connections for tightness. Finally make sure that each gas appliance is working efficiently to the recommendations of the appliance manufacturers.

Only use gas bottle cylinders that are located within their dedicated position within the gas bottle housing, never extend hose - hose lengths must not exceed 400mm.

##### Regulator for systems approved for use when travelling (Fig 1)

Your vehicle is supplied with a wall mounted gas regulator plumbed inside the gas bottle compartment. The regulator and all appliances work at a harmonised 30mbar pressure, which work with Butane and Propane gas.

Pressure regulation system in this vehicle has a fixed working pressure of 30 mbar with a flow rate of 1.2 kg/H and complies with the requirements of EN 12864 annex D.

We do not recommend the use of an inline LPG BBQ with the 1.2kg/H regulator when other LPG appliances are in use.

**Note: Unless en-route heating is in use the regulator valves should be in the 'OFF' position when driving.**

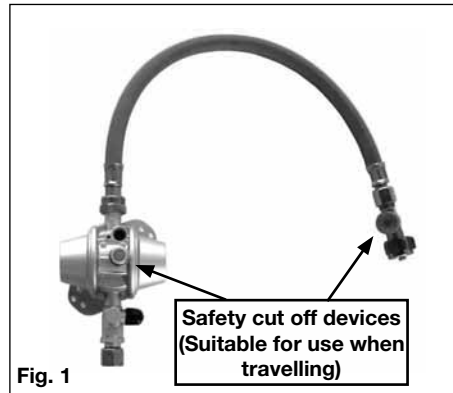

Fig. 1

##### REGULATOR for systems NOT approved for use when travelling. (Fig 2)

**Note: The regulator valves should be in the 'OFF' position when driving.**



Fig. 2

**Note: No safety device on this system**

##### Gas Hoses

High-pressure hoses or pigtails as they are called must be used with the new style regulator.

High-pressure hoses incorporate a safety shut off valve for the use of the en-route heating system

LPG bottle i.e. Propane, Butane, BP and Camping Gaz cylinders all have unique bottle adaptor connections. It is important to check you have the correct hose and adaptor to suit your gas bottles.

## Connecting services

Push on hoses are no longer permitted under the latest regulations.

The new high-pressure hoses have threaded connections and must be securely attached to the regulator and to the gas bottle.

Ensure that there is a constant rise in the flexible gas hose between the gas bottle outlet and the regulator elbow.

**WARNING: Inspect flexible gas hose(s) regularly for deterioration and renew as necessary with the approved type, in any case no later than 5 years after the date of manufacture marked on the hose.**

**When replacing the hose ensure the new hose incorporates a safety shut off valve**

**WARNING: Ensure hoses do not become entangled in door mechanism.**

## TYPES OF GAS

### Butane

Butane is supplied in the UK in green, blue or aluminium bottles.

All these have a male left hand thread EXCEPT for Camping Gaz which has a special female right hand thread and Calor 7kg and 15kg and aluminium bottles which have a special clip-on connection.

Continental bottles usually have a male left hand thread similar to but not identical with UK butane.

Butane is suitable for use at temperatures down to 2°C but will not work below that.

### Propane

Propane is supplied in red, or partly red bottles which have a female left hand threaded connector.

Scandinavian countries use the same connector.

Germany and Austria supply propane with a male connection.

Propane will work at temperatures as low as -40°C and is therefore suitable for all winter caravanning.

## GAS SAFETY ADVICE

**Warning: if you smell gas or suspect a leak and if it is safe to do so, isolate the gas appliances and turn off the gas bottles at the regulator. Evacuate the vehicle and ventilate. Seek professional advice as to the cause of the leak.**

### Facts about LPG

LPG is not poisonous. Bi-products are harmless.

There is danger if all air and oxygen were excluded. (Ventilation holes must be kept clear at all times).

LPG has been given a smell by the manufacturers in order to identify leaks.

### Awning Spaces LPG Appliance Exhaust

There is no danger of pollution of an enclosed awning space by the LPG exhaust from a refrigerator venting into it, as awning spaces are generally well ventilated.

Space heaters may produce sufficient exhaust to pollute the awning space, if it is totally enclosed, from a general comfort, smell and hygiene point of view. In the extreme case there could be a build up of carbon dioxide to a dangerous level.

## Connecting services

Owners are advised to allow some fresh air circulation in the awning space when such appliances are in use.

### PRECAUTIONS

- a) Never look for a leak with a match. Always use a soap solution or its equivalent when testing connections. Do not operate any electrical apparatus whatsoever, especially light switches. If the leak is not obvious, the vehicle should be evacuated and qualified personnel consulted.
- b) Always turn off the gas cylinder valve or inlet to the vehicle when the appliances are not in use.
- c) Never use gas appliances without adequate ventilation.
- d) Avoid naked lights when connecting or changing a cylinder.
- e) Check the flexible hose frequently.
- f) The gas is heavier than air and therefore sinks to the lowest point.
- g) Keep bottle gas containers outside (and protected against frost). If they must be kept inside make sure they are well away from heat.
- h) Always seek advice when in doubt.

**Warning: Do not use appliances with a different working pressure to 30mbar.**

**Warning: Maintain adequate spacing of combustible materials from sources of heat.**

**Warning: Do not use independent portable gas appliances inside the vehicle.**

**Always read individual appliance instructions**

### VENTILATION

All ventilation complies with BSEN 721 and vents should not be obstructed in any manner as this could lead to insufficient fresh air. In this case the confined atmosphere becomes depleted of oxygen which leads to the formation of the highly poisonous gas 'carbon monoxide'. Carbon monoxide is odourless, colourless and tasteless and will rapidly cause unconsciousness and death with little or no warning prior to collapse. THERE IS NO DANGER WHEN ADEQUATE VENTILATION IS PROVIDED.

#### Roof-mounted flue installations

All flue installations should be inspected once a year throughout their length for corrosion. Flues should be replaced if any sign of perforation

is found. Ensure that the replacement is of an approved type.

#### Changing gas cylinders

The following procedure should be adopted:

- a) Extinguish any fire, flame or source of ignition (including cigarettes, pipes and pilot lights) before changing gas cylinders.
- b) Wherever possible change gas cylinders in the open air.
- c) Ensure that the gas cylinder valve(s) is/are closed before disconnecting any empty cylinder or before removing the plastic cap or plug on the outlet connection of the replacement cylinder. (Note. left hand thread.)
- d) Make firm gas-tight joints. Any leaking vapour will smell. If a leak is suspected after changing gas cylinders and opening valve, test by brushing with soapy water around the joints. Bubbles will form if vapour is leaking. Never use a naked flame.
- e) Ensure that the replacement gas cylinder is the correct one for the installation.
- f) Gas cylinder valves are of various designs depending on the type of cylinder and the use for which it is intended and it is essential that the correct pressure regulator with the correct pressure setting and capacity for the installation is used in accordance with manufacturer's instructions.

## Connecting services

- g) In the case of a connection on the pressure regulator which relies upon a sealing washer(s) to maintain a gas-tight joint, it is essential to check that the washer is present, is sound and is correctly positioned prior to making the connection. Where the connection relies on a metal to metal seating or bull nose connection to obtain a gas-tight joint it is essential that the mating surfaces are clean and undamaged. In no case should a damaged valve or connection be used.
- h) Where connections are designed to be tightened with a spanner, it is essential that a spanner of the correct size is used and that the union is firmly tightened, hand tightness is not sufficient. When self-sealing valves are incorporated in a gas cylinder, connections should be made in accordance with the manufacturer's instructions and tools should not be used.

### Leaks

Action to be taken in the event of a suspected leak:

- a) If a gas leak is suspected, close the gas cylinder valve or other valve at the inlet to the vehicle. Do not operate electrical switches. Open all doors and windows to disperse any gas escape.
- b) The strong unpleasant smell of LPG will enable the general area of the leak to be

detected. Check that gas is not escaping from an unlit appliance. In the case of a leak, close cylinder valve(s) and call a competent installer to rectify the fault.

- c) If a leaking gas cylinder cannot be stopped, remove the cylinder to a safe place in the open air in an upright position away from drains and any source of ignition.

### Fire

Precautions and actions to be taken:

- a) A fire extinguisher of adequate size and preferably of the dry powder type should be available.
- b) The initial use of dry powder extinguishers is recommended only if it is likely that the leakage can be stopped by closing the cylinder valve or that the cylinder can be speedily removed.
- c) Cool with water all gas cylinders that cannot be removed.
- d) As soon as possible remove cylinders adjacent to the fire to a safe place in order to gain access to the seat of the fire.

### Connection

Ensure that the gas regulator hose is correctly connected to the gas cylinder in the gas bottle compartment and that the hose connection is tight.

Gas bottles must be fully located, seated at the

base of the bottles and restrained by the strap provided in the dedicated compartment position.

Straps are positioned to suit 6kg, 7 kg and 13kg bottles.

**WARNING: If using cylinders other than those recommended, the user must ensure these are adequately supported, ventilation openings must not be obstructed and the cylinders must not cause damage to other fixtures and fittings located in the compartment.**

Open ended gas hoses must always be protected from dirt and insects.

Before turning on the gas supply at the regulator, ensure that all gas operated equipment in the vehicle is turned off.

All gas equipment is supplied through a central Gas Manifold System which has individual isolation taps for each appliance (Fig A), as follows:

RED	-	Water Heater/ Combination Boiler
WHITE	-	Space Heater
BLUE	-	Fridge
GREEN	-	Oven

## Connecting services

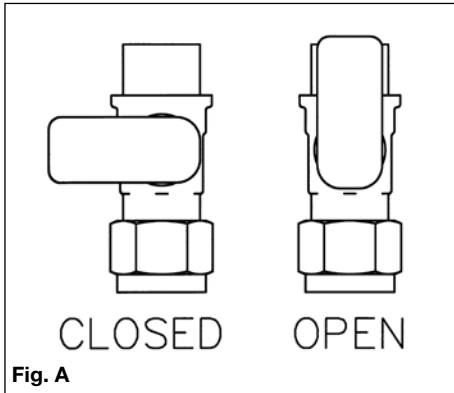

Fig. A

### EN-ROUTE HEATING

All Swift & Bessacarr Motorhomes are equipped with an LPG en-route heating system. The en-route heating system is installed with additional safety features.

**Warning when re-fuelling your motorhome, switch off the heater and close the cylinder valve.**

#### Safety features

- SecuMotion Drivesafe Regulator
- Gas flow monitor

- Hose rupture protection is installed.

The full system is Homologated in compliance with European Directive 2001/ 56/ EC,

#### Operating instructions

Taking into operation

- Close all LPG appliance shut off valves except the heater
- Open gas remote switch if present.
- Open the cylinder's valve. (1)
- Firmly press the green reset button on the high pressure hose. (2) Release button slowly
- Hold depressed the gas-flow monitor's green button on the gas-pressure regulator for about five seconds (repeat if necessary). (3) Release button slowly
- Start the gas-burning devices if desired. If the gas cylinders are closed, SecuMotion may switch off after an extended period of no usage.

#### Changing a gas cylinder

Please use the included screwing tool to attach and remove the high pressure hoses. It will help you generate the necessary tightening torque and will prevent damage to the screw fittings, which may otherwise result from using an improper tool.

**Residual gas: No smoking! No open flames!**

- Close the empty gas cylinder's valve
- Remove the high pressure hose from the gas cylinder and remove the slip-on adaptor, if present.
- Attach the high pressure hose to the full gas cylinder and apply the slip-on adaptor, if present.
- Open the full cylinder's valve.
- Press the hose-break safety device and the gas-flow monitor (see: Taking into operation).

Anytime after making changes, check the hose connection to the cylinder valve for leaks (see: Checking for leaks in the high pressure area).

#### Exchanging hoses

Please use the included screwing tool to attach and remove the high pressure hoses. It will help you generate the necessary tightening torque and will prevent damage to the screw fittings, which may otherwise result from using an improper tool.

Close the gas cylinder's valve.

- Remove the high pressure hose from the gas cylinder (or from the slip-on adaptor) and from the regulator inlet.
- Screw the desired high pressure hose onto the regulator inlet and onto the cylinder (or onto the slip-on adaptor).

## Connecting services

Open the gas cylinder's valve.

- Press the hose-break safety device and, if necessary, the gas-flow monitor (see: Taking into operation).

When changing hoses, make sure that the gasket inside the hose connection is installed properly and undamaged.

We recommend replacing the gasket every time you replace a hose. Anytime after making changes, check the hose connections to the cylinder valve and to the inlet of the SecuMotion gas-pressure regulator for leaks (see: Checking for leaks in the high pressure area).

### Checking for leaks in the high pressure area

A trained technician must check the low pressure area for leaks. In addition, we recommend that the person responsible for operating the gas system check the high pressure area for leaks after every cylinder or hose replacement.

In particular, the screw fittings on the gas cylinder valve and on the regulator inlet should be checked for leaks with the proper tools, such as a leak-finder spray according to DIN EN 14291.

**Warning: When travelling using the en-route system all other lpg appliance shut off valves must be in the closed position including the fridge, cooker, water heater etc.**

**Note: It is dangerous and illegal to operate other LPG appliances whilst travelling**

**Warning: If you smell gas or suspect a leak and it is safe to do so, isolate the heater and turn off the gas bottles at the regulator. Evacuate the vehicle and ventilate. Seek professional advice as to the cause of the leak**

**Service and repairs must only to be carried out by a competent service engineer.**

## THERMAL INSULATION AND HEATING

Your vehicle has been designed to achieve a thermal insulation and heating level for specific climatic conditions when tested according to the procedure in EN1646-1. The classifications are as follows:

### GRADE 1

A vehicle with an average thermal transmittance (u) that does not exceed  $1.7w/(m^2k)$ .

### GRADE 2

A vehicle with an average thermal transmittance (u) that does not exceed  $1.7w/(m^2k)$  and which can achieve an average temperature difference of at least 20k between inside and outside temperatures when the outside temperature is 0°C.

### GRADE 3

A vehicle with an average thermal transmittance (u) that does not exceed  $1.2w/(m^2k)$  and which can achieve an average temperature difference of at least 35k between inside and outside temperatures when the outside temperature is -15°C.



## Connecting services

### ELECTRICITY

As with electricity in the home, care must be exercised when handling mains electricity.

Your attention is drawn to the following notice as laid down by the Institute of Electrical Engineers.

#### INSTRUCTIONS FOR ELECTRICITY SUPPLY

##### On arrival at site

1. Before connecting the motorhome installation to the mains supply, check that:
  - (a) the mains supply is suitable for your installation and appliances, i.e. whether it is AC or DC and whether it is at the correct voltage and frequency, and
  - (b) your installation will be properly earthed. Never accept a supply from a socket outlet or plug having only two pins, or from a lighting outlet.
  - (c) any residual current device (earth leakage circuit breaker) in the mains supply to the vehicle has been tested within the last month.

In case of doubt, consult the site owner or his agent.

2. **Make sure that the switch at the site supply point is off.**

3. Lift the cover of the electricity inlet provided on the vehicle, and insert the connector of the supply flexible cable.
4. Remove any cover from the socket outlet provided at the site supply point, and connect the plug at the other end of the supply flexible cable to this. Switch on the main switch at the site supply point.

##### On leaving site

5. Switch off the main switch at the site supply point and remove the flexible cable connector replacing any cover fitted.
6. Disconnect the flexible cable from the vehicle.

**It is important that the main switch at the site supply point should be switched off, the supply flexible cable disconnected, and any cover replaced on the socket outlet at the site supply point before disconnecting the flexible cable from the vehicle. It is dangerous to leave the supply socket or supply flexible cable live.**

For vehicles that are generally left unused for long periods in the open it is strongly advised that the mains installation is inspected periodically to ensure that it is safe to use.

The IEE Wiring Regulations recommend that mains installations in motorhomes are re-

inspected every year. An annual inspection by a qualified person is recommended (see list below) who should sign and issue a periodic inspection report.

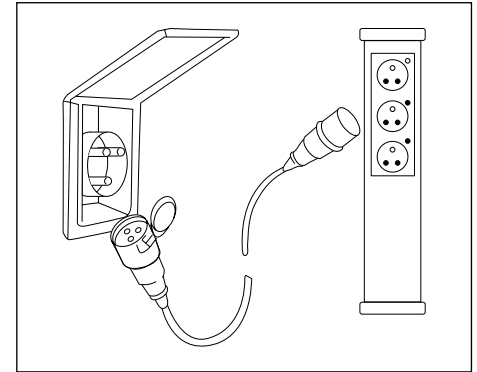

Suitably qualified persons acceptable to the SMMT/NCC to sign and issue Inspection and Completion Certificates should be one of the following:

- An approved contractor of the National Inspection Council for Electrical Installation Contracting\* or
- A member of the Electrical Contractors' Association of Scotland
- A qualified person acting on behalf of the above (in which event it should be stated for whom he is acting).

## Connecting services

- The names and addresses of Approved Contractors in any locality (there are over 10,500 in the UK) can be obtained from Electricity Shops, or direct from:

NICEIC  
Vintage House, 37 Albert Embankment  
London SE1 7UJ  
Telephone: 0207 564 2323

The names and addresses of members of the Electrical Contractors' Associations can be obtained direct from:

ECA  
Esca House, Palace Court  
London W2 4HY  
Telephone: 0207 313 4800

ECA of Scotland  
23 Heriot Row, Edinburgh EH3 6EW  
Telephone: 0131 225 7221

**In case of difficulty consult an approved electrical installation contractor (who may be the local electricity company). It is dangerous to attempt modifications and additions yourself. Lampholder-plugs (bayonet cap adaptors) should not be used in any circumstances.**

## OVERSEAS CONNECTION

Note: Connection to a mains voltage supply OVERSEAS requires particular attention.

Care must be taken when connecting supplies abroad since the supplies can be of REVERSE POLARITY. The significance of REVERSE POLARITY is that when equipment is switched off it may not be electrically isolated.

The only certain way of making equipment safe is to unplug it.

If electrical polarity indication is not included in your vehicle electrical equipment, it is useful to have a means of checking polarity of the mains supply, especially when touring overseas.

There are several proprietary makes of equipment available for the purpose.

If it can be achieved, it is preferable to connect live to live, and neutral to neutral to maintain full electrical protection.

CHECK all vehicle equipment is set-up to accept the site supply before actually switching on.

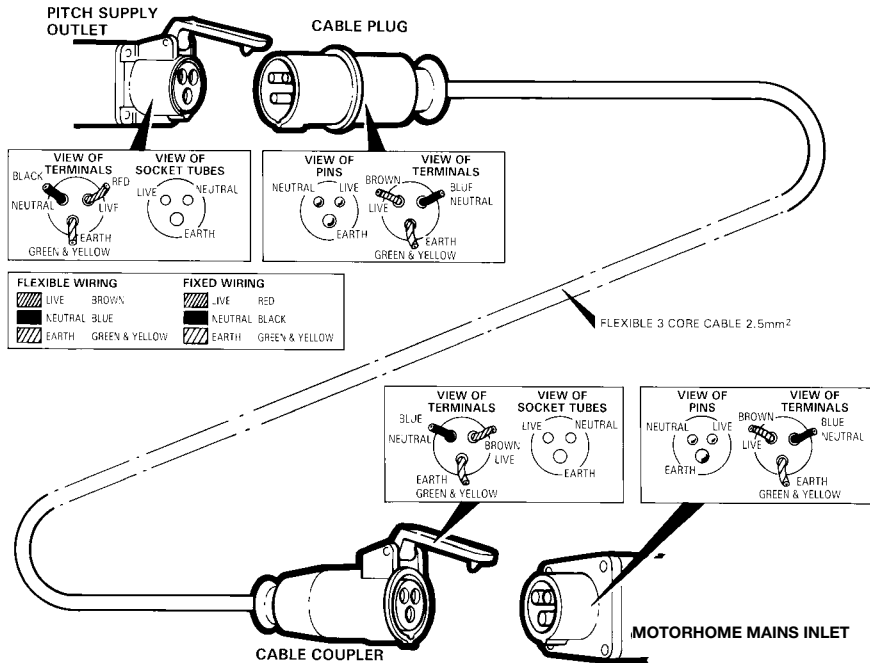

## Warning

It is essential that connections are made exactly as shown. If terminal markings are not in accordance With the diagram they must be ignored. If in doubt consult a qualified electrician. The legal length of the mains inlet cable is  $25 \pm 2$  metres. When in use it must be fully uncoiled and protected from traffic.

## Connecting services

### **230V MAINS ELECTRICAL EQUIPMENT POWER CONSUMPTION**

**Please note:**

It is possible that the 230V mains electrical equipment may not all operate simultaneously. A typical UK motorhome site mains hook up point provides a maximum output of 10 amps and on some continental sites the available output may be as low as 5 amps.

If your loading exceeds the site supply it may trip the site circuit breaker. Please check the available mains output with your site operator.

Similarly loadings on each circuit breaker within the vehicle should be observed

A label positioned close to the MCB's will identify which appliances within the vehicle are fed from which MCB. Consulting the table (Typical Appliance Consumption Figures) in conjunction with this label, will give an indication of which appliances can, and cannot, (site supply allowing), be operated simultaneously.

**WARNING: Never allow modifications of electrical or LPG systems and appliances except by qualified persons.**

## TYPICAL APPLIANCE CONSUMPTION FIGURES

Appliances	230V		12V	Amperes	LP GAS Grams/hour
	Watts	Amperes	Watts		
Dometic Refrigerator	135 W	0.6 amp	Only when driving		11 g/h
Theftord Refrigerator	140 / 200 W	0.6 amp / 0.9 amp	Only when driving		14 / 21 g/h
Ultraheat Space Heater	500 W	2.2 amp	12 W	1.0 amp	30 to 280 g/h
	1000 W	4.3 amp	12 W		
	2000 W	8.5 amp	12 W		
Ultrastore Water heater	850 W	3.7 amp	Not applicable		120 g/h
Combi 4 Combination Boiler	2000 W	8.5 amp	67W	Max 5.6 amp	160 - 320 g/h
Combi 6 Combination Boiler	2000 W	8.5 amp	67W	Max 5.6 amp	160 - 480 g/h
Cooker	Hotplate 1	Not applicable		Not applicable	161 g/h
	Hotplate 2	Not applicable		Not applicable	110 g/h
	Hotplate 3	Not applicable		Not applicable	73 g/h
	Hotplate 4	800 W	3.5 amp	Not applicable	
Grill	Not applicable		Not applicable		117 g/h
Oven	Not applicable		Not applicable		125 g/h
Battery Charger 300w	500 W	2.2 amp	Not applicable		Not applicable
Lighting 12V (based on 10 W bulb)	Not applicable		10 W	0.8 amp	Not applicable
Water pump	Not applicable		48 W	4 amp	Not applicable
Radio/ CD player	Not applicable		12 W	1.0 amp	Not applicable
Cooker Hood	Not applicable		30 W	2.5 amp	Not applicable
Dometic Air Conditioning unit	1200 W	5.25 amp	Not applicable		Not applicable
Microwave (factory fit)	1000 W (approx)	4.3 amp	Not applicable		Not applicable
Fresh + Waste Tank Heater(S)	Not applicable		30W	2.5amp	Not applicable
Cab Area Drop Down Monitor	Not applicable		3amp		Not applicable
Battery Charger 250W	440W	1.9amp	Not applicable		Not applicable

Note: These are approximate figures for guidance only.



# ELECTRICAL SYSTEMS

<b>Motorhome battery</b> .....	<b>52</b>
<b>Fault finding</b> .....	<b>52</b>
<b>Solar panel connection point</b> .....	<b>53</b>
<b>EC Series Power Control Unit</b> .....	<b>54</b>
<b>Generator usage</b> .....	<b>67</b>
<b>Habitation relay</b> .....	<b>67</b>

# Electrical systems

## MOTORHOME BATTERY

It is recommended that a good quality leisure battery is always in circuit when the system is in use.

A deep cycling rechargeable heavy duty 12v battery should be used to provide power for lights and other electrical appliances. A proprietary brand leisure battery with a minimum 85amp - 110 amp capacity is recommended.

Note: 85amp - 110 amp batteries and above should be checked dimensionally before purchasing, to ensure fitment within the battery compartment, as brands vary in size.

It should be remembered that batteries suitable for the electrical demands of a motorhome differ in design from those for use with a car, and whilst the system may operate with a car battery it is strongly recommended that only a rechargeable leisure type battery, maintained in good condition is used. The battery should be kept topped up at all times.

If two leisure batteries are fitted additional care is needed, as one battery deteriorates this can reduce the lifespan of the other.

The battery or batteries should be positioned in the appropriate compartment, which is vented to the outside, and be properly secured before travelling.

**WARNING: When connecting the battery, ensure that the correct polarity is observed (black is negative and red/brown is positive) and that the terminals are securely fastened.**

Under normal circumstances it should not be necessary to remove the battery other than for routine inspection of terminals and 'topping up'.

**WARNING: Explosive gases may be present at the battery. Take care to prevent flames and sparks in the vicinity.**

Your motorhome has been fitted with an in-line fuse between the battery terminal and strip connector. It is recommended that the fuse rating fitted in this location does not exceed 20 amps per battery.

**WARNING: Switch off all appliances and lamps before connecting or disconnecting the battery.**

**Smoking is prohibited around the battery compartment.**

To preserve the life of your leisure battery and charger please observe the following:

- i) Do not leave all 12v lights powered at the same time as this will drain your leisure battery more rapidly.

- ii) If all 12v lights must be powered together, ensure the battery is 'in-circuit' and that the battery charger is turned on.
- iii) For optimum performance use the transformer/charger unit with a leisure battery attached.

Please note the auxiliary battery or batteries supplied with your motorhome may not be fully charged and should be charged for a minimum of 24 hours before use.

Battery performance may be affected by a number of things such as ambient temperature, age, state of charge etc.

## FAULT FINDING

### 1. Mains supply

If mains supply is not available when mains switch and MCBs are switched on, check supply at site distribution and/or mains lead and connections. See Control Panel information for reverse polarity indication.

### 2. Earth faults or MCB tripped

See RCD/MCD Section.

### 3. Charger fails to provide output

Check mains supply as for No.1 and 2.

### 4. Battery discharged or not charging with charger on

Check battery terminals.



### 5. **12V distribution circuit failure**

Check and replace relevant DC output fuse as required.

6. Consult the manufacturers regarding any further difficulties, in particular those related to mains voltage section.
7. There are no user-serviceable or replacement parts in the consumer unit. All service of this nature should be referred to the manufacturers.

**Note: Never use a mains supply lead whilst coiled. Always uncoil the full length before connecting to the supply and remember to protect the cable from traffic.**

## SOLAR PANEL CONNECTION POINT

In all cases a solar panel must provide a fused and regulated output in order to utilise connection points provided in the motorhome harness. A kit of parts is available from your motorhome supplier, which provides the mating half of the connector (The White rectangular connector found inside the motorhome is a two way JST-LP type connector). For further assistance in identifying the connection, wire colours leading to the connector are detailed in the wiring schematic in your motorhome service book.

Solar panel installations should be undertaken by trained technicians who are familiar with

the systems involved. Particular care should be taken when making connections to solar panels, which can generate high voltages ahead of a regulator when exposed to light.

Depending upon the specification of the motorhome, the connection point will be presented in one of the following formats:

### **Solar panel connection point – With EC400 series control panel and related power supply unit**

In these installations two way connectors will be present close to the leisure battery, and/or at a high level within the furniture (i.e. within a wardrobe, either visible or behind a removable cover).

From these connectors the supply is taken to the power supply unit, and is then directed to the leisure battery and/or vehicle battery. For further details of selecting which battery receives the solar charge, please see the EC400 series instructions.

### **Solar panel connection point – With EC400 series control panel and related power supply unit, and with roof mounted solar panel connection point**

On some models, in addition to the connections detailed above which take a regulators output to the power supply unit, an additional harness and external connection box has been fitted. The intention of this link harness is to provide an electrical route between the inside of the

motorhome body, and a solar panel installation on the roof of the motorhome.

The connection box can be located towards the front of the motorhome roof and within this connection box is a two way weatherproof connector, to which a solar panel or panels can be connected directly.

Within a high level furniture locker, relatively close to the external connection box, two connectors will be found. The first is the other end of the link harness from the roof mounted connection box, this should be connected to the input connections of a solar panel regulator, and the second connector should be connected to the output from the regulator. A Brown and Blue pair of wires will feature in the link from the roof providing the input, with a Red and Black pair of wires taking the regulator output to the power supply unit.

# Electrical systems

## EC450 POWER SUPPLY UNIT (PSU)

### 1 Introduction

This section of the handbook will guide you through the operation of the electrical system.

Further technical information is available from Sargent Electrical Systems (01482 678981).

For the safe operation of all electrical equipment within your caravan it is important that you read and fully understand these instructions. If you are unsure of any point please contact your dealer for advice before use.

The system has a number of key components that you will need to be familiar with before attempting to use the system, these are:

- The Power Supply Unit (PSU) - a combined mains consumer unit, 12V controller.
- The Control Panel (CP) - a remotely located user control panel used to turn circuits on and off and to display battery and water tank information. This panel is uses simple straightforward controls and reliable data communication to the PSU.

### 2. Using the System

#### 2.1 Power Supply Unit

##### - Component Layout

The PSU is located either in the lower bed or upper locker.

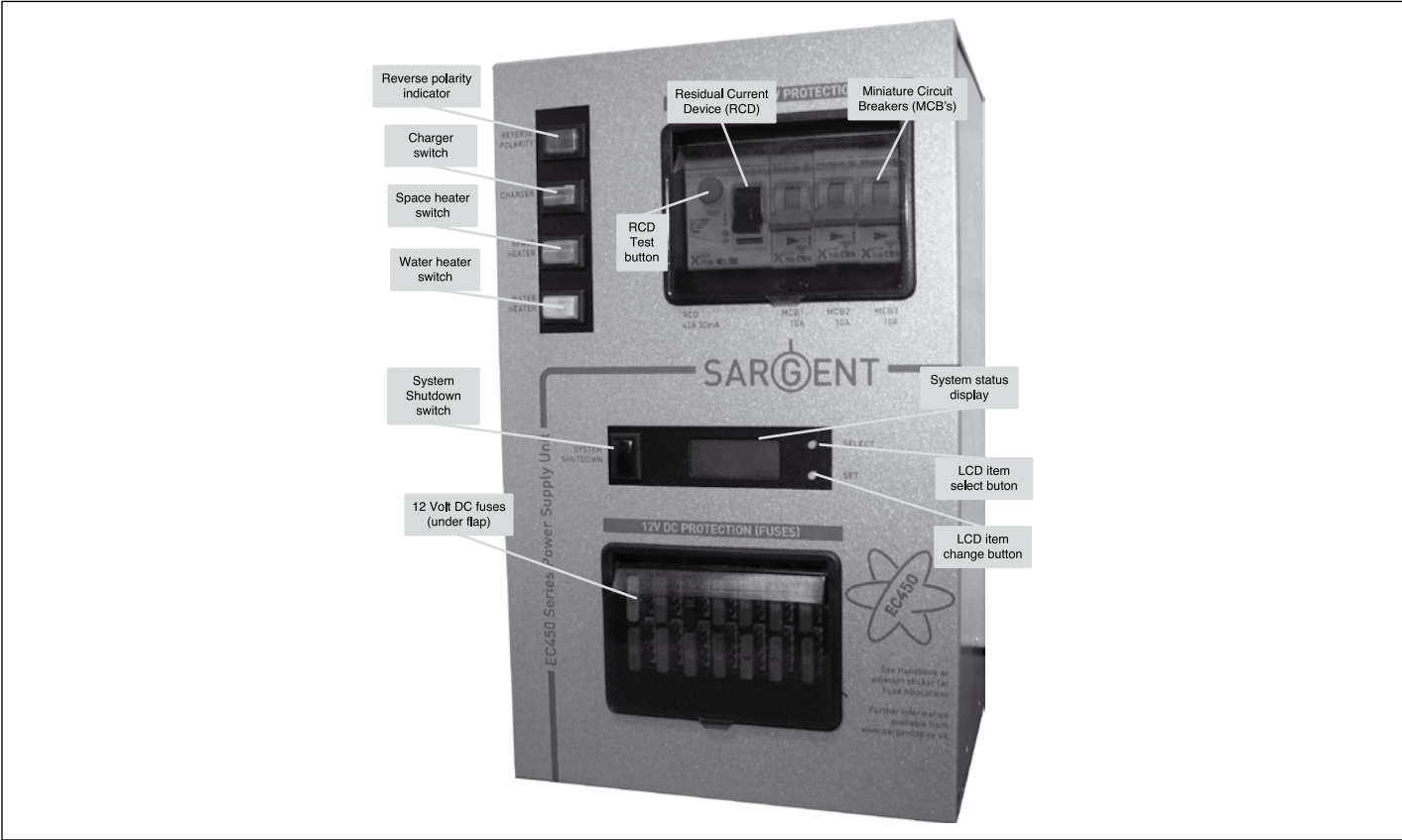

# Electrical systems

## 2.2 Activating the System

The EC Series system has a shutdown feature that can be used when the vehicle is in storage. This allows the leisure electronics to be turned off when not required to save battery power. When in the off state the alarm and tracking system supplies are still active, all other supplies are turned off. Before using the system, please ensure the system shutdown switch is in the 'On' position (i.e. in)

## 2.3 System Status and Configuration Display

On the PSU, the unit contains an LCD display (model specific) and two control buttons that allow system information to be viewed.

Press the top yellow 'select' button to change the item being viewed. Press the bottom red 'change' button to change the setting.

If you want to return to an item or setting then hold the button until the required item or setting is displayed.

Before using the system please ensure the system 'Isolate' switch is in the on position (button in).

## 2.3 Connecting to the Mains 230V supply and Safety checks

For your safety it is IMPORTANT that you follow these connections instructions each time your Leisure Vehicle is connected to a mains supply. This section assumes that the system is complete and that a Leisure battery has been installed (see 3.4).

A) Ensure suitability of the Mains Supply. Your Leisure Vehicle should only be connected to an approved supply that meets the requirements of BS7671 or relevant harmonised standards. In most cases the site warden will hold information regarding suitability of supply. If using a generator you also need to comply with the requirements / instructions supplied with the generator. Please note that some electronic generators may not be compatible with your leisure system. Further generator operational information is contained elsewhere in this manual (page 76).

B) Switch the PSU Power Converter to OFF.

Locate the green 'Charger' power switch on the PSU and ensure the switch is in the off position (button out) before connection to the mains supply.

C) Connect the Hook-up Lead.

Connect the supplied hook-up lead (orange cable with blue connectors) to the caravan and then connect to the mains supply.

D) Check Residual Current Device operation.

Locate the RCD within the PSU and ensure the RCD is switched on (lever in up position). Press the 'Test' button and confirm that the RCD turns off (lever in down position). Switch the RCD back to the on position (lever in up position).

E) Check Miniature Circuit Breakers.

Locate the MCB's within the PSU (adjacent to the RCD) and ensure they are all in the on (up) position.

F) Turn the PSU ON.

Locate the black 'Isolation' button and ensure it is in the on position (press button in). Locate the green 'Charger' switch on the PSU and turn to the on position (press button in). The charger switch will illuminate when turned on.

G) Check correct Polarity.

Locate the 'Reverse polarity' indicator on the PSU and ensure that the indicator is NOT illuminated.

H) Check operation of equipment.

It is now safe to operate the 12v and 230v equipment.

## 2.4 Control Panel - Component Layout

Depending on your type of vehicle the control panel will vary in specification. Not all features are present in all vehicles. Please refer to the following diagrams to identify your control panel.

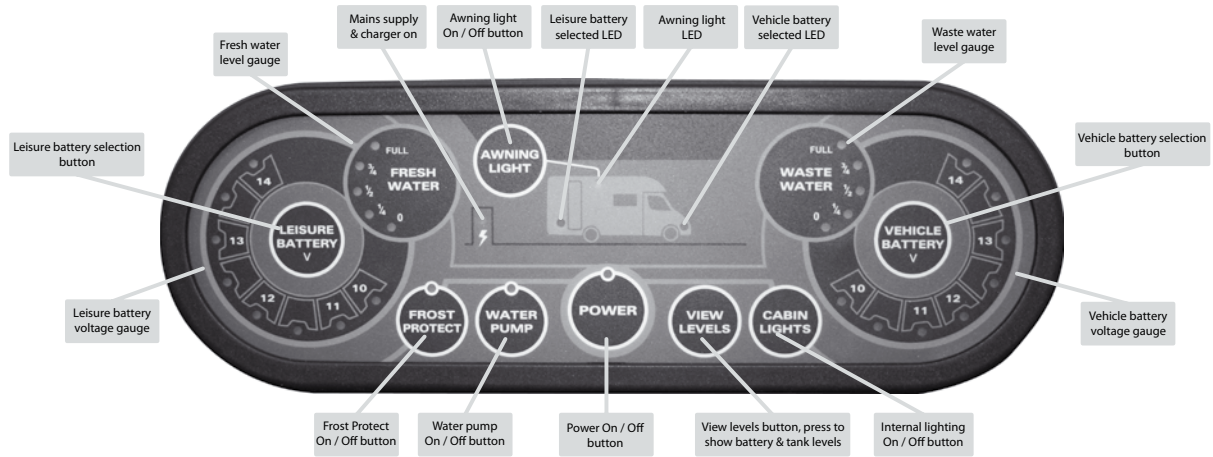

EC467 Motorhome Control Panel

# Electrical systems

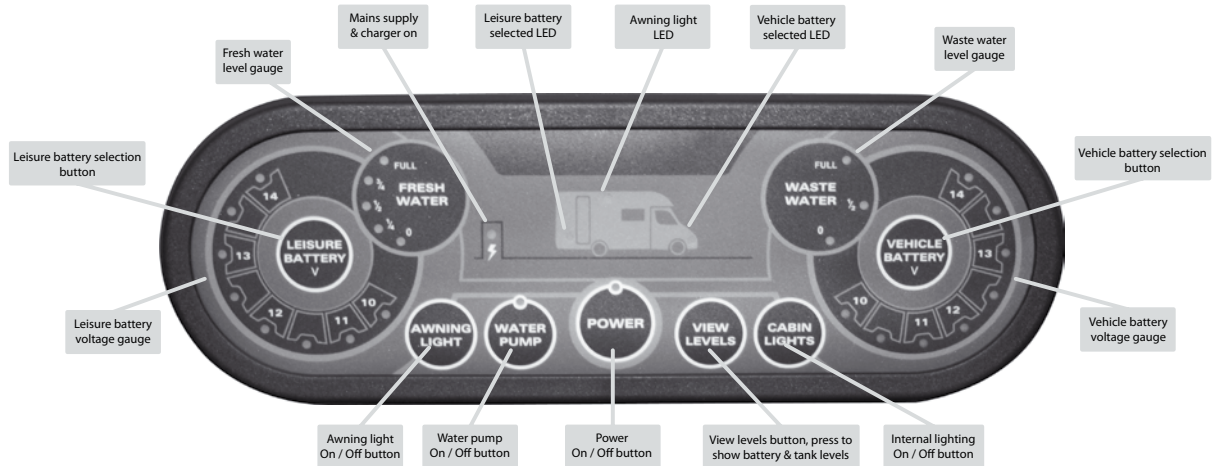

EC462 Motorhome Control Panel

## 2.5 Control Panel Operation

- **Power Button.** Press the power button to turn the leisure power on. Press the button again to turn the power off. The adjacent LED will illuminate when the power is on, and also the voltage of the selected battery will be displayed on the voltage gauge.

- **Pump Button.**

With the power on, press the pump button to turn the water pump on. Press the button again to turn the pump off. The adjacent LED will illuminate when the pump is on, and also the level of the water tank will be displayed on the water gauge.

- **Water Level Indicator.**

For caravans with an internal fresh water tank, a warning will sound if the water level drops below 25%. The fresh water gauge LED will also light. To cancel the warning, press the levels button.

- **View Levels.**

Press and hold the view levels button to permanently display the level conditions.

To display the battery voltage levels and the water tank levels on the control panel gauges, press the levels button.

The display will remain illuminated for 10 seconds.

- **Battery Select.**

By default, the leisure battery is selected as the power source if no mains supply is present, or as the battery to be charged when the mains supply is available. To change the selected battery, press the battery select button. The selected battery is indicated by an LED adjacent to the caravan or car logo (for caravans) or the LED situated in the centre of the leisure and vehicle battery gauges.

## 2.6 Operation while driving

The EC Series system is designed to shutdown parts of the system while the engine is running. This is to meet Electro Magnetic Compatibility (EMC) regulations and to ensure the safe operation of the caravan.

Please ensure the system isolation switch on the PSU is in the on (button in) position before driving (see 2.2). This will ensure the electronic system is active and will therefore be able to control the charging process, supply the refrigerator and monitor other system circuits.

## 3. System Technical Information

The following section provides further technical information relating to the electrical system. You can also access the supporting technical manual from [www.sargentltd.co.uk](http://www.sargentltd.co.uk)

## 3.1 Residual Current Device & Miniature Circuit Breakers

The Residual Current Device (RCD) is provided to protect the user from lethal electric shock. The RCD will turn off (trip) if the current flowing in the live conductor does not fully return down the neutral conductor, i.e. some current is passing through a person down to earth or through a faulty appliance.

To ensure the RCD is working correctly, the test button should be operated each time the vehicle is connected to the mains supply (see section 2.3).

The Miniature Circuit Breakers (MCB's) operate in a similar way to traditional fuses and are provided to protect the wiring installation from overload or short circuit. If an overload occurs the MCB will switch off the supply. If this occurs you should investigate the cause of the fault before switching the MCB back on.

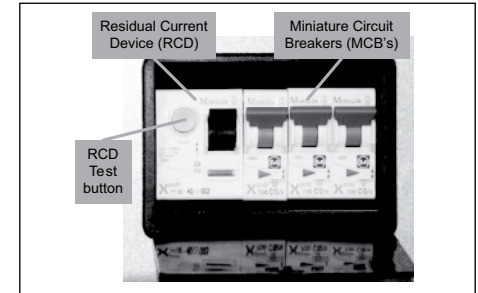

# Electrical systems

The following table shows the rating and circuit allocation for the three MCB's

MCB	Rating	Output Wire Colour	Description
1	10 Amps	White	230v Sockets
2	10 Amps	White (Yellow for Heater)	Extra 230v Sockets/Space Heater
3	10 Amps	Black (Blue for water heater)	Fridge/Water Heater/12v Charger

## 3.2 Battery Charger

During stage 1 the battery voltage is increased gradually while the current is limited to start the charging process and protect the battery. At stage 2 the voltage rises to 14.4V to deliver the bulk charge to the battery. When the battery is charged, the voltage is decreased at stage 3 to 13.6V to deliver a float charge to maintain the battery in the fully charged state. The charger can be left switched on continuously as required.

The battery charger / power converter also provides power to the leisure equipment when the mains supply is connected. This module supplies DC to the leisure equipment up to a maximum of 25 Amps (300 Watts), therefore the available power is distributed between the leisure load and the battery, with the leisure load taking priority as per the following example:

Leisure load	Available power for battery charging
5A	20A
10A	15A
15A	10A
20A	5A



Battery	Voltage cut off	Action after cut off	Notes
Vehicle	10.9v	Battery selection is changed from Vehicle battery to Leisure battery. If the leisure battery is below 9v then a further warning will occur (see below).	This cut off level is designed to protect the vehicle battery from over discharge. The 10.9v level ensures there is sufficient power in the battery to run the vehicle electronics and start the vehicle. This cut off only applies to power drawn from the battery by the leisure equipment; it will not protect the battery if you leave vehicle circuits switched on, such as the road lights.
Leisure	9v	Power is turned off	This is an emergency cut off level to protect the battery from severe damage. You should not rely on this cut off level during normal operation, but manage your power consumption to a discharge level of 10v. This cut off only applies to power drawn from the battery by the leisure equipment that is controlled by the control panel power switch; it will not protect the battery from discharge by permanently connected equipment.

# Electrical systems

## 3.3 12 Volt DC Fuses

**WARNING: When replacing fuses always replace a fuse with the correct value. NEVER replace with a higher value / rating as this could damage the wiring harness. If a replacement fuse 'blows' do not keep replacing the fuse as you could damage the wiring harness. Please investigate the fault and contact your dealer.**

The following table shows the fuse allocation for the 15 fuses fitted to the PSU. Please note that fuses are dependant on PSU versions, so not all fuses may be present.

Fuse	Rating	Fuse Colour	Description
1	20 Amps	Yellow	Motorhome Fridge
2	15 Amps	Blue	Motorhome Towing
3	7.5 Amps	Brown	Motorhome Marker Lights
4	15 Amps	Blue	Motorhome Fridge D+
5	10 Amps	Red	Fans
6	10 Amps	Red	12V Sockets
7	10 Amps	Red	Front Internal Lights
8	10 Amps	Red	Water Pumps
9	15 Amps	Blue	Electric Step
10	10 Amps	Red	Motorhome Tank Heaters
11	10 Amps	Red	Auxiliary Supplies
12	5 Amps	Tan	Electronics
13	5 Amps	Tan	Ignitions
14	10 Amps	Red	Rear Internal Lights
15	25 Amps	Clear	Charger (fitted internally to PSU)

The following table shows details of the fuse(s) located at the Leisure battery. See also 3.4A

<b>Fuse</b>	<b>Rating</b>	<b>Fuse Colour</b>	<b>Description</b>
Battery 1	20 Amps	Yellow	Fuse remotely located near battery
Battery 2	20 Amps	Yellow	Fuse remotely located near battery 2 (where fitted)

# Electrical systems

## 3.4 Common Fault Table

Fault	Possible Cause		Proposed Fix
No 230 volt output from PSU	Connecting lead between the site and Leisure Vehicle not connected		as per 2.3C
	RCD switched off		Reset RCD
	RCD not operating correctly		Check supply polarity; if the RCD continues to fail contact your Dealer as there is probably an equipment or wiring fault.
	MCB switched off		Reset MCB by switching OFF (down position) then back ON (up position), if the MCB continues to fail contact your Dealer as there is probably an equipment or wiring fault.
	No or deficient supply from site		Contact site Warden for assistance
	Other fault		Contact your Dealer
Reverse Polarity light is illuminated on PSU	Mains Supply reversed?	The reverse polarity light is designed to illuminate when the Live and Neutral supply has been reversed / crossed over. If the light illuminates there is a problem with the site supply or the cable connecting the supply to your vehicle. The light is designed to work on UK electrical supplies (where the neutral conductor is connected to earth at the sub station). If you are using your vehicle outside the UK this light may illuminate when no fault exists. In these cases consult the site warden for advise.	
	Generator being used	‘The Reverse Polarity warning light is on when using my Generator’. This is a normal side effect when using some types of generator. Instead of connecting the neutral conductor to earth, some generators centre tap the earth connection making both neutral and live conductors 110v above earth. This 110v difference causes the neon polarity indicator to illuminate. In most cases it is still safe to use the generator, but please consult the generator handbook for further information.	

Fault	Possible Cause	Proposed Fix
Control Panel Problems	Control Panel has no display	Check batteries and fuses, turn PSU isolate switch and charger switch on and ensure mains supply is connected. Check control panel connecting lead at PSU and behind Control Panel Contact your Dealer
	12v Power turns off	Battery protect feature has operated to protect the Vehicle battery and or the Leisure battery. Engine has been started, all equipment has been disconnected to meet EMC requirements.
	Control Panel locked / erratic function	Observe control panel handling instructions Control panel software may have crashed. Reboot control panel by turning off the PSU isolate switch. Wait 30 seconds then turn the switch back on.

# Electrical systems

Fault	Possible Cause	Proposed Fix
No 12 volt output from PSU	No 230v supply	Check all above
	Charger not switched on	Turn charger switch on, switch will illuminate
	Battery not connected and / or charged	Install charged battery
	Power button on control panel not switched to on	Turn power on at control panel
	Battery flat / Battery fuse blown	Recharge battery, check fuses, check charging voltage is present at battery
	Fuse blown	Check all fuses are intact and the correct value fuse is installed as per fuse table
	Equipment switched off / unplugged	Check equipment is switched on and connected to the 12v supply
	PSU overheated / auto shutdown operated	Reduce load on system. Allow PSU to cool down. PSU will automatically restart when cool.
	Other fault	Contact your Dealer
Pump not working	Fuse blown	Replace fuse with correct value as per fuse table.
	Pump turned off	Turn pump on by pressing the pump button at the control panel.
	Setting incorrect	Both the internal and external pump feeds are controlled from the control panel. To alter the setting of the pump switch Ensure the setting matches your desired requirement.

### 3.5 Contact details

Sargent Electrical Services Limited provide a technical help line during office hours. Please contact 01482 678981 if you require technical help. For out of hour support please refer to the tech support section of the Sargent web site [www.sargentltd.co.uk](http://www.sargentltd.co.uk)

## GENERATOR USAGE

Caution should be used before connecting a generator to your motorhome.

**Warning: Never start or stop the generator while electrical loads are connected and switched on. Start the engine, let it stabilise, then connect the electrical load. To stop engine, disconnect the electrical load and let engine stabilise before switching off.**

Whilst some generators use inverter technology, others use a more basic principle to generate the 230v supply. Preference should be to choose a generator which produces a consistent sinusoidal wave form with accurate voltage control.

The reverse polarity warning light may illuminate when using a generator. This is a normal side effect when using some types of generator. Instead of connecting the neutral and live conductors 110v above earth. This 110v difference causes the neon polarity indicator to illuminate.

In most cases it is safe to use a generator, but please consult the generator handbook for further information.

## HABITATION RELAY

Habitation relays are fitted to caravans by manufacturers to comply with the following legislation:

1. The Road Vehicles (Construction and Use) Regulations 1986 Regulation 60 - Radio interference suppression
2. Council Directive 72/245/EEC of June 20, 1972 amending for the purpose of their adaptation to technical progress, relating to the radio interference (electromagnetic compatibility) of vehicles and Council Directive 70/156/EEC on the approximation of the laws of the Member States relating to the type-approval of motor vehicles and their trailers.

A habitation relay must be fitted by manufacturers, safe guarding the consumer, the purpose of the relay is to disable non-homologated appliances/components whilst the vehicle is in transit.

Unintentional electromagnetic energy can be created by non-homologated devices within the habitation compartment, could cause a malfunction of the base vehicles electronic systems/components, including safety critical items such as air bags, ABS braking etc.





# EQUIPMENT DETAILS

<b>Truma ultra-store water heater . . . . .</b>	<b>71</b>
<b>Truma S 3002 auto space heater. . . . .</b>	<b>75</b>
<b>Truma Ultraheat additional electric heating . . . . .</b>	<b>77</b>
<b>Teb fan . . . . .</b>	<b>78</b>
<b>Truma Combi 4 / Combi 6 . . . . .</b>	<b>79</b>
<b>Alde Compact 3010 heating . . . . .</b>	<b>91</b>
<b>Inboard water tanks and on-line water systems . . . . .</b>	<b>108</b>
<b>Flojet automatic water system pump . . . . .</b>	<b>108</b>
<b>Refrigerators . . . . .</b>	<b>110</b>
<b>Spinflo cooker . . . . .</b>	<b>122</b>
<b>Spinflo cooker 3 burner . . . . .</b>	<b>128</b>
<b>Extractor hood 524 . . . . .</b>	<b>131</b>
<b>Microwave oven . . . . .</b>	<b>132</b>
<b>Thetford Cassette Toilet . . . . .</b>	<b>135</b>
<b>Thetford C250 CWE and C250CS cassette toilet . . . . .</b>	<b>139</b>
<b>Windows . . . . .</b>	<b>144</b>
<b>Komfortrollo blinds (Seitz) . . . . .</b>	<b>144</b>
<b>Roof lights . . . . .</b>	<b>145</b>
<b>Skyview operating instructions . . . . .</b>	<b>146</b>
<b>Blind and flyscreen . . . . .</b>	<b>148</b>
<b>Seat swivel . . . . .</b>	<b>149</b>

# EQUIPMENT DETAILS

<b>Side lockers</b> .....	<b>149</b>
<b>Bunk and luton bed safety</b> .....	<b>149</b>
<b>Furniture doors</b> .....	<b>149</b>
<b>Ash framed doors</b> .....	<b>149</b>
<b>Tables</b> .....	<b>149</b>
<b>Table storage</b> .....	<b>150</b>
<b>Shower</b> .....	<b>150</b>
<b>Care of laminate tops, tables, furniture and doors</b> .....	<b>150</b>
<b>12V Reading lamp</b> .....	<b>150</b>
<b>Omnistep single step</b> .....	<b>150</b>
<b>Omnistep slide out step</b> .....	<b>151</b>
<b>Omnistep double step</b> .....	<b>152</b>
<b>Manually operated entrance step</b> .....	<b>153</b>
<b>Fiamma F45i side awning</b> .....	<b>153</b>
<b>Fiamma F65 roof mounted awning</b> .....	<b>155</b>
<b>Status 530 directional TV and FM radio antenna</b> .....	<b>156</b>
<b>CD/MP3 player</b> .....	<b>157</b>
<b>Reverse camera function</b> .....	<b>157</b>
<b>LCD TV/DVD/CD/MP3/DVB unit</b> .....	<b>157</b>
<b>Motorhomes with external co-ax connection</b> .....	<b>157</b>

## Equipment details

The cassette has a capacity of 10 litres.

**Attention: Always fit the cowl cap when the water heater is not being operated! Drain the water heater if there is risk of frost and preferably when you leave the site. Leave all taps open. Frost damage is not covered by the warranty!**

### Filling the Truma-Ultrastore with water

1. Check that the safety/drain valve in the cold water intake is closed. Lever should be in horizontal position, position (e) Fig. 1.

e = Lever position  
'Closed'

f = Lever position  
'Drain'

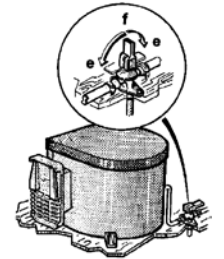

Fig. 1

2. Open hot tap in bathroom or kitchen; set pre-selecting mixing taps or single lever fittings to 'hot'.
3. Switch on power for water pump. Leave the tap open to let air escape while the water heater is filling. The heater is full when water flows freely from the tap.

The instructions covering fitted equipment to your vehicle were correct at the time of going to print. Owners handbooks are updated annually and we take great care to try and ensure their accuracy. However, the Swift Group Limited cannot accept responsibility for any changes that may be made in specification or operating instructions to the equipment described in this section after the time of going to press.

Every care is taken to ensure that the information provided in this handbook is correct and easy to understand.

Separate manufacturers' leaflets on many of the components are also included in the Owner's Pack provided with this vehicle and we recommend that you compare the instructions in the handbook with the component manufacturers literature, to ensure the information provided is as accurate as possible.

If you are in any doubt as to how to operate the equipment in your vehicle, please contact the component manufacturer's service department on the telephone number shown on their component leaflet. If you remain in any doubt, please contact the Swift Group Supercare customer care service department on 01482 875740.

### Equipment Specification

For details on type of equipment fitted in your vehicle, please refer to the Sales Brochure or Dealer.

### IMPORTANT

To maximise the use and life of all fitted equipment in your vehicle it is essential that any accompanying manufacturers' literature is read fully. All recommended maintenance and preparation procedures should be followed. The information provided in this handbook is only intended as a guide. If in any doubt consult your manufacturer appointed dealer, particularly before attempting to install EXTRA EQUIPMENT.

**NOTICE: In the interest of safety, replacement parts for an appliance shall conform to the appliance manufacturer's specifications and should be fitted by them or their authorised agent.**

## TRUMA ULTRA-STORE WATER HEATER

**The water heater features a system that will heat water using liquid petroleum gas or 230V mains electricity. The heater can be simultaneously operated on gas and electricity to give a faster warm-up period.**

## Equipment details

Residues of frozen water can prevent filling if there is a frost. The water heater can be defrosted by switching on the heater for a short period (max 2 mins). Frozen pipes can be defrosted by heating the room.

**Note: If just the cold water system is being used, without water heater, the heater tank is also filled up with water. In order to avoid damage through frost, the water contents must be drained by actuating the safety/drain valve, also when the heater has not been used. As an alternative, two shutoff valves, resistant to hot water, can be fitted in front of the cold and hot water connection.**

### Draining the water heater

1. Disconnect power for water pump (control panel).
2. Open hot water taps in bathroom and kitchen.
3. Open safety/drain valve: Lever in vertical position, position (f).
4. The water heater is now drained directly to the outside via the safety/drain valve. Check that the water contents have been completely drained (10 litres).

## GAS OPERATING INSTRUCTIONS

**Attention: Never operate the water heater without water in it! If the wall cowl is positioned close to an opening window (or hatch) - in particular directly under it - it must remain closed when the water heater is in use (see warning plate).**

1. Remove cowl cover.



2. Open gas cylinder and open quick-acting valve in the gas supply line.

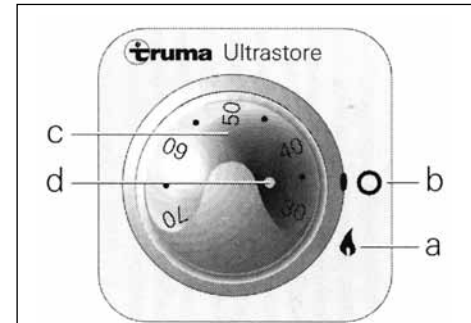

**a = Rotary switch 'On' 'Gas operation'**  
**b = Rotary switch 'Off'**  
**c = Rotary knob for temperature selection (illuminated by green lamp 'Operation')**  
**d = Red indicator lamp 'Failure'**

3. Switch the water heater on at the rotary switch (a) of the control panel, and the green monitor lamp will light up. Set the desired water temperature at the rotary knob (c) (steplessly adjustable from about 30°C to 70°C).
4. If there is air in the gas supply line, it may take up to a minute before the gas is available for combustion. If the appliance switches to 'Failure' during this period, switch off the appliance - wait 5 minutes - and switch on again!

## Equipment details

### Switching off (gas operation):

Switch off the water heater at the rotary switch (b).

**Drain the water heater if there is a risk of frost!**

If the water heater is not to be used for a longer period, mount cowl cover (non-observance of this point can lead to the function of the appliance being impaired through water, dirt or insects), close quickacting valve in the gas supply line and close the gas cylinder.

**There shall be no claim under guarantee if this point is not observed.**

**Always remove the cowl cover prior to operating the water heater!**

### Red indicator lamp 'Failure'

The red indicator lamp (d) lights up if there is a failure. The reason for such an indication is, for example - cowl cover fitted, no gas available or air in the gas supply system, triggering of the excess temperature monitor etc.

To unlock, switch off the appliance, wait 5 minutes, and switch on again.

**In event of faults, always contact Truma Service on Tel: 01283 511092.**

## ELECTRICAL OPERATING INSTRUCTIONS

**Attention: Do not operate the water heater without water in it!**

Press the switch on the fused spur to ON. The indicator lamp indicates that the heater is switched on.

Switch the electric supply on at the fuse spur marked Water Heater, normally in the wardrobe.

Note: The water temperature cannot be selected, automatic temperature limitation at approx. 70°C. For a faster heating up period the appliance can be simultaneously operated with gas and electrical power.

Note: The water tank in the Truma-Ultrastore is made of high quality food-proof stainless steel VA.

Use wine vinegar for de-scaling the water supply. Allow the product to react and then thoroughly flush out the appliance with plenty of fresh water. To sterilise the water we recommend 'Certisil- Argento'. Other products, particularly those containing chlorine are unsuitable.

In order to avoid the proliferation of micro-organisms, heat the Ultrastore to 70°C at regular intervals.

**Do not use the water as drinking water!**

## Important Operating Notes

1. If the cowl is positioned close to an opening hatch (window), keep this closed during operation. See warning plate. Always mount the cowl cover if the heater is not being used. Non-observation of this point can lead to the function of the appliance being impaired through water, dirt or insects.
2. The guarantee will be invalidated if this point is not observed. Always remove the cowl cover prior to operating the water heater!
3. If there is a defect in the electronics, return the control Printed Circuit Board well padded. If you fail to pack it correctly the guarantee will be invalidated. Only use original Truma Ultrastore control PCBs as spare parts.
4. If just the cold water system is being used, without water heating, the header tank becomes more vulnerable to frost damage. Accordingly the contents should be drained by operating the safety/drain valve. This also applies when the vehicle is in storage.

### General safety notes

If the gas system is leaking or if there is a smell of gas:

- Extinguish all naked flames.
- Do not smoke.
- Switch off the appliances.

## Equipment details

- Shut off the gas cylinder.
  - Open the windows.
  - Do not actuate any electrical switches.
  - Have the entire system checked by an expert.
1. Repairs may only be carried out by an expert.
  2. The following will invalidate the guarantee:
    - a) Any alteration to the appliance, including the cowl.
    - b) The use of non-original Truma parts/accessories.
    - c) Non-observance of the Operating Instructions.
  3. The operating pressure for the gas supply is 30 mbar and must correspond to the operating pressure of the appliance (see data plate).

**Liquid gas systems must comply with the technical and administrative regulations of the respective country of use (e.g. EN 1949 for vehicles in Europe).**

**A qualified technician must inspect/test according to EN 1949 every two years and a certificate issued.**

The vehicle owner is always responsible for arranging the inspection.

4. Do not operate the water heater when refuelling the vehicle and when in the garage.

5. During the initial operation of a brand new appliance (or after it has not been used for some time), a slight amount of fumes and a certain smell may be noticed for a short while. Remedial action is to immediately run the heater at maximum output and to ensure adequate room ventilation.
6. If the burner makes an unusual noise or if the flame lifts off, it is likely that the regulator is faulty and it is essential to have it checked.

### Technical data

**Water contents:** 10 litres

**Water pressure:** up to max. 2.8 bar

**Type of gas:** Liquid gas (propane/butane)

**Operating pressure:** 30 m/b

**Rated thermal output:** 1500 W

**Gas consumption:** 120 g/h

**Heating time up to approx. 70°C:**

Gas operation: approx. 35 minutes

Electrical operation: approx. 70 minutes

Gas and electrical operation: approx 20 minutes.

**Power consumption 12 V**

Ignition: 0.17 A

Heating up: 0.08 A

Standby: 0.04 A

**Power consumption 230 V**

Heating up: (2 A) 450 W

Weight (empty): Approx: 6.7 kg

## TRUMA S 3002 AUTO SPACE HEATER

Instructions for heaters fitted with automatic ignitor or piezo ignitor

**Note: Refer to Control Panel NE183 Operating Instructions with regard to Water Heater operation.**

### Switching On

1. Open the valve on the gas cylinder. Open quick-acting valve in gas supply line.
2. Turn control knob to thermostat setting 1-10 and press it down as far as the stop. At the same time keep operating the Piezo ignitor rapidly until the flame ignites.
3. Keep the control knob depressed for a further 10 seconds to allow the safety pilot to operate.
4. (Piezo only) Watch through the flame observation window for another 10 seconds to make sure that the flame does not go out through air in the supply pipe (caused by the valve being closed or changing the cylinder).

**Attention: Always wait at least 2 minutes before attempting to re-ignite, otherwise there is a risk of blowbacks (misfiring). This also applies if a working heater goes out has to be re-lit.**

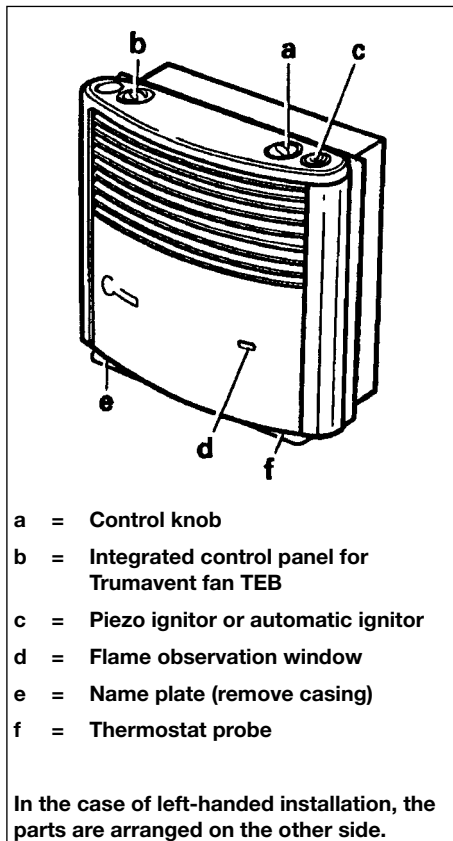

### Automatic Ignitor

Prior to first ignition, make sure that the batteries have been inserted; observe correct fit battery cassette (see changing batteries, page 62).

### Thermostat

Set the required room temperature at the control knob (numbers 1-10). For an average room temperature of approx. 22°C we recommend setting:

- 3-5 Without the Trumavent Fan (switched on)
- 4-8 With the Trumavent Fan

### Switching Off

Set control knob to "0". If turning off for a long period of time, close the quick-acting valve in the gas supply line. Close valve of gas cylinder.

### Important Operating Notes

1. If the gas supply line is filled with air, it may take up to a minute before the gas becomes available for combustion. During this time depress the control knob and continuously operate the Piezo ignitor until the flame ignites.
2. You will have to find out the exact thermostat setting yourself, depending on how much heat you need.
3. Repairs are only to be carried out by a competent service engineer.

## Equipment details

**Attention: A new O-ring must always be installed after dismantling the exhaust duct.**

- Any alteration to the appliance (including exhaust duct and cowl) or the use of spare parts and accessories, which are important to the function of the heater and which are not original Truma parts, as well as the non-observance of the installation and operating instructions, will lead to the cancelling of the guarantee and exclusion of liability claim.
- During the initial operation of a brand new appliance, a certain amount of fumes and a slight smell may be noticed for a short while. Remedial action is to immediately run the heater at maximum output and to ensure adequate room ventilation.
- In winter, before switching on the heater, remove all snow from the cowl.
- Inspect the exhaust duct and all connections at regular intervals and always whenever there is a blowback (misfire). It is essential that the exhaust duct is installed so that it slopes upwards over its whole length and is securely fixed with several clamps. Never place any object on the exhaust duct, since this could result in damage. The exhaust duct connection to both the heater and the cowl must be firm and well sealed.

Do not operate heaters with incorrectly

fitted or damaged exhaust ducts.

- Never allow the warm air outlet on the heater to be obstructed in any way. For instance never hang washing on or in front of the heater to dry. Misusing your heater in this way could cause serious damage from overheating. Do not place flammable objects near the heater. Please follow these guidelines in the interest of your own safety.
- If the burner makes an unusual noise or if the flame lifts off while burning, it is likely that the regulator is faulty and it is essential to have it checked.
- Cleaning (with switched off appliance): It is recommended that at least once a year, before the heating season starts, you remove any dust that has collected on the heat exchanger base plate.

### Technical Data:

Type of gas:	Liquid gas (propane/butane)
Operating pressure:	30mbar (28mbar butane, 37mbar propane)
Rated thermal output:	3400W
Gas consumption:	30-280 g/h
Product Ident.	No: CE-0085AP0325

### Automatic Ignitor

Power consumption: 50 MA (ignition)  
0.01 MA (monitoring)

Operating voltage: 3V

### Changing of batteries

#### Changing the Batteries on the Automatic Ignitor

Only change the batteries with the heater switched off.

Always insert new batteries at the beginning of the heating season.

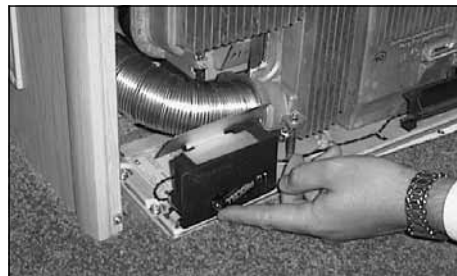

Remove front of heater retaining screw, located through centre of black grill. Unclip front of heater, slide up battery cover to reveal battery. Change the batteries. Observe plus/minus.

Only use temperature resistant (+70°C), leak-proof Mignon round cells (LR 6, AA, AM 3, Art. no. 30010-23600). Other batteries could lead to malfunctions!



## TRUMA ULTRAHEAT ADDITIONAL ELECTRIC HEATING

For Trumatic S 3002 heaters

### Function description

Truma-Ultraheat is an additional 230V electric heater for the LPG heater models Trumatic S 3002/S 5002. Heater operation is basically possible with gas only, electricity only or simultaneously with electricity and gas.

When using simultaneously the electrical unit will switch itself off before overheating occurs as a result of the stronger gas burner.

When using electrical only we recommend to set the fan control on position 3 (manual or auto), remembering to set the output level to 2000W (ensure that the fuse protection for the power supply of the camp site is sufficient).

If more than 2kw are required (heating up/cold temperatures) you must refer back using gas operations as the 230V electrical operation is a secondary heater only.

The electric heater can also be operated without the Trumavent fans.

**WARNING: Due to the design, the heater front case will become hot during operation. The operator is obliged to ensure that due care is taken to protect third parties (small children in particular).**

### Operating instructions

**Before operating the heater for the first time it is essential to observe the operating instructions, enclosed with the heater.**

### Control panel with thermostat

- a = Rotary switch "Off"
- b = Rotary switch "On" power settings:  
500 - 1000 - 2000 W
- c = Rotary control knob for room temperature (illuminated by green indicator lamp "operation")

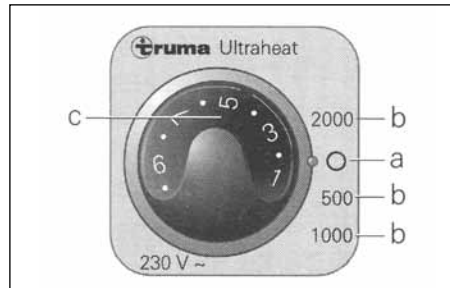

### Switching On

Attention: Before switching on, ensure that the fuse protection for the power supply of the campsite is sufficient for the selected power setting (b) (see Technical Data).

Important: The electric feed line for the caravan must be fully unwound from the cable drum.

1. To switch on, turn the rotary switch to the desired output level (b).
2. Set rotary control knob (c) to the desired room temperature.

The thermostat setting on the operating element (1-9) must be determined individually depending on the heating requirement and the type of vehicle. For an average room temperature of about 23°C, we recommend a thermostat setting of about 6 - 8.

### Switching off

Switch the heating system off at the rotary switch (a).

### Important operating notes

1. Repairs may only be carried out by an expert.
2. The heater's hot air outlet should under no circumstances be blocked. Never hang clothes or similar in front of or on top of the heater to dry. This could cause serious damage to the heater as a result of overheating. Do not place inflammable materials near the heater! Please observe these instructions for your own safety.
3. The performance of the room thermostat will be affected if temporarily covered or obstructed

## Equipment details

- When operating a brand-new heater for the first time (or after it has been idle for a lengthy period) you may temporarily notice a slight smoke and smell. We advise running the heater at full power and thoroughly ventilating the room.
- Any modifications to the appliance or the use of spare parts and accessories important for operation which are not original Truma parts, of non-observance of the instructions for installation and use will result in the guarantee becoming invalid and no liability will be assumed.

Furthermore the approval for operating the appliance will become invalid and in some countries also the approval for operating the vehicle.

### Technical Data

Power supply: 230 V ~, 50 Hz

Power consumption  
at power setting: 500 W: 2.2 A  
1000 W: 4.5 A  
2000 W: 8.5 A

Weight: approx 2kg

**The mains element on the space heater is designed for supplementary heating. It is not recommended to run along side the gas for prolonged periods of time.**

### TEB FAN

**Always observe the operating instructions prior to starting!**

**The vehicle owner is responsible for the correct operation of the appliance.**

**Repairs are only to be carried out by an expert!**

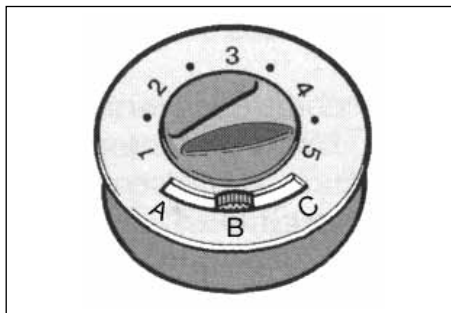

a = Manual control  
(e.g. for ventilation) Adjust desired output at the control knob.

b = Off  
(or automatic operation/ heating with heaters Trumatic S 3002 K and S 5002 K)

c = Automatic operation

(Heating) The output steadily adjusts to the respective heat emission of the heater. The maximum output can be limited at the control knob, as required. The regulating between this value and slow running is carried out automatically.

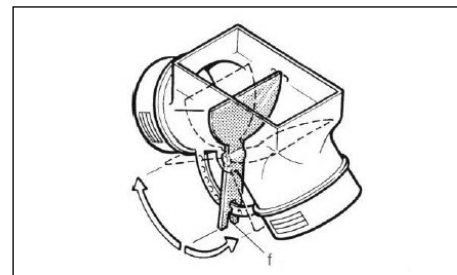

The quantity of air can be individually adjusted at the air flap (f), for warm air distribution.

In centre position 50% of the warm air is distributed to each outlet.

Use the fan duct with 72 mm and if the fan ducts are of different lengths or on sides with a greater heat requirement. This means that the air output can be used to the full on this side. By adjusting the air flap (f) the quantity of air can be increased individually. This means that the air out-put on the other side is reduced.

If the air output drops or the operating noise increases, the fan impeller wheel may be severely soiled.

## Cleaning

(with switched off appliance!) We recommend removing dust which has collected on the heat exchanger and base plate of the heater and on the impeller wheel of the Trumavent fan, once a year before the heating season starts. Clean the impeller wheel carefully using a brush or tooth brush.

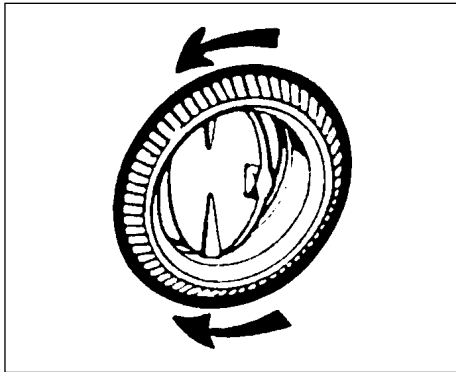

## Blown air ducts

The air ducting outlets are generally of the butterfly type and may be opened or closed to control the quantity of air by adjusting the butterfly valves. Twisting the disc in its housing directs the flow in the direction required.

For uniform distribution, outlets nearest the heater should be closed more than those further away.

One outlet on each leg of the air ducting layout must be kept open at all times.

Under no circumstances should the air ducting outlets be blocked.

## TRUMA COMBI 4 / COMBI 6

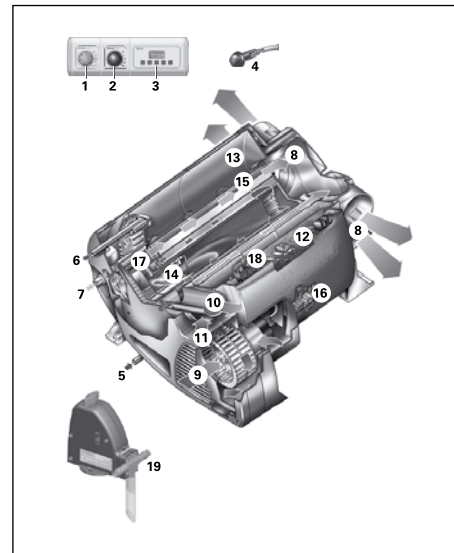

- 1 Control panel
- 2 Power selector switch
- 3 Time switch ZUCB (Accessories)
- 4 Room temperature sensor
- 5 Cold water connection
- 6 Hot water connection
- 7 Gas connection
- 8 Hot air outlets
- 9 Recirculated air intake
- 10 Waste gas discharge
- 11 Combustion air infeed
- 12 Electronic control unit
- 13 Water container (10 litres)
- 14 Burner
- 15 Heat exchanger
- 16 Power electronics
- 17 Heating elements 230 V
- 18 Overheating switch 230 V
- 19 FrostControl (safety/drain valve)

## Function description

The liquid gas heater Combi E is a warm-air heater with integrated hot water boiler (10 liter volume). The burner operates fan-supported, which ensures trouble-free function even when on the move. The unit also has heating elements for electrical operation.

In winter operation the heater can be used to heat the room and simultaneously warm water. If only warm water is required, select summer operation.

## Equipment details

At a temperature of approximately 3 °C at the automatic FrostControl safety/drain valve, the valve will open and drain the boiler.

3 different options are available for operating the unit.

- gas operation only Propane / Butane for autonomous use
- electrical operation only 230 V for stationary use on camp sites
- or gas and electrical operation – mixed operation only possible in winter mode.

### Winter operation

In winter operation, the unit automatically selects the required power setting according to the temperature difference between the temperature set on the control panel and the current room temperature. When the boiler is filled, the water is automatically heated as well. The water temperature depends on the selected operational mode and the heater output.

All 3 energy selection options can be used for winter deployment.

With gas operation the unit automatically selects the output level that is required.

Depending on the fuse protection at the camping site, power of 900 W (3.9 A) or 1800 W (7.8 A) can be manually selected for electrical operation.

If more output is required (e.g. heating up or low outside temperatures) gas or mixed operation should be selected so that enough heating power is always available.

With mixed operation, 230 V electrical operation is preferred if the power requirement is low (e.g. for maintaining the room temperature). The gas burner is not enabled until the power requirement is higher, and is the first to switch off during heat-up operations.

### Summer operation (boiler operation only)

Gas operation or 230 V electrical operation is used for hot water preparation. The water temperature can be set to 40 °C or 60 °C.

With gas operation the water is heated at the lowest burner setting. Once the water temperature is reached, the burner switches off.

Depending on the fuse protection at the camping site, power of 900 W (3.9 A) or 1800 W (7.8 A) can be manually selected for electrical operation.

Mixed operation is not possible. With this setting the unit automatically selects electrical operation. The gas burner is not enabled.

### Safety instructions

The use of upright gas cylinders from which gas is taken in the gas phase is mandatory for the operation of gas regulators, gas equipment and gas systems. Gas cylinders from which gas is

taken in the liquid phase (e. g. for fork lifts) must not be used, since they would result in damage to the gas system.

If the gas system is leaking or if there is a smell of gas:

- extinguish all open flames
- open windows and door
- close all quick-acting valves and gas cylinders
- do not smoke
- do not activate any electric switches
- ask an expert to inspect the entire system!

### Repairs may only be carried out by an expert!

Guarantee claims, warranty claims and acceptance of liability will be ruled out in the event of the following:

- modifications to the unit (including accessories),
- modifications to the exhaust duct and the cowl,
- failure to use original Truma parts as replacement parts and accessories,
- failure to follow the installation and operating instructions.

It also becomes illegal to use the appliance, and in some countries this even makes it illegal to use the vehicle.

## Equipment details

The gas supply's operating pressure (30 mbar) must be the same as the unit's operating pressure (see type plate).

Liquid gas systems must comply with the technical and administrative regulations of the respective country of use (e.g. EN 1949 for vehicles in Europe). The national legislation and regulations (e.g. DVGW Work Sheet G 607 for vehicles in Germany) must be observed.

In Germany, the gas system must be retested every 2 years by a liquid gas specialist (DVFG, TÜV, DEKRA). The test must be confirmed on the respective test certificate (G 607).

The vehicle owner is always responsible for arranging the inspection.

Liquid gas equipment may not be used when refueling, in multi-storey car parks, in garages, or on ferries.

During the initial operation of a brand new appliance (or after it has not been used for some time), a slight amount of fumes and smell may be noticed for a short while. It is a good idea to heat the device up several times in summer operation (60 °C) and to make sure that the area is well ventilated.

Heat-sensitive objects such as spray cans or flammable liquids may not be stored in the same compartment where the heater is installed because, under certain conditions, this area may be subject to elevated temperatures.

Only pressure regulating equipment that complies with EN 12864 (in vehicles) with fixed output pressure of 30 mbar may be used for the gas system. The flow rate of the pressure control device must correspond to at least the maximum consumption of all devices installed by the system manufacturer.

For vehicles, we recommend Truma's SecuMotion gas pressure regulator; for the two-cylinder gas system we also recommend the Truma DuoComfort changeover valve.

At temperatures of around 0 °C or less the gas pressure regulator and the changeover valve should be operated using the EisEx regulator heater.

Controller connecting hoses that meet national regulations must always be used in the respective country for which the equipment is destined. These hoses must be checked regularly for brittleness. Winter-proof special hoses must always be used if the equipment is operated during the winter.

Pressure regulating equipment and hoses must be replaced with new ones no more than 10 years after the date of manufacture (every 8 years if used commercially). This is the responsibility of the operator.

### **Important operating notes**

If the cowl has been placed near or directly beneath an opening window, the device must

be equipped with an automatic shut-off device in order to prevent operation with the window open.

The integrity and tight fit of the exhaust gas double duct must be checked regularly, particularly at the end of long trips. Also check the mounting of the appliance and the cowl.

Following a blow-back (misfire) always have the exhaust gas system checked by an expert!

Always keep the cowl for the exhaust duct and combustion air intake free of contamination (slush, ice, leaves etc.).

The hot air outlets and the recirculated air intake openings must be free so that the unit does not overheat. The integrated temperature limiter blocks the gas supply when the unit becomes too hot.

Directive 2004/78/EC stipulates that a safety shut-off device is required if motor homes are being heated while driving.

The Truma SecuMotion gas pressure regulator meets this requirement.

If no safety shut-off device is installed (e.g. the Truma SecuMotion gas pressure regulator), the gas cylinder must be closed while driving and information signs must be attached to the gas cylinder protection box and in the vicinity of the control panel.

## Equipment details

The safety shut-off device is also recommended for safety reasons if caravans are being heated while driving.

### Operating Instructions

Always observe the operating instructions and “Important operating notes” prior to starting! The vehicle owner is responsible for the correct operation of the appliance.

The installer or vehicle owner must apply the yellow sticker with the warning information, which is enclosed with the appliance, to a place in the vehicle where it is clearly visible to all users (e.g. on the wardrobe door)! Ask Truma to send you stickers, if necessary.

Before using for the first time, it is essential to flush the entire water supply system through with clean water. If the heater is not being used, always drain the water contents if there is a risk of frost. There shall be no claims under guarantee for damage caused by frost!

### Power selector switch

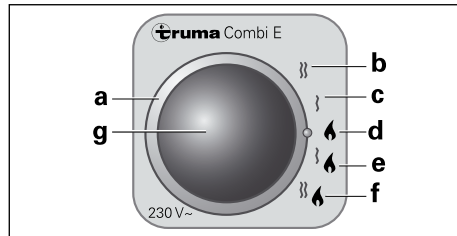

a = Power selection rotary switch

b = Electric operation 230 V, 1800 W

c = Electric operation 230 V, 900 W

d = Gas operation

e = Mixed operation\* (900 W gas and electrical operation)

f = Mixed operation\* (1800 W gas and electrical operation)

g = Yellow LED on = “Electrical operation”

\* Winter mode only!

In summer mode the unit automatically selects electric operation at the preselected electrical power of 900 W or 1800 W.

**Switching on the electric heating elements as well does not increase the maximum heating power.**

### Control panel

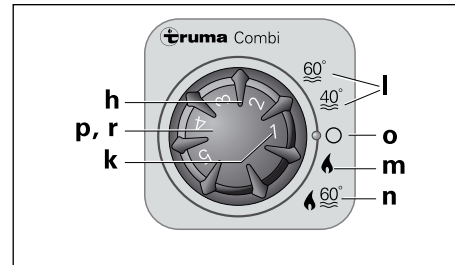

h = Rotary switch for room temperature (1 – 5)

k = green LED lit “Operation” green LED blinking “after-running” is active in order to reduce the unit’s temperature

l = Summer operation (water temperature 40 °C or 60 °C)

m = Winter operation (heating without water temperature monitoring or with drained water system)

n = Winter operation (heating with water temperature monitoring)

o = Rotary “Off” switch

p = yellow LED lit “Boiler heat-up phase”

r = red LED lit, red LED blinking “Failure”

**The LEDs are visible only when the unit is switched on.**

### Room thermostat

To measure the room temperature, an external room temperature sensor (s) is located in the vehicle. The location of the sensor is determined individually by the vehicle manufacturer, depending on the vehicle type; consult the operating instructions for your vehicle for further details.

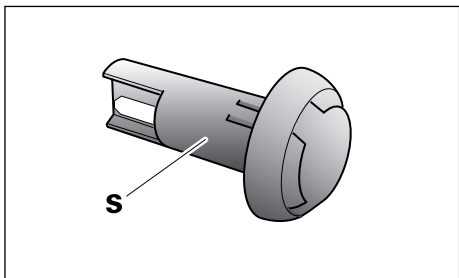

s = Room temperature sensor

The thermostat setting on the control panel (1 – 5) must be determined individually depending on the heating requirement and the type of vehicle. For an average room temperature of about 23 °C, we recommend a thermostat setting of about 4.

### FrostControl (safety/drain valve)

FrostControl is a currentless safety/drain valve. When there is a danger of frost, it automatically drains the contents of the boiler through a drainage muff. If excessive pressure is present in the system, pressure will be automatically intermittently equalized through the pressure relief valve.

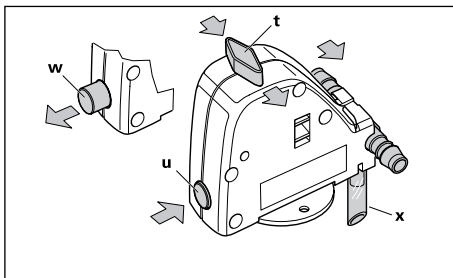

t = rotary switch position “Operation”

u = push button position “Closed”

w = push button position “Drain”

x = drainage muff (led outside through floor of vehicle)

### Closing the drain valve

Check if the rotary switch is set to “Operation” (position t), meaning that it is parallel to the water connection and engaged.

Close the drain valve by activating the push button. The push button must engage in position (u) “closed”.

Only when the temperature around the drain valve is over around 7 °C can it be closed manually with the press button (“u” position) and the boiler filled. Truma supplies a heating element (part no. 70070-01) as an accessory, which is inserted into the FrostControl and fixed in place with a retaining bracket. This heating

element heats the FrostControl to approx. 10 °C when the Combi is switched on. This means that the boiler can be filled after a shorter time, irrespective of the temperature in the installation compartment.

### Automatic opening of the drain valve

If the temperature around the drain valve is below about 3 °C, it will open automatically and the push button will disengage (outward movement) (“w” position). The water from the boiler will be released through the drainage muff (x).

### Manual opening of the drain valve

Turn the rotary switch by 180° until it engages, whereby the push button moves out (position w). The water in the boiler drains out through the drainage muff (x).

The FrostControl drainage muff (x) must be free of contamination (slush, ice, leaves, etc.) at all times so the water can drain out easily! There shall be no claims under guarantee for damage caused by frost!

### Taking into operation

Heating is possible without restrictions with gas, electrical and mixed operation, with or without water.

Check to make sure the cowl is unobstructed. Be sure to remove any covers that may be present.

## Equipment details

Turn on gas cylinder and open quick-acting valve in the gas supply line.

Check whether the power supply fuse protection on the camp site is adequate for the 900 W (3.9 A) or 1800 W (7.8 A) that have been selected using the power selector switch.

The cable drum must be fully unwound in order to prevent the power cable from overheating.

### **Summer operation (boiler operation only)**

Select gas or electrical operation using the power selector switch. Illumination of the yellow LED (g) on the power selector switch indicates that the unit is operating with 230 V.

Mixed operation (gas and electrical) is not possible in summer mode. With this setting the unit automatically selects electrical operation with a preselected power setting of 900 W or 1800 W.

Move the rotary switch on the control panel to position (l – summer operation) 40 °C or 60 °C. The green (k) and yellow (p) LEDs light up.

When the selected water temperature is reached (40 °C or 60 °C) the heater shuts off and the yellow LED (p) goes off.

### **Winter operation**

- Heating with water temperature monitoring

Select gas, electrical or mixed operation using the power switch. Illumination of the yellow LED (g) on the power selector switch indicates that the unit is operating with 230 V.

Move rotary switch on control panel to operating position (n).

Set the rotary switch (h) to the desired thermostat setting (1 – 5). The green LED (k) for operation is lit and simultaneously indicates the position of the selected room temperature. The yellow LED (p) indicates the water's heat-up phase.

The device automatically selects the required power setting in accordance with the temperature difference between the temperature selected on the control panel and the current room temperature. When the room temperature selected on the control panel is reached, the heater switches back to the smallest setting and heats the water to 60 °C. Once the water temperature is reached, the heater switches off and the yellow LED (p) goes out.

The warm air fan can continue to run in order to cool the unit (after-run).

- Heating without water temperature monitoring

Select gas, electrical or mixed operation using the power switch. Illumination of the yellow LED (g) on the power selector switch indicates that the unit is operating with 230 V.

Move rotary switch on control panel to operating position (m).

Turn the rotary switch (h) to the desired thermostat setting (1 – 5). The green LED (k) for operation is lit and simultaneously indicates the position of the selected room temperature. The yellow LED (p – water's heat-up phase) will be lit only when the water temperature is below 5 °C!

The device automatically selects the required power setting in accordance with the temperature difference between the temperature selected on the control panel and the current room temperature. Once the room temperature selected on the control panel has been reached, the heater switches off. The warm air fan continues to run at slow speed until the outgoing air temperature (on the unit) has fallen to 40 °C or less.



If the boiler is filled, the water will automatically be heated at the same time. The water temperature is then dependent on the heating output being given off, and the duration of heating required to reach the desired room temperature.

### – Heating with drained water system

Select gas or electrical operation using the power selector switch. Illumination of the yellow LED (g) on the power selector switch indicates that the unit is operating with 230 V.

Move rotary switch on control panel to operating position (m).

Turn the rotary switch (h) to the desired thermostat setting (1 – 5). The green LED (k) for operation is lit and simultaneously indicates the position of the selected room temperature. The yellow LED (p) will be lit only when the temperature of the unit is below 5 °C!

Depending on the operating mode, the unit will automatically select the required power level according to the temperature difference between the setting on the control panel and the current room temperature. Once the room temperature selected on the control panel has been reached, the heater switches off. The warm air fan continues to run at slow speed until the outgoing air temperature (on the unit) has fallen to 40 °C or less.

### Switching off

Switch off heater at control panel using rotary switch (position o). The green LED (k) goes off.

If the green LED (k) blinks after switching off, then the unit's after-running is active in order to reduce the unit's temperature. This will end after a few minutes and the green LED (k) will go off.

Always drain water contents if there is a risk of frost! If the appliance is not to be used for a prolonged period, close the quick-acting valve in the gas supply line and turn off the gas cylinder.

### Gas operation fault

If a fault occurs during gas operation the red LED (r) on the control panel illuminates.

Please consult the Trouble-Shooting list for possible causes.

A reset (fault reset) is carried out by switching off, waiting until all LED's on the control panel have stopped flashing, and then switching the heater on again.

If a window to which a window switch has been fitted is opened, the heater stops operating and the red LED (r) flashes. The heater continues operating when the window is closed.

### Electrical operation fault

If a fault occurs during electrical operation the yellow indicator lamp (g) on the power selector switch goes off.

Possible causes can be found in the troubleshooting list.

If the 230 V power supply is interrupted for just a brief period of approximately 1 second during operation, the heater will subsequently resume as normal.

### Filling the water heater

Check if the rotary switch for the drain valve (FrostControl) is set to "Operation", meaning that it is parallel to the water connection and engaged.

Close the drain valve by pushing the push button until it engages.

When the temperature at FrostControl is below about 7 °C, first switch on the heater to warm the installation compartment and FrostControl. After several minutes, when the temperature at FrostControl is above 7 °C, the drain valve can be closed.

Switch on power for water pump (main or pump switch).

Open hot water taps in kitchen and bathroom, (set preselecting mixing taps or single-lever fittings to "hot"). Leave the fittings open for as long as it takes for the boiler to displace the air and fill up, and the water to flow without interruption.

## Equipment details

If just the cold water system is being operated, without using the water heater, the heater tank also fills up with water. To avoid frost damage, the boiler must be drained through the drain valve, even if it was not operated.

When connecting to a central water supply (rural or city mains), a pressure reduction valve must always be installed to prevent pressures above 2.8 bar from developing in the water heater.

### Draining the water heater

Switch off power to water pump (main or pump switch).

Open hot water taps in kitchen and bathroom.

In order to check the water that is flowing out, place an appropriate container (capacity 10 litres) beneath the drain valve (FrostControl) drainage muff (x).

Turn the rotary switch on the drain valve by 180° until it engages, whereby the push button moves out and the drain valve opens.

Check whether all of the water in the boiler (10 litres) has been drained into the container via the drain valve.

**There shall be no claims under guarantee for damage caused by frost!**

### Maintenance

Only original Truma parts may be used for maintenance and repair work! Materials in the device which come into contact with water are suitable for use with drinking water (see manufacturer's declaration: [www.truma.com / downloads / manufacturer's declaration](http://www.truma.com/downloads/)).

Bio-film, deposits and limescale must be removed using chemicals to protect the unit from infestation by microorganisms.

Only chloride-free products must be used in order to prevent damage to the unit.

The effectiveness of the use of chemicals to combat microorganisms in the unit can be increased by heating the water in the boiler to 70 °C at regular intervals.

Move power selector switch to gas operation (d) to do this.

Move the rotary switch on the control panel to position (l – summer operation) 60 °C. The green (k) and yellow (p) LEDs light up.

Once the water in the boiler has reached a temperature of 60 °C, the burner will switch off and the yellow LED (p) will go out. The unit must stay switched on for at least 30 minutes and no warm water may be removed. The residual heat in the heat exchanger will heat the water up to 70 °C.

### Fuses 12 V

The fuse is in the electronics beneath the connection cover.

Replace the unit's fuse only with an identical fuse.

Device fuse: 10 A – slow – (T 10 A)

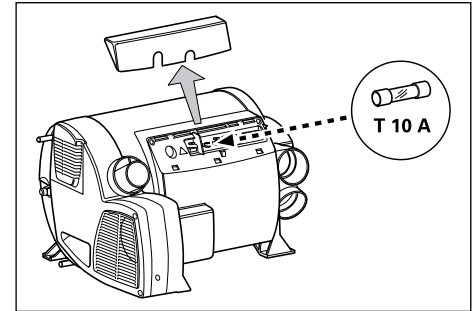

### Fuses 230 V

The fuse and the power supply lines must only be replaced by an expert!

The unit must be disconnected from the mains (all poles) before opening the electronic housing lid.

The fuse is in the power electronics (16) beneath the electronic housing lid.

This fine fuse must always be replaced with a fuse of the same type: 10 A, slow, interrupting capacity "H".

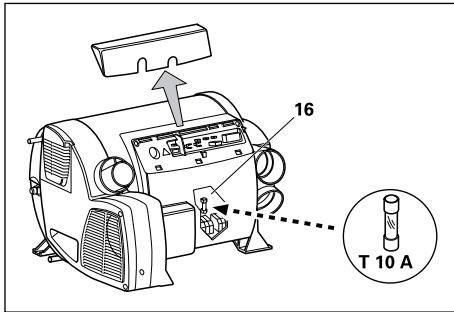

### Overheating protection 230 V

The 230 V heating facility has a mechanical overheating switch. If the 12 V power supply is interrupted during operation or during the after-run period, for example, the temperatures within the unit could activate the overheating protection.

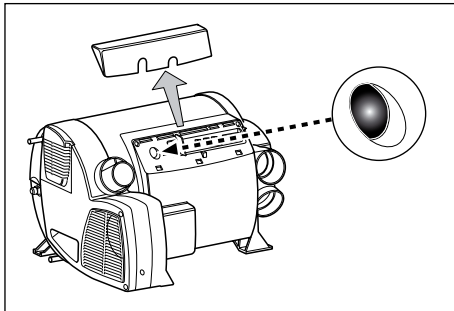

To reset the overheating protection, allow heater to cool, remove connection cover and press red reset button.

### Disposal

The liquid gas heater must be disposed in accordance with the administrative stipulations of the respective country in which it is used. National regulations and laws (in Germany, for example, the Altfahrzeug-Verordnung – old vehicle directive →) must be observed.

In other countries, the relevant regulations must be observed.

### Technical data

determined in accordance with EN 624 or Truma test

### Device category

$\frac{1}{3}$  B/P in accordance with EN 437

**Type of gas:** Liquid gas (propane / butane)

**Operating pressure:** 30 mbar (see type plate)

**Water contents:** 10 litres

**Heating up time from approx. 15° C to approx. 60° C**

Boiler approx. 20 minutes (measured according to EN 15033) Heater + boiler approx. 80 min.

**Water pressure:** max. 2.8 bar

**Rated thermal output (automatic output levels)**

Combi 4 E: 2000 W / 4000 W

Combi 6 E: 2000 W / 4000 W / 6000 W

Electrical operation

Combi 4 E / Combi 6 E: 900 W / 1800 W

Mixed operation (gas and electrical)

Combi 4 E: max. 3800 W

Combi 6 E: max. 5800 W

### Gas consumption

Combi 4 E: 160 – 320 g/h

Combi 6 E: 160 – 480 g/h

Readiness-heat power requirement

Combi 4 E / Combi 6 E:

Gas operation 5.2 g/h

### Air delivery volume (free-blowing without hot-air pipe)

Combi 4 E: with 3 hot-air outlets max. 249 m³/h

with 4 hot-air outlets max. 287 m³/h

Combi 6 E: with 4 hot-air outlets max. 287 m³/h

### Current input at 12 V

Combi 4 E: Short-term max. 5.6 A

(average power consumption 1.1 A)

Combi 6 E: Short-term max. 5.6 A

(average power consumption 1.3 A)

Heating up of boiler: 0.4 A

Stand-by: 0.001 A

Heating element FrostControl (optional):

maximum 0.4 A

### Current input of 230 V

3.9 A (900 W) or 7.8 A (1800 W)

## Equipment details

### **Weight (not containing water)**

Heater unit: 15.1 kg

Heater unit with peripheral devices: 15.6 kg

### **Declaration of conformity**

The Truma Combi E has been tested by the DVGW and complies with the gas equipment directive (90/396/EEC) and the other applicable EC directives. The following CE Product Ident. No. is available for EU countries

Combi 4 E / Combi 6 E: CE-0085BS0085

The heater complies with heater directive 2001/56/EC and supplements 2004/78/EC and 2006/119/EC and bears the type approval number

Combi 4 E: e1 00 0193

Combi 6 E: e1 00 0194

The heater complies with the interference suppression directive 72/245/EEC for vehicle engines with annexes 2004/104/EC, 2005/83/EC and 2006/28/EC and bears type approval number: e1 03 5020

The heater complies with EMC directive 89/336/EEC and low voltage directive 73/23/EEC.

## Troubleshooting

Fault	Cause	Rectification
After switching on (winter and summer operation) none of the LEDs are lit.	<ul style="list-style-type: none"> <li>- No operating voltage.</li> <li>- Device fuse or vehicle fuse defective.</li> </ul>	<ul style="list-style-type: none"> <li>- Check 12 V battery voltage, charge if necessary.</li> <li>- Check all electrical plug connections.</li> <li>- Check the unit or vehicle fuse and replace if necessary (see fuses).</li> </ul>
The green LED comes on when the unit is switched on, but the heater does not operate.	- The temperature setting on the control panel is lower than the room temperature.	- Select higher room temperature at the control panel.
The green LED comes on when the unit is switched on (by means of the ZUCB time switch), but the heater does not operate.	<ul style="list-style-type: none"> <li>- Open window above cowl (window switch).</li> <li>- Battery voltage is too low &lt; 10.5 V.</li> </ul>	<ul style="list-style-type: none"> <li>- Close window.</li> <li>- Charge battery.</li> </ul>
After the heater is switched on, the green LED is lit and the red LED blinks.	- Electronics are defective.	- Please contact the Truma Service Centre.
Approximately 30 seconds after the heater is switched on, the red LED is lit.	<ul style="list-style-type: none"> <li>- Gas cylinder or quick-closure valve in the gas line is closed.</li> <li>- Combustion air infeed or exhaust outlet is sealed.</li> </ul>	<ul style="list-style-type: none"> <li>- Check gas supply and open valves.</li> <li>- Inspect openings for contamination (slush, ice, leaves, etc.) and remove contamination if necessary.</li> </ul>
After operating for a longer period of time, the heater switches to failure.	<ul style="list-style-type: none"> <li>- Summer operation with empty water tank.</li> <li>- Hot-air outlets blocked.</li> <li>- Recirculated air intake blocked.</li> <li>- Gas pressure regulator iced up</li> <li>- Butane content in the gas cylinder too high.</li> </ul>	<ul style="list-style-type: none"> <li>- Switch device off and allow to cool. Fill boiler with water.</li> <li>- Check individual outlet apertures.</li> <li>- Remove blockage from recirculated air intake.</li> <li>- Use regulator heating (EisEx).</li> <li>- Use propane (at temperatures below 10 °C in particular, butane is unsuitable for heating purposes).</li> </ul>

## Equipment details

Green and red LEDs blink after heater is switched off.	<ul style="list-style-type: none"> <li>- Unit was switched off during failure. After-running is active in order to reduce the unit's temperature.</li> </ul>	<ul style="list-style-type: none"> <li>- After-running will switch off after a few minutes. Only at that time will a failure reset be possible (switch off and then back on).</li> </ul>
Green LED blinks after heater is switched off.	<ul style="list-style-type: none"> <li>- After-running is active in order to reduce the unit's temperature.</li> </ul>	<ul style="list-style-type: none"> <li>- No failure. After-running will switch off after approximately 5 minutes.</li> </ul>
When the device is switched on in electrical operation the red LED on the control panel flashes, the yellow LED on the power selector switch does not illuminate and the heater does not heat up.	<ul style="list-style-type: none"> <li>- No 230 V operating voltage.</li> <li>- 230 V fuse defective.</li> <li>- Overheating protection has activated.</li> </ul>	<ul style="list-style-type: none"> <li>- Check 230 V operating voltage.</li> <li>- Check 230 V fuse and replace if necessary.</li> <li>- Reset overheating protection. Allow heater to cool, remove connection cover and press reset button.</li> </ul>
<b>Water Supply</b>		
After the heater is switched off, the drain valve opens (FrostControl).	<ul style="list-style-type: none"> <li>- Temperature at drain valve is below 3°C</li> </ul>	<ul style="list-style-type: none"> <li>- Switch the heater on. If the temperature is below approximately 3°C, the drain valve will open automatically! If the heater is not in operation, the drain valve can be reclosed only when the temperature is approximately 7°C or higher!</li> <li>- Use heating element for FrostControl.</li> </ul>
The drain valve (FrostControl) can no longer be closed.	<ul style="list-style-type: none"> <li>- Temperature at drain valve is below approximately 7° C.</li> <li>- Rotary switch is not at 'Operation'.</li> </ul>	<ul style="list-style-type: none"> <li>- Switch the heater on. If the heater is not in operation, the drain valve can be reclosed only when the temperature is approximately 7°C or higher!</li> <li>- Turn the drain valve's rotary switch to 'Operation', then press the push button until it engages.</li> </ul>
Water flows intermittently from the FrostControl drain muff.	<ul style="list-style-type: none"> <li>- Water pressure too high.</li> </ul>	<ul style="list-style-type: none"> <li>- Check pump pressure (max. 2.8 bar). If connected to a central water supply (rural or urban connection), a pressure reducer must be used, which will prevent pressures higher than 2.8 bar entering the boiler.</li> </ul>

**If these measures do not remove the failure, please contact the Truma Service Centre.**

## ALDE COMPACT 3010 QUICK START GUIDE

Use the Left < and Right > arrow keys to move across the symbols. Highlight the required symbol so that it flashes. You can then adjust the function.

Use the +/On and -/Off keys to adjust settings and turn functions On and Off.

**On** With 'On' displayed the boiler is in standby mode and ready to be given commands.

**Off** With 'Off' displayed the boiler is shutdown.



Select your desired room temperature.



30 min hot water booster, with this function 'On' the circulation pump for the heating is turned off.



Select 'On' to operate the boiler LPG.



Select 1kW or 2kW to operate the boiler on 230V Electric.



Indicates that the circulation pump is operating for central heating.



Indicates that 230V is supplied to the boiler.

## PRE-START CHECKS

- Ensure the system is filled with Glycol before starting the boiler, check the expansion tank level. The fluid should be 10mm above the minimum mark when cold.
- Ensure adequate LPG Propane, 230V and 12V supplies are connected and turned on. The control panel should be active and display the 230V connection symbol.
- Turn the boiler 'On' using the control panel, then scroll across and raise the desired room temperature to +30°C. The circulation pump symbol should appear. Visually check in the expansion tank that the pump is operating.
- Scroll across and turn on the 2kW electric heater using the panel. Wait for 10 minutes and check that the upper flow pipe on the boiler is getting hot. The bottom return pipe may also be warm.
- Scroll back and turn on the gas burner using the control panel. You might not be able to hear it start, so visually check the flue outside to confirm the boiler is operating. Wait for 10 minutes and check the lower return pipe on the boiler. It should now be hot and the boiler fully operational.



## Equipment details

### ALDE COMPACT 3010



**Please read these instructions carefully before using the boiler.**

These instructions are approved for The Alde Compact 3010 boiler fitted in caravans, motor caravans and buildings in accordance with CE no. EMC e5 02 0138, 845 BP-0003.

Installation and repairs may only be carried out by a professional. National regulations must be adhered to.

#### **BOILER DESIGN**

The boiler consists of three eccentrically- fitted cylinders (heat exchanger, water jacket for the heating system and, outermost, water jacket for hot water). The two outer pipes, and their ends and connections, are made of stainless steel, while the heat exchanger is made of aluminium.

The heat exchanger is divided into two semi-circles. The burner is located in the upper

half, being the combustion chamber, and the combustion gases are expelled through the lower half. The burner unit is fitted on the end of the heat exchanger. It consists of a combustion fan, burner, solenoid valve and intake/exhaust connections. Two heating cartridges are fitted to the water jacket of the heating system. Maximum output is 2 or 3 kW, depending on model.

#### **DESCRIPTION OF FUNCTIONS**

##### **Using LPG**

When LPG operation is selected on the control panel, the combustion fan starts. When the fan speed is correct, it signals the circuit board that the boiler can be lit. The circuit board sends ignition sparks to the sparkplug at the same time as it sends electricity to the solenoid valve, which opens to allow gas in. The burner ignites, and a sensor transmits a signal back to the circuit board that the boiler is lit, and the ignition spark stops. The burner keeps burning until the boiler thermostat or the room thermostat reaches the set temperature reading.

Should the boiler go out for any reason, the sensor is activated and a new attempt is made to start the boiler (in about 10 seconds).

##### **Using the heating cartridge**

Electrical operation is selected on the control panel, the 12-volt relays on the circuit board

trip, allowing the 230 volt supply to reach the electrical elements.

The heating cartridge is controlled in the same way as the gas boiler.

##### **Warm water**

When only warm water is required, for example during the summer, no settings need to be made, the boiler will look after this function automatically.

The pump will only start when the temperature in the vehicle is lower than the set temperature (see item 4, Control Panel). If the vehicle temperature is higher, the pump will not start.

#### **IMPORTANT INFORMATION**

- The boiler must not be started if there is no glycol in the system.
- The LPG boiler and heating cartridge may be operated in parallel.
- The heating system may be heated up without the warm water heater being filled with fresh water.
- Always switch off the main isolator for the boiler when the vehicle is not being used.
- Always drain the warm water heater of fresh water if there is a risk of frost.
- The LPG boiler must not be operated when refuelling the vehicle.



- When washing the vehicle, take care not to get water in the venting.

### The Domestic hot water heater

The boiler is fitted with a built-in warm water heater with a volume of approx. 8.5-litres fresh water. The warm water heater can produce around 12 litres of 40°C water per half-hour (at a cold water temperature of 10°C). If the heating cartridges are used instead of gas for heating the boiler, the capacity is slightly reduced.

Always rinse out the heater before it is used, particularly if it has not been in operation for some time. **NB!** The hot water is not intended for drinking or cooking. When the heater is in continuous use, it should be emptied approx. once a month, to ensure that a new air cushion is formed in the heater.

The air cushion is essential for absorbing pressure surges in the heater. For emptying specially-adapted boilers, as well as any other freshwater systems in the vehicle, please refer to the manufacturer's instructions.

**NB! The warm water heater should always be drained of fresh water when there is a risk of frost and when the caravan is not in use.**

The warranty does not cover frost damage.

### Draining the heater using the combined safety/drain valve:

1. Switch off the freshwater pump
2. Open all water taps.
3. Then open the safety/drain valve by raising the yellow lever (M) to a vertical position.
4. The heater will now drain directly below the vehicle through the safety/drain valve hose. Check that all the water is emptied out (about 7-10 litres). Leave the valve in the open position until the next time the heater is used.

**NB!** Check that the automatic check valve (N) is open and is allowing air to enter the heater when it is being drained, and that the hose (O) is not blocked.

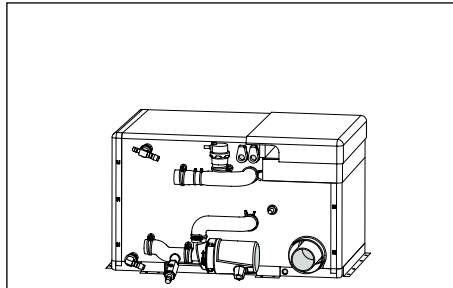

### THE HEATING CARTRIDGES

All Compact 3010s are fitted with two 230V heating cartridges with a maximum output of either 2100 or 3150W. Select the heating cartridge output on the control panel.

Always check that the input fuse of the vehicle has the correct amperage in relation to the selected output.

Note these ratings are for the boiler only.

1050W requires a 6 amp fuse.  
2100W requires a 10 amp fuse.  
3150W requires a 16 amp fuse

### THE CIRCULATION PUMP

A circulation pump is required to circulate the heated glycol fluid. A 12V circulation pump is fitted in the expansion tank.

An optional 230V circulation pump can be fitted on the boiler. Selection of circulation pump is made with a switch on the control panel. The room thermostat on the control panel controls the circulation pump, i.e. switches it on or off according to the amount of heat required.

### SYSTEM TEMPERATURE

The boiler is set to a system temperature of 80°C, i.e. the temperature of the glycol fluid as it circulates in the heating system.

## Equipment details

### AIR CIRCULATION

In order to achieve the best possible result from the principle of convected heat, it is important to allow air to circulate freely under bunks, and behind backrests and wall-mounted cabinets.

If the vehicle has a fitted carpet, ensure that the carpet does not obstruct the air supply to the radiators.

It is just as important that cushions or blankets do not interrupt the flow of air behind backrests and wall cabinets.

### MAINTAINING THE HEATING SYSTEM

#### WINTERCAMPING

While camping during the winter, ensure that the flue is kept clear of snow and ice, since the inlet air to the LPG boiler enters through the flue. Do not start the LPG boiler until the flue is completely free of snow. A flue extension (part no. 3000 320) for fitting on the roof is recommended for winter camping.

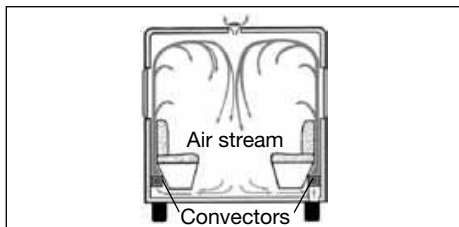

### THE LPG SYSTEM

The LPG system should be checked regularly by a professional, who will ensure that there are no leaks from connections or hoses.

LPG hoses should be changed according to national regulations, maximum of five years. Check the date stamp on the hose. Hose has a propensity to dry out and crack.

To increase safety, we recommend fitting an Alde leak gauge, type 4071, as close as possible to the pressure reduction valve.

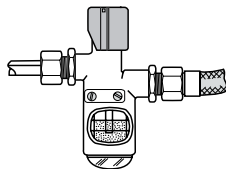

### THE HEATING SYSTEM

Regularly check the heating system's fluid level in the expansion tank. The level should be about 1cm above the minimum indicator in a cold tank. The heating system should be filled with a mixture of water and glycol.

For preference, use high quality readymixed glycol (with inhibitor) intended for use in aluminium heating systems.

If using concentrated glycol, the mixture should consist of 60% water and 40% glycol. If the

heating system will be exposed to temperatures below  $-25^{\circ}\text{C}$ , the glycol content must be increased, but not to more than 50%. Any vessels used for the liquid must be spotlessly clean, and the pipes in the heating system must be free of contamination. This will prevent the growth of bacteria in the system.

The glycol mixture should be changed every second year, since its ability to protect against corrosion, for example, will deteriorate. The glycol content should be checked before topping up with new liquid. This will ensure that the concentration of glycol in the mixture is not too high.

If the fluid level in the expansion tank falls for reasons other than evaporation, please check all joints, drain cocks and bleeder screws to ensure that they are not leaking. If the glycol-water mixture leaks out, rinse with water and wipe up.

Never allow the heating system to stand empty of glycol.

### FILLING THE SYSTEM WITH GLYCOL FLUID

**NB!** Any vessels used to carry the fluid must be spotlessly clean and the pipes in the system must be free of contamination. This will prevent the growth of bacteria in the system.

The system is filled through the expansion tank, either manually or using the Alde filling pump

which both tops up and bleeds the system. For manual filling, unfasten the circulation pump nut (R) and lift the pump (S) out of the tank. Slowly pour the glycol mixture into the tank. Bleed the system.

Top up with more liquid if the level has fallen after bleeding. Bleed a newlyfilled system regularly during the first days the heating system is in operation.

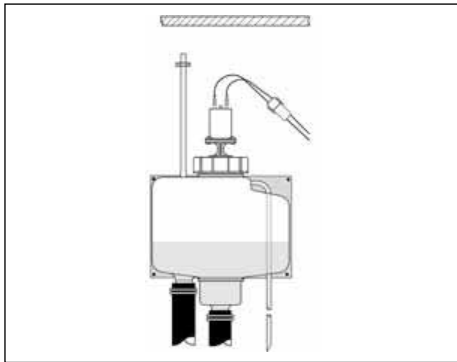

### BLEEDING THE SYSTEM

Depending on how the pipes have been fitted, air pockets may form when the system is filled with glycol fluid.

A sign that there is air trapped in the system is that the heat released into the pipes only extends a metre or so from the boiler even

though the circulation pump is operating.

In newly-filled systems, small air bubbles can form in the expansion tank, creating a murmuring sound. If the circulation pump is stopped for a few seconds, the bubbles will disappear.

### Bleeding:

If a bleeder screw is fitted to the outgoing pipe, open this bleeder screw and leave it open until it starts to discharge water.

If the boiler is fitted with an automatic bleeder, there is no need to bleed it manually. Start the LPG boiler. The circulation pump should be switched off.

Open the remaining bleeder screws in the system (please refer to the instruction manual of the vehicle for their locations). Leave the bleeder screws open until they start discharging fluid, and then close them. Start the circulation pump and let it run for a while. Check that the pipes and radiators around the vehicle are heating up.

### If they still fail to heat up, try the following:

**Single-axle caravan:** Stop the circulation pump. Lower the front of the caravan as far as possible. Leave it in this position for a few minutes to allow the air to travel upwards in the system. Open the bleeder screw at the highest point. Leave it open until it discharges glycol fluid. Raise the front of the caravan as

far as possible and repeat the procedure in this position.

Then position the caravan horizontally and start the circulation pump. Check that the pipes and radiators around the vehicle are heating up.

### Twin-axle caravan:

The easiest way to bleed the heating system is to place the vehicle on a sloping surface or to raise one end of the vehicle using a jack. Bleed the system as described above.

## ABOUT LPG

### THE PROPERTIES OF LPG

LPG is a petroleum product, formally known as “liquid petroleum gas”. It is mainly made up of propane and butane gas. The advantage of propane is that it remains gaseous at temperatures as low as  $-40^{\circ}\text{C}$ , while butane loses effectiveness at  $+10^{\circ}\text{C}$ . For this reason, propane is used in colder countries.

The cylinders contain LPG both in liquid and gaseous form. When the cylinders are filled, the pressure turns the gas into liquid. When the cylinder valve is opened, the LPG becomes a gas again. The risk involved in using LPG is that any leaking gas may ignite and explode. Since LPG is heavier than air, any leaking gas will collect at the lowest point.

LPG contains no toxic substances, but breathing in concentrated gas may have a

## Equipment details

certain anaesthetising effect, and can also result in shortness of breath and symptoms of suffocation.

These symptoms quickly disappear if the sufferer breathes in ordinary air or oxygen.

Naturally, it is inadvisable to inhale either LPG or exhaust fumes. To make it easier to detect gas leaks, a substance with a distinctly rank smell has been added.

### COMBUSTION

Complete combustion of LPG only generates carbon dioxide (CO<sub>2</sub>) and water vapour, just like the air we exhale.

A good supply of air is essential to ensure complete combustion. The flame should burn with a weak blue colour, the centre of the flame should be blue/green. LPG is extremely environmentally compatible and does not generate any soot during complete combustion. It can be stored in cylinders for an unlimited time period, without any deterioration of quality.

### PRESSURE

The LPG burner usually works at a lower pressure than that in the cylinder. Low pressure (0-50 mbar) and intermediate pressure (50 mbar- 2.0 bar) are created by allowing the gas to pass through a reduction valve. High pressure (over 2.0 bar), is unreduced pressure mainly used in camping equipment. Low

pressure and intermediate pressure are always reduced pressure.

### FAULT FINDING

#### THE BOILER DOES NOT START

1. No LPG? Incorrect type for conditions?
2. Is the main tap fully open?
3. If the boiler has not been operated for some time, or if the gas cylinder has been changed, it may take longer than normal to light the boiler.
4. Check that the boiler is connected to the electricity supply (> 11V).
5. Check that the fuse (T) for the boiler is intact.
6. Check whether the electric connections on the boiler are securely in position.

If none of the above helps, contact a service workshop.

#### THE HEATING CARTRIDGE IS NOT WORKING

1. Check that there is an electricity supply (230V ~) to the heating cartridge.
2. Check that the relays fitted to the boiler come on (a slight click can be heard from the relays when the heating cartridge is switched on at the control panel).

If none of the above helps, contact a service workshop.

### WARRANTY

Alde's warranty is valid for 3 years from the date of purchase of the caravan.

It covers material defects or manufacturing faults on the Alde heating system.

It does not cover frost damage, normal wear and tear parts, Antifreeze,

batteries or other consumables. If you have a problem please contact your dealer

or Alde UK direct.

**NB!** Only genuine Alde parts should be used as replacement parts.

## CONTROL PANEL – FUNCTIONS AND SYMBOLS

(Applies to control panels with program version 38 (06-17) or later, see item 17)

### 0. The standby and on-position of the control panel

In standby, the functions which are activated in the boiler are shown, and there is no background lighting in the display. The control panel automatically goes to standby from the on position after two minutes if no buttons are pushed or if you step to standby (left of On/Off) with the arrow keys.

Start the on position by pressing any button. The background lighting comes on (blue light) and a function that can be set flashes. Select a function that can be set with the arrow keys. The settings are automatically saved.

1. The control panel is on standby and the heater is switched off.

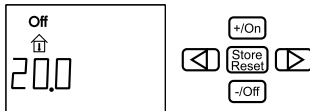

2. The control panel is on standby and the heater is operating.

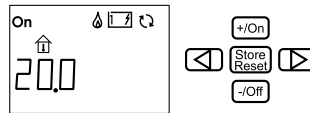

### 1. RESETTING THE SYSTEM

1. Press the Store/Reset button for 10 seconds. The control panel is reset to the factory setting.

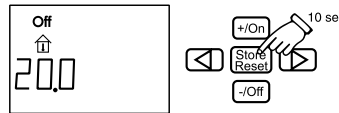

2. The main breaker to the control panel is in the "Off" position, Gas is on, Electricity at 1kW and 22°C.

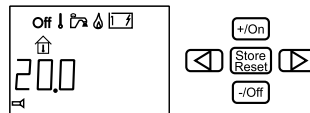

The pump is in automatic position. The lower menu row is not lit up.

### 2. START THE HEATER

Start the heating in the caravan with the settings last used.

If you break the power to the heater, the settings which were last used will automatically be used when the power comes back on.

1. Press the button with the arrow until "Off" (main breaker) in the display flashes.

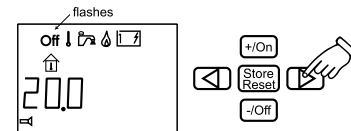

2. Press the +/On button. "On" (main breaker) in the display flashes.

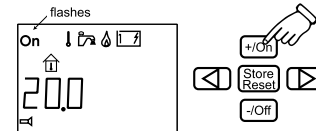

3. The settings are ready. "On" (main breaker) is shown in the display when the panel returns to standby.

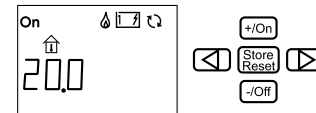

# Equipment details

## 3. SWITCH OFF THE HEATER

1. Press the button with the arrow until "On" (main breaker) in the display flashes.

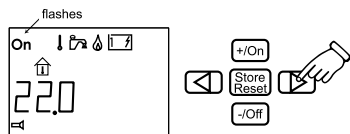

2. Press the -/Off button. "Off" (main breaker) in the display flashes.

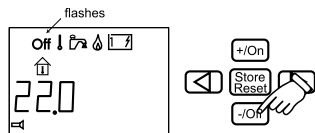

3. The settings are ready. "Off" (main breaker) is shown in the display when the panel returns to standby.

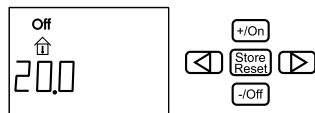

## 4. SET THE TEMPERATURE YOU WANT IN THE VEHICLE



The temperature of the vehicle can be set from +5°C to +30°C at intervals of 0.5°C.

1. Press the button with the arrow until the symbol for selecting temperature flashes.

The temperature shown is the temperature which is set at present (in this case 22.0°C).

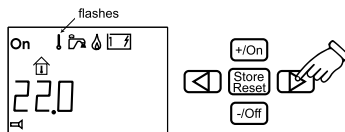

2. Increase the temperature by pressing the +/On button. Lower the temperature by pressing the -/Off button. The diagram shows that we have set the temperature at 25.0°C.

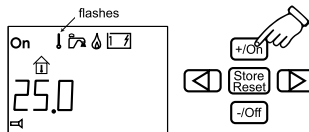

3. The settings are complete and the boiler is working at the set temperature.

## 5. WARM WATER



If you need more warm water you can increase the quantity temporarily for 30 minutes by increasing the water temperature from 50°C to 65°C.

When 30 minutes have elapsed, the water temperature returns to 50°C and the symbol goes out. When you have selected more warm water, the circulation pump stops.

1. Press the button with the arrow until the symbol for selecting warm water flashes. The "OFF" text is shown next to the temperature on the display.

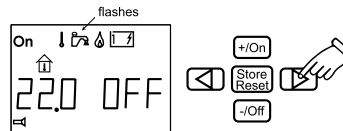

2. Switch the warm water on by pressing the +/ON button. The "ON" text is shown next to the temperature on the display.

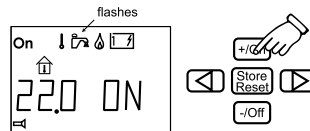

3. The warm water symbol is displayed when the panel returns to standby.

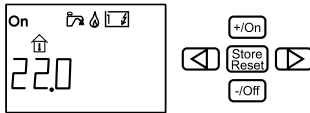

3. The warm water symbol goes out when the panel returns to standby.

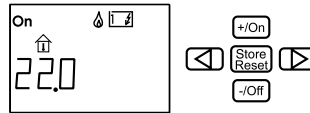

If you want you can switch off more warm water before 30 minutes have elapsed.

1. Press the button with the arrow until the warm water symbol flashes. The "ON" text is shown next to the temperature on the display.

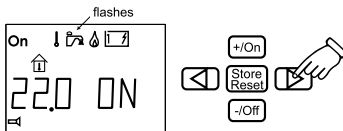

2. Switch off the warm water by pressing the -/Off button. The "OFF" text is shown next to the temperature on the display.

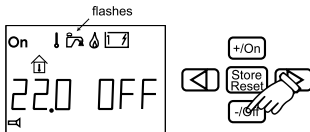

## 6. HEATING WITH GAS



Do as follows to activate heating with gas.

1. Press the button with the arrow until the gas heating symbol flashes. The "OFF" text is shown next to the temperature on the display.

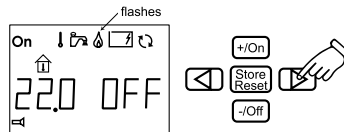

2. Select gas heating by pressing the +/On button. The "ON" text is shown next to the temperature on the display.

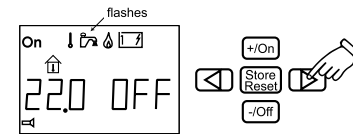

3. The gas heating symbol is displayed when the panel returns to standby.

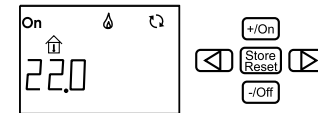

Do as follows to switch off the gas heating.

1. Press the button with the arrow until the gas heating symbol flashes. The "ON" text is shown next to the temperature on the display.

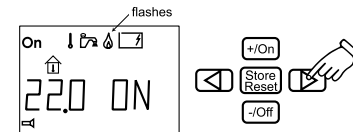

2. Switch off the gas heating by pressing the -/Off button. The "OFF" text is shown next to the temperature on the display.

# Equipment details

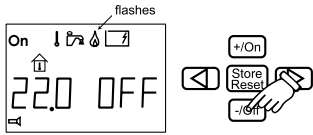

3. The gas heating symbol goes out when the panel returns to standby.

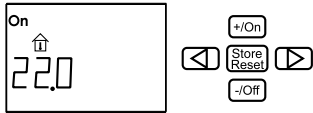

## 7. HEATING WITH ELECTRICITY



To activate heating with electricity. The greater the power the more rapid the heating will be.

1. Press the button with the arrow until the electrical heating symbol flashes. The "OFF" text is shown next to the temperature on the display.

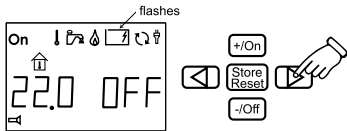

2. Select power (1kW, 2kW or 3kW) with the +/On or -/Off buttons. The diagram shows that 3kW power has been selected (some boilers are only equipped with 1-2kW).

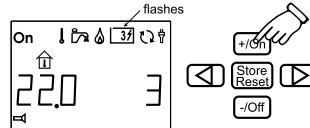

3. The electrical heating symbol is shown when the panel returns to standby.

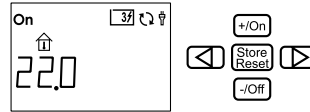

Do as follows to switch off heating with electricity.

1. Press the button with the arrow until the electrical heating symbol flashes.

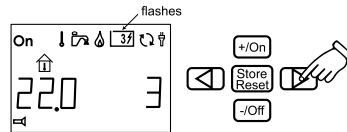

2. Switch off the electrical heating by pressing the -/Off button until all power steps have gone out. The "OFF" text is shown next to the temperature on the display.

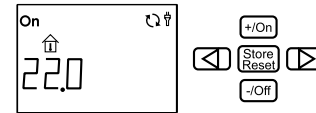

3. The electrical heating symbol goes out when the panel returns to standby.

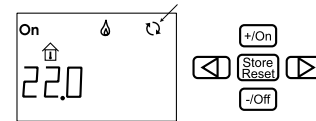

## 8. CIRCULATION PUMP



This symbol is displayed when the circulation pump is operating (12Vpump or 230V-pump).

When heating is required in the vehicle, the pump starts automatically.

The boiler selects the 230V pump if one is installed in the system. When the 230V is disconnected from the vehicle the 12V pump is



automatically selected. The symbol will light up even if the pump is defective.

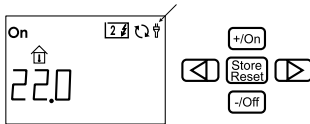

## 9. 230V CONNECTION



This symbol lights up when 230V is connected to the vehicle.

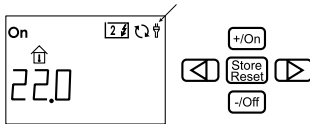

## 10. TEMPERATURE



This symbol shows the indoor temperature in the caravan in intervals of 0.5°C.



This symbol shows the temperature outside the caravan in intervals of 1°C. To use this function an outdoor temperature sensor must be installed.

## 11. WORKING WITH THE LOWER MENU ROW



The lower menu row can be used for such things as setting the clock, external start, night temperature, automatic start of the heater. To use the lower menu row you must activate it by doing as follows:

1. Press the button with the arrow until the symbol for the lower menu row flashes.

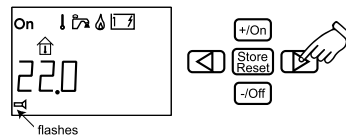

2. Light up the menu row by pressing the +/On button. The lower row with symbols lights up.

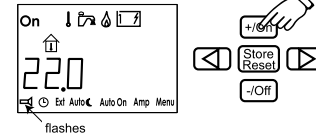

3. To switch off the lower menu row, press the -/Off button when the symbol flashes. Activated functions will be displayed even if the lower menu row is switched off.

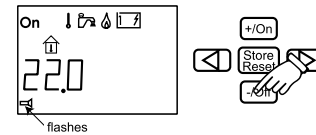

## 12. CLOCK



To set the clock, first light up the lower row of functions (see item 11).

1. Press the button with the arrow until the clock symbol flashes.

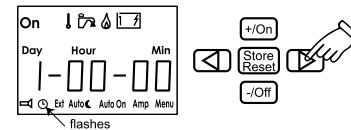

# Equipment details

2. Press the +/-On button. Day flashes. Use +/-On or +/-Off to set the weekday.

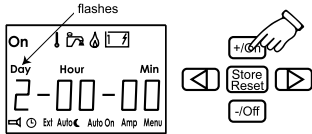

3. Step forward with the arrow key until the time is displayed. Hour flashes. Use +/-On or +/-Off to set the full hour.

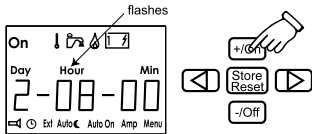

4. Then step forward with the arrow key until the minutes are displayed. Min flashes. Use +/-On and +/-Off to set the minutes.

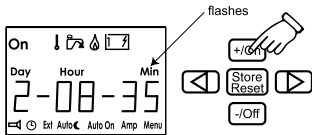

5. Press Store and the time you have set is stored. The example shows Tuesday, 08.35.

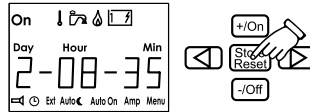

If the power to the panel is broken and the battery backup is not connected, the clock must be set again.

Weekday: 1-7

1=Monday

7= Sunday

Hours: 0-23

Minutes: 0-59

## 13. EXTERNAL START

## EXT

This function is used if you wish to start the heater in the caravan from outside. To use this function it is necessary to have an installation for external start (see vehicle manual). To activate external start, first light up the lower menu row of functions (see item 11).

1. Press the button with the arrow until the "Ext" symbol flashes. The "OFF" text is shown next to the temperature in the display.

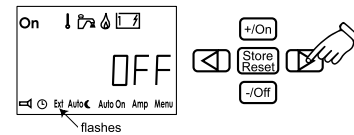

2. Press the +/-On button. The "ON" text is shown next to the temperature in the display.

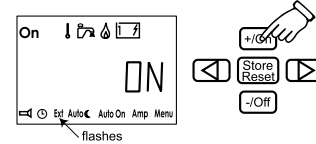

3. Press the button with the arrow until the On symbol (main breaker) flashes. Press +/-Off.

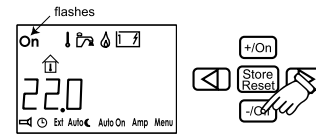

4. Off and Ext are shown in the display when the panel returns to standby. External start is activated.

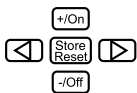
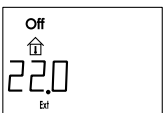

When external start is activated the heater will start with the latest settings and “ON” (main breaker) comes on. If 12V is not connected to the heater, the display will not light up until 12V is connected. The external start function is still activated.

To switch off external start, go to the

“Ext” symbol in the on position and press the -/Off button.

## 14. AUTOMATIC TEMPERATURE Auto CHANGE

This function is used when you wish to set automatic temperature change, for example, during the night.

In order to activate automatic temperature change, first light up the lower row of functions (see item 11).

1. Press the button with the arrow until the symbol for automatic temperature change flashes. The temperature and the “OFF” text are shown on the display.

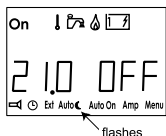

2. Press the +/On button. Set flashes and the OFF text is shown in the display. Press +/On to activate the function. “ON” is shown in the display.

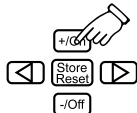
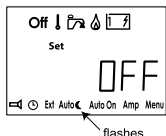

3. Press the left arrow key. The required temperature is displayed. Then adjust the temperature by pressing the +/On or -/Off button.

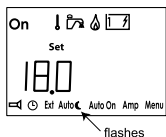

4. Then press Store and the start time is displayed. Adjust the start time (the same procedure as in 12) and press the “Store” button.

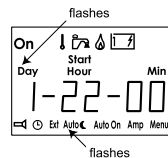

5. Now adjust the stop time and press “Store” again. The text field shows the required temperature and ON.

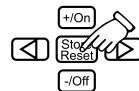
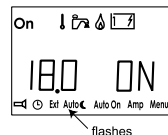

6. If you want the temperature change to be repeated daily, select day 0. Auto is shown in the display when the panel returns to standby.

## 15. STARTING THE HEATER AUTOMATICALLY

### AutoOn

This function is used if you want the heater to start automatically at a later time. The heater works for 24 hours and then stops.

Automatic start is repeated the following week as long as the function is activated.

To activate the function you must first light up the lower row of functions (see item 11).

The function controls the panel’s main breaker.

# Equipment details

1. Press the button with the arrow until the AutoOn symbol flashes. "OFF" is shown in the display. To activate AutoOn, press the +/- On button or the -/Off button to close the function.

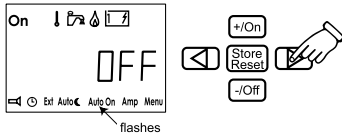

2. The start time will be displayed. Set the time in accordance with item 12 and press "Store" to store the settings. "OFF" is shown in the display.

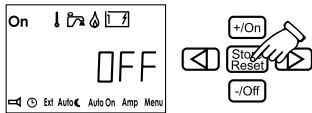

3. Press the +/-On button. On is shown in the display and AutoOn flashes. Set the panel's main breaker to OFF.

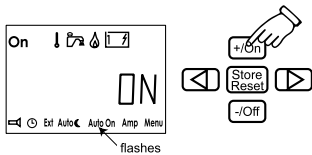

When you get to the vehicle and AutoOn is activated, de-activate AutoOn so that the heater does not stop after 24 hours (the boiler cannot be switched off when AutoOn is activated).

You can then step back with the left-hand button in the settings and press Store in all positions.

## 16. LOAD MONITOR AMP

This function is used if you do not want the 230V fuses to become overloaded. If the vehicle's total current consumption exceeds the set value, the boiler's electrical power will be automatically reduced. On account of voltage variations and tolerances, one can select various control levels (for example, for 6A fuse, one can choose either 5,6,7 Amp setting).

If the fuse does not hold, select a lower set value. The function is disconnected in the factory setting. To activate the function, you must first light up the lower row of functions (see item 11).

1. Press the button with the arrow until the Amp symbol flashes. "OFF" is shown in the display.

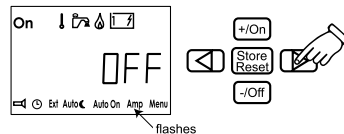

2. Press the -/Off button to activate and set the function. The following values can be set with +/-On or -/Off buttons, 5,6,7,9,10,11,15,16,17.

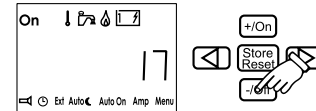

3. Amp is shown in the display when the panel returns to standby.

## 17. MENU Menu

In the "Menu" setting one can activate a number of functions. To activate the function you must first light up the lower row of functions (see item 11). To step between the various functions, use the arrow keys.

### OFFSET (Temperature adjustment)

With this function you can calibrate the temperature on the panel if you notice that the temperature (the stabilised room temperature) does not correspond with the temperature shown on the panel.

1. Press the button with the arrow until the Menu symbol flashes. Press +/-On.

# Equipment details

- When OF is displayed, adjust the temperature displacement with +/-On or -/Off (+/-5°C in intervals of 0.5°C).

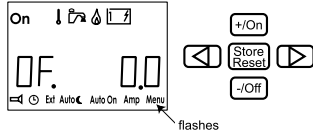

- Press Store to leave the OFFSET function.

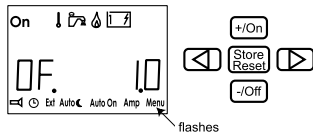

## PUMP 12V/PUMP AU.

The 12V pump is used in the PU 12 setting even if 230V is connected. In the PU AU position, the 230V pump works, and when 230V is disconnected, the 12V pump starts. The PU AU function is activated in the factory setting.

- Press the button with the arrow until the Menu symbol flashes. Press +On.
- When OF is displayed, step with the arrow key until PU AU is displayed. Press +/-On and PU 12 is displayed.

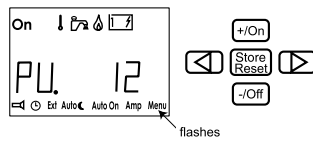

- Press -/Off and PU AU is displayed. Press Store to leave the pump function.

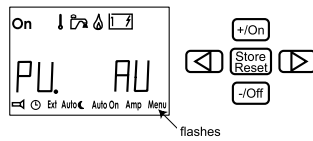

## SERVICE

With this function one can see what values\* from the heater are displayed. The values are updated once per second.

- Press the button with the arrow until the Menu symbol flashes. Press +On.
- When OF is displayed, step with the arrow key until SE is displayed. Press +/-On to see the various values (-/Off can also be used).

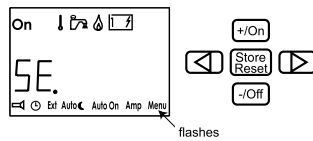

- To leave Service, press Store.

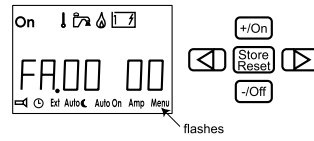

\* The values shown during service are:

**FA (revolutions):** The speed of the fan divided by 2.

**SH (temp):** Warm water temperature.

**HE (temp):** Operating temperature.

**OH:** If the overheating protection has been tripped On or alternatively Off.

**HS (X):** Software version in the heater.

**PS (X):** Software version on the panel.

**I:** Amp. Guideline value shown in steps of 0.5 A.

**WI:** Window breaker on-off.

**ES:** External start on-off.

**10-RS:** Heater information, only for ALDE.

## BUTTON SOUND

With this function you can connect or disconnect the button sound to the buttons. The button sound is disconnected in the factory setting.

# Equipment details

1. Press the button with the arrow until the Menu symbol flashes. Press +On.
2. When OF is displayed, step with the arrow key until Sn is displayed. Press +/On and the button sound is connected.

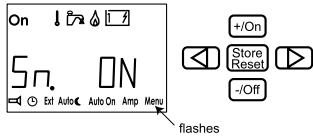

3. Press -/Off to disconnect the button sound. Then press Store to leave the button sound function.

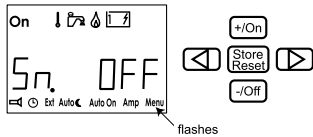

## CONSTANT PUMP OPERATION

With this function, selected pump is in constant operation. The function is disconnected in the factory setting. This function limits the hot water supply, particularly when there is little need of heat.

1. Press the button with the arrow until the Menu symbol flashes. Press +On.
2. When OF is displayed, step with the arrow

key until PE is displayed. Press +/On and constant pump operation is connected.

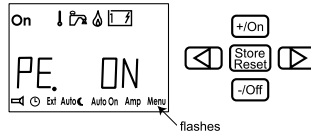

3. Press -/Off to disconnect constant pump operation. Then press Store to leave the pump operation function.

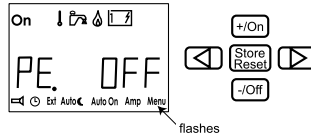

## AUTOMATIC TEMP. INCREASE

At 02.00 hours (night time) the boiler starts and works in accordance with Warm water (item 5) if the clock is set. The reason for this is to reduce the risk of legionella.

The function is disconnected in the factory setting.

1. Press the button with the arrow until the Menu symbol flashes. Press +On.
2. When OF is displayed, step with the arrow key until LE is displayed. Press +/On and legionella is connected.

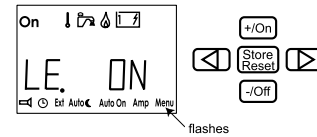

3. Press -/Off to disconnect legionella. Then press Store to leave the legionella function.

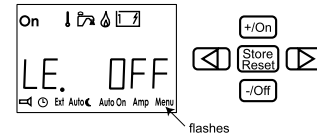

## 18. FAULT MESSAGES

When a fault occurs in the system the reason is shown in the display.

**LOW BAT:** If the vehicle has a battery voltage of less than 10.5V, the heater stops. The heater is automatically reset when the voltage comes up to 11V.

**FAN:** Faulty fan speed. Automatic resetting after 5 minutes.

**GAS OUT:** Gas finished. Resetting by switching off and restarting the boiler in accordance with item 1.

**OHEAT 1:** Overheating protection tripped. To re-set, disconnect 12V from the boiler and connect again.

**OHEAT 2:** Thermostat tripped. To re-set, disconnect 12V from the boiler and connect again.

**WINDO:** Window open, the boiler stops for gas. Gas operation in the boiler starts when the window is closed. Electrical operation functions. Check the vehicle instructions to see whether this function is installed.

**SERIAL:** There is a connection fault between boiler and panel. Normally, this is a mechanical fault in the connection between the heater and panel. To re-set, break the main current and then start again.

## 19. EMERGENCY START

- Disconnect 12V and the cable to the panel on the heater.
- Connect a cable between 2 and 9 in the contact device (on the heater).
- Connect 12V to the heater.

Now the heater starts with gas and 1kW. (Regulation of room temperature does not function, constant pump operation)

## TECHNICAL DATA

### Measurements/Weights

Boiler height: 310mm  
 Boiler depth: 340mm  
 Boiler width: 510mm

Weight: 14kg (without fluid)

Gas	Propane	Butane
Output 1:	3.3kW	3.8kW
Consumption	245g/h	275g/h
Output 2:	5.5kW	6.4kW
Consumption:	405g/h	460g/h
Pressure:	I3+ 28-30/37 mbar I3B/P 30 mbar	

### Volume/Pressure/Temp

Liquid volume radiator water:	3.5 litre
Liquid volume warm water:	8.4 litre
Max pressure radiator water:	0.05MPa (0.5 bar)
Max pressure warm water:	0.3MPa (3.0 bar)

System temperature:  
 max 85°C

### 230V ~

Output element:	1 x 1050W
Output element (2 or 3kW):	1 x 2100W

### 12V DC

Current consumption:	1 amp (max)
Fuse:	3.15 amp+ / 3.15amp-

## Equipment details

### INBOARD WATER TANKS AND ON-LINE WATER SYSTEMS

Please refer to the water system schematic on page 37 with reference to these instructions. Two model specific systems are in use:

- Pressure switched systems in motorhomes with no internal water tank as already described.
- Pressure switched systems in motorhomes with an internal tank, featuring a single pump with valve arrangement to cover all water system requirements.

#### To use the water tank to supply the taps:

- Check the water level gauge on the control panel to confirm the water level within the tank.
- Press the pump button on the control panel

If the taps are closed within the motorhome the pump will run until the correct pressure is attained within the plumbing system. If any of the taps are open water will flow from those taps as soon as the pump is switched on, unless the system is being run for the first time or from a drained condition.

### FLOJET AUTOMATIC WATER SYSTEM PUMP

#### Features

Self-Priming  
Dry Running  
Soft Noise Absorbing Mounts  
Snap-in Port Fittings  
Built-in Bypass Less Pulsation  
Corrosion Resistant Materials  
Meets ISO 8846

#### Specifications

Motor: Permanent Magnet, Ball Bearing Totally Enclosed. CE Models are fully suppressed.

Pump: Three chamber diaphragm design Self-priming up to 9 feet suction lift; Pump able to run dry without damage

#### Operation

With pump switch off and battery fully charged, fill water tank, open all faucets, then turn pump switch on. Water will begin to flow. When the water is free of air, turn faucets off. Remember, you are filling the water heater and pipes.

When all valves are shut-off, pump will stop. Should pump fail to stop, turn switch off and see the trouble shooting.

#### Troubleshooting

**Warning: Before servicing pump, turn off pump and drain water from system!**

#### Failure to prime

##### Motor operates, but no pump discharge

Restricted intake or discharge line  
Air leak in intake line  
Debris in pump  
Punctured pump diaphragm (pump leaks)  
Crack in pump housing

##### Motor fails to turn on

Loose wiring connection  
Pump circuit has no power  
Blown fuse  
Pressure switch failure  
Defective motor

##### Pulsating flow

Restricted pump delivery. Check discharge lines, fittings and valves for clogging or undersizing

##### Pump fails to turn off after all fixtures are closed

Empty water tank  
Insufficient voltage to pump (low battery)  
Punctured pump diaphragm (pump leak)  
Defective pressure switch

##### Low flow and pressure

Air leak at pump intake  
Accumulation of debris inside pump and plumbing  
Worn pump bearing (excessive noise)  
Punctured pump diaphragm (pump leaks)  
Defective motor



### System care and maintenance

#### Winterising

Allowing water to freeze in the system may result in damage to the pump and plumbing system.

Non-Toxic antifreeze for potable water may be used with Flojet pumps. Follow manufacturers recommendations.

**Do not use automotive antifreeze to winterise potable water systems. These solutions are highly toxic and may cause serious injury or death if ingested.**

1. Drain the water tank (if fitted). Open tank drain valve. You may use the pump to drain the tank by opening all the faucets in the system. Allow the pump to operate until the tank is empty. Do not operate the pump more than 15 minutes continuously
2. Open all faucets and purge the water from the plumbing system. Turn power to the pump off. Be sure that all the water from the drain lines are drained

Remove quick connect inlet and outlet fittings from the pump and turn the pump on to pump out remaining water from the pump head. Be sure to have a catch pan or a rag under the pump to prevent water from spilling. Turn the pump off once the plumbing is empty. Leave the fittings disconnected from the pump until the system is ready to be used again. Make a

note on your tank filler that the plumbing is not connected.

Be sure that all faucets are left open to protect against damage to the plumbing.

#### Sanitising

Portable water systems require periodic maintenance to deliver a consistent flow of fresh water. Depending on use and the environment the system is subject to, sanitising is recommended prior to storing and before using the water system after a period of storage.

## Equipment details

### REFRIGERATORS

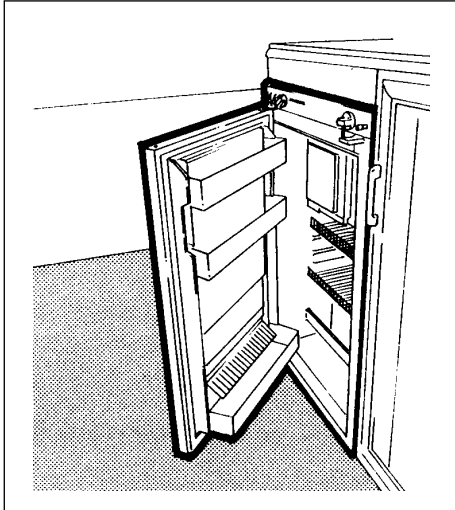

**Before using your refrigerator for the first time, it is advisable to wash the interior and its accessories.**

When using the refrigerator on gas ensure that the gas isolation tap is fully open by turning the knob to the vertical position. The tap can generally be found inside the sink unit or within the wardrobe (model specific). When travelling the fridge can only be Operated in the 12V mode.

**Note: Before operating the refrigerator on**

**12V, it should be pre-cooled, together with its contents, by running it on gas or 230V for a few hours before changing over to 12V for your journey.**

The current drain is approximately 7A to 14A (model specific) and power is only available when the ignition circuit is switched on. On site, only the mains electric or gas modes should be used.

The refrigerator can run on either 230V, 12V or LP gas. Changing between these modes of operation is carried out by means of the controls on the control panel.

**Caution: Only use one source of energy at a time.**

After initial installation, servicing or changing gas cylinders etc., the gas lines may contain some air which should be allowed to escape by briefly turning on the refrigerator or other appliances. This will ensure that the flame lights immediately.

The flame failure device will automatically shut off the gas to the burner if the flame is blown out. On electric ignition versions, the flame failure device will also shut off the gas if the burner does not re-light within about a minute of the flame being blown out.

### THETFORD ABSORBER REFRIGERATORS

This user's information is for Thetford absorption refrigerators. It explains how to use your refrigerator correctly and safely. Read the manual carefully before using the refrigerator for the first time to obtain a quick overview of how to operate and use the refrigerator.

Thetford absorption refrigerators are specially designed to store fresh and frozen food and make ice cubes in caravans and campers. The control panel allows you to select the preferred energy source and cooling level. Different energy sources allow you to use your refrigerator under different conditions.

Thetford absorption refrigerators belong to category C11: gas appliances that must be installed so that the combustion area is isolated from the living space.

To find out more about how your absorption refrigerator works, visit the website at [www.thetford-europe.com](http://www.thetford-europe.com).

#### Precautions and safety instructions

##### Alerts

The following alerts are used in this user's manual:

**Warning!** "Warning" alerts the user to the danger of damage to the product or to the user if the user fails to carry out

## Equipment details

the described procedures carefully.

Non-observance of the procedures may result in serious injury to the user or damage to the product.

**Caution!** “Caution” alerts the user to the possibility of damage to the product if the user fails to carry out the described procedures carefully.

**Important!** “Important” denotes supplementary information for the user and alerts the user to potential problems.

### Warnings

- This refrigerator must be installed according to the manufacturer’s instructions and in compliance with local and national regulations.
- Read this manual carefully before you start to use your refrigerator.
- Always consult the warnings before you perform any maintenance or gas checks.

### Repairs/maintenance

- Never open or damage the cooling system. The cooling system is pressurised and contains substances harmful to health.
- Never attempt to repair gas, extractor or electrical parts yourself. They must be repaired by a qualified service engineer. Contact the Customer Service department

of Thetford for a list of qualified parties.

- Always switch off the refrigerator before you perform any kind of maintenance or cleaning.

### Use

- Never cover the ventilation grills in the walls of a caravan. Good ventilation is essential for the correct working of the absorber system.
- Water in the ventilation grating can result in damage to the refrigerator. Therefore, we advise that you put the winter cover over the ventilation gratings prior to washing your vehicle.
- Never expose the refrigerator to rain.
- Never operate the refrigerator by gas while driving. If a road accident results in fire, there is a risk of explosion.

### What to do if...

- You smell gas:
  - close the valve of the gas bottle;
  - extinguish any naked flames;
  - do not switch on any electrical devices or lighting;
  - open the windows and leave the room;
  - contact the Customer Service department of Thetford.

- You suspect a leak in the cooling system:
  - switch off the refrigerator;
  - extinguish any naked flames;
  - provide sufficient ventilation;
  - contact the Customer Service department of Thetford.

### About your refrigerator

Your refrigerator has a cold space and a freezer compartment. After starting up the refrigerator, allow it to cool for at least eight hours before placing any food in it.

### Cold space

The cooling fins are located on the inside of your refrigerator. The absorption system uses the cooling fins to withdraw heat from the refrigerator. Therefore, never place plastic or paper over the cooling fins. Air must be able to circulate freely through the refrigerator so that heat can be extracted.

**Important! Do not cover the cooling fins at the back of the refrigerator with plastic or paper. The refrigerator cools optimally when air is allowed to move freely through the refrigerator.**

- To limit frosting on the cooling fins:
  - always cover liquid foods before placing them in the refrigerator;

## Equipment details

- always let hot food cool before placing it in the refrigerator;
- never keep the refrigerator open longer than necessary.

### Fitting racks

Inside your refrigerator there are two or three storage racks. You can adjust the racks to a convenient height by means of a simple click system:

- click the plastic bracket to the right short side of the rack;
- turn the bracket into the horizontal position and insert the rack tipped in a sloping position into the refrigerator;
- place the short side without bracket into one of the grooves on the left wall of the refrigerator;
- place the short side with bracket in the corresponding groove on the right wall of the refrigerator;
- turn the bracket downwards to fix it into the groove.

To move a rack, turn the bracket upwards and remove the rack. Place the rack at the required height in the way described above.

### Securing products for driving

The fitting racks in your refrigerator have a system for you to secure products while driving. The system consists of a simple click-

and-slide plastic strip. To secure products on the rack while driving, push the plastic strip as tightly as you can against the products on the rack. In the storage space on the inside of the refrigerator door, there are two unique Thetford bottle slides (see illustration) The slides prevent bottles from sliding around during driving. Push the slide against the products in the door or place the products between the bottle slide .

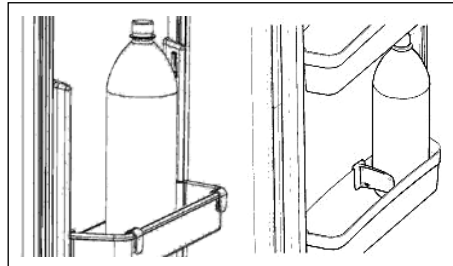

### Freezer compartment

#### Important!

- The freezer compartment is unsuitable as a means of freezing food, the freezer will maintain the temperature of already frozen food
- Use only drinking water to make ice cubes.
- Do not place any other products in the freezer compartment when you are making ice cubes.

- Water freezes fastest with the thermostat at the highest setting.

Tip! Make ice cubes at night when your refrigerator has more spare capacity.

### Door locking mechanism

The refrigerator door has an automatic locking mechanism. The door locks automatically when you press it shut firmly. This automatic locking mechanism also keeps the refrigerator door shut during driving. For some models an additional security device is fitted below the refrigerator. By pushing the locking bar over the pin when the door is closed, you can be sure that the door does not open during your journey.

If you are not going to use the refrigerator for a prolonged period of time, you can use the special storage latch of the door locking mechanism (see illustration) to prevent odours. Rotate the hook through 90 degrees and lock it in place using the strike plate.

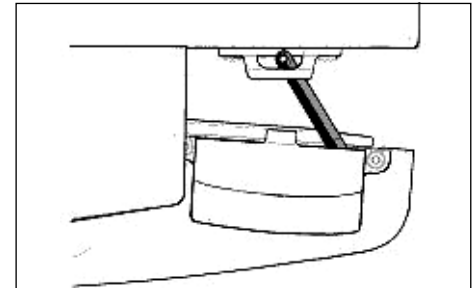

## Equipment details

### Delux refrigerators operation (control panel illustrations 5 and 6)

- It is recommended to clean the inside of the refrigerator before you switch it on.
- Let the refrigerator cool for at least eight hours before you place food in it for the first time.

### Igniting and starting your refrigerator Manual ignition: ILLUSTRATION 5

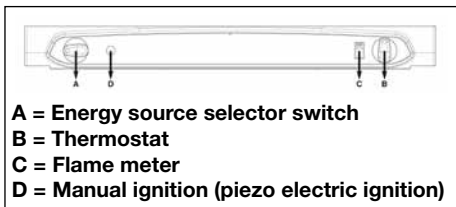



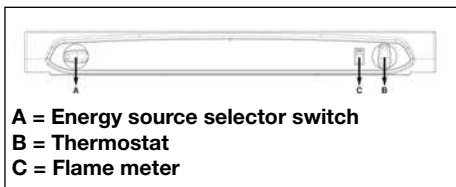

### Electric ignition: ILLUSTRATION 6



- A. The refrigerator can be powered by the mains (230V), direct current (12V) or liquid gas. Select the energy source that you want by means of the energy source selector

switch (A). The switch has four settings:

- direct current (DC) (12V) 
- mains supply (230V) 
- gas 
- switched off 

- B. The thermostat controls the refrigerator temperature when the refrigerator is powered from the mains (230 V) or gas. The refrigeration level is indicated by the dots (the bigger the dot, the colder the setting).
- C. The flame meter shows whether the flame is alight. The flame is alight when the red needle of the meter moves into the green area.
- D. Pressing the manual (piezo electric) starter produces a spark that ignites the flame in the burner.

### Electrical operation

The refrigerator can be powered by electricity in two ways:

- DC (12V): Set the energy source selector switch (A) to  the refrigerator will now be powered by the battery of your car or camper.

**Important! - Always use the gas connection or mains voltage to start up the refrigerator for the first time and to cool it.**

**Powering from the battery of your vehicle is suitable only for maintaining the temperature of the refrigerator and its contents once it has been refrigerated.**

- When powered by a vehicle battery (12V) the refrigerator works without temperature control (i.e. constant operation).
- Mains voltage (230V): set the power selector switch (A) to .
- Set the temperature by means of the thermostat, rotary switch (B). (The bigger the dot, the colder the setting).

### Powering with gas

Warning! - Flammable material must be kept away from the rear of the refrigerator.

- For selection of gas type, see the information plate inside your refrigerator.
- For the pressure regulator model, see the information plate inside your refrigerator and the table at the back of this booklet.
- The type of gas container and its location must be in compliance with the most recent regulations. Ensure that the unit is installed in a location with good ventilation and make sure that the ventilation openings in the gas

## Equipment details

- container storage location remain open.
- The changing of the gas container must be done outside in the open air and out of reach of any possible sources of ignition.
- It is prohibited to use gas to power the refrigerator while you are driving. If a road accident results in fire, there is a danger of explosion.
- You are strongly advised not to use gas to power the refrigerator while you are driving. If a road accident results in fire, there is a danger of an explosion
- You are strongly advised not to use gas to power the refrigerator in the vicinity of petrol stations.
- Open the valve of the gas bottle and the gas taps.
- Set the thermostat (B) to the highest level (the biggest dot)
- Set the energy source selector switch (A) to 
- gnite the gas flame:

### Manual ignition

- Press the thermostat (B), and keep it depressed.
- Press the button for manual ignition several times at intervals of between 1 and 2 seconds.

- Release the thermostat when the indicator of the flame meter enters the green area. If it does not enter the green area, repeat the previous step.

**WARNING! Never keep the thermostat depressed for longer than 30 seconds. If a flame does not appear, wait at least five minutes before trying again. If you fail to observe this rule, there may be an accumulation of gas creating the risk of fire or explosion.**

- Set the desired refrigeration level by means of the thermostat (B). (The bigger the dot, the colder the setting)

### Electrical ignition (illustration 6)

- Press the thermostat (B) and keep it depressed.
- Ignition takes place automatically. You will hear a ticking noise. If ignition was successful, the noise will stop and the flame meter will turn green. Release the thermostat.
- If the flame goes out, ignition will be repeated automatically.
- Set the desired refrigeration level by means of the thermostat (B). (The bigger the dot, the colder the setting)

### Switching off the refrigerator

- Set the energy source selector switch (A) to 
- The refrigerator is now completely switched off.
- Use the special storage latch on the door locking mechanism to stop the door from closing. This prevents unpleasant odours and mould in the refrigerator.

**Important! If you are not going to use the refrigerator for a prolonged period, close the valve of the gas bottle and the gas taps.**

### Premium LCD refrigerator operation (control panel, illustration 7)

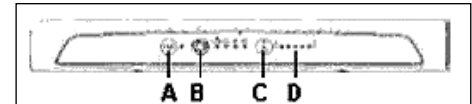

**A = Main switch (on/off)  
B = Mode selection switch  
C = cooling level switch  
D = Display LED**



- It is recommendable to clean the inside of the refrigerator before you switch on the refrigerator.
- Let the refrigerator run for at least eight hours before you place food in it for the first time.

There are two types of LCD refrigerators: Electric and Automatic. Automatic LCD are supplied with the SES system, which allows the consumer to switch the refrigerator in AUTO mode which allows the refrigerator to automatically select the best power source.

### Smart Energy Selection (SES)

When you start up a refrigerator equipped with Smart Energy Selection (SES) you should usually select the AUTO mode. The SES system will then automatically select the best of the three available energy sources.

The system will apply the following priority:

- mains voltage (230V) 
- direct current (12V) 
- liquid gas 

If an energy source becomes available that has a higher priority than the source the refrigerator is currently using (e.g. if your vehicle engine is started), the system will stop using the current energy source and switch to the energy source with the higher priority.

If a fault occurs in one or more of the possible energy sources, the system will not generate an error message while an alternative energy source is still available. The SES system switches over automatically.

If none of the energy sources are available, the blue LED flashes every second and an error code is shown on the display.

Automatic modes additionally allow you to select the desired energy source manually.

### Switching on the refrigerator

**Important! The memory of the SES system saves every change made to the setting. Consequently, the SES system will start up on each subsequent occasion in the last selected setting.**

Illustration 7

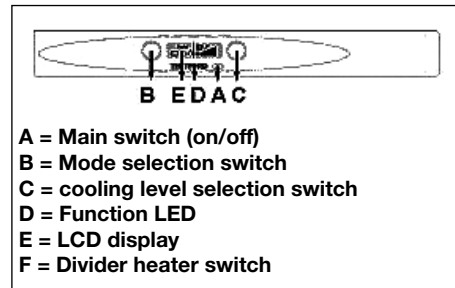

1. Open the valve of the gas bottle.
2. Open the taps of the gas supply.
3. Press main switch (A). The function LED will turn blue and all symbols on the LCD display will light up.
4. Use the mode selection (B) switch to select the 'Auto' function or one of the power supplies that you want. The LCD display

will show the option you have selected.

5. Set the desired refrigerating cooling level by means of the cooling level selection switch (C). The LCD will show the cooling level setting you have selected.
- A. Use the main switch to switch the refrigerator on and off. The function LED will turn blue. The display LCD shows the most recent settings. After 10 seconds the LCD displays backlight will go out. The function LED remains blue.
  - B. Press the mode selector switch and the display LCD display backlight will show the setting for 10 seconds. Pressing the mode selector switch successive times take you through the menu in the following sequence AUTO, manual DC (12V), manual gas, manual mains voltage (230V) and back to AUTO. Select either the AUTO option or one of the other power supplies that you want to use. The LCD display shows the option you have selected. If you select the AUTO option, the system will choose the most suitable power supply and the AUTO symbol and the symbol of the power supply chosen by the system will both be shown on the LCD display. Ten seconds after release of the mode selector switch, the system will switch off the LCD backlight.
  - C. Use the cooling level selector switch to control the temperature of the refrigerator.

## Equipment details

When you press the cooling level selector switch, the LCD backlight will light up and show the currently set temperature. Every time you press the cooling level selector switch you set the refrigerator one position cooler. On reaching the coldest temperature, the system will start again at the warmest temperature setting. Ten seconds after release of the cooling level selector switch, the system will switch off the LCD backlight.

- D. Only the N145 and the N 150 fridges have a divider heater. By heating the metal plate between the freezer and the fridge cabinet, the divider heater prevents the ice forming when the freezer door is opened and also prevents the freezer door from freezing stuck to the metal breaker of the fridge. To save energy the divider heater can be switched off. The switch can be found on the side control panel near the latch

### Powering with electricity

Powering with electricity can be selected both by the Auto mode (only Automatic fridges) and manually.

#### Mains voltage (230V):

This energy source will be selected if the mains voltage is greater than 200V. This power supply requires a continuous current of 12V to operate the electronic control system.

#### Direct current (12V):

- E. The SES system will select 12V powering only if a mains voltage (230V) is unavailable, the vehicle engine is running and a voltage higher than 11V is available. If a fault occurs during electrical powering (230V or 12V), an error message will not be shown on the display as long as another energy source is available. The system will automatically switch to the available energy source that has the highest priority.

#### Selecting electrical power manually Mains voltage (230V):

The LED on the main switch warns you whenever insufficient voltage is available or if a fault occurs. If this happens, the LED will start flashing once per second and an error code is shown on the LED display.

When sufficient current is available again, or the fault has been resolved, the LED will emit a steady blue light again.

#### Direct current (12V):

- Always use a gas connection or mains voltage to start up the refrigerator for the first time and to cool it. Powering from the battery of your vehicle is suitable only for maintaining the temperature and its contents once it has been refrigerated.

The LED warns you whenever your vehicle's engine is not running, or if a fault occurs, or if insufficient voltage is available. If this happens,

the LED will start flashing once per second and an error code is shown on the LCD display.

Once the engine is running, or the fault has been resolved, or sufficient voltage is available again, the LED will again emit a steady blue light.

**Note: If the refrigerator has been manually set to operate at 12V, it will not automatically switch to another energy source when your vehicle's engine is not running. In this case, the refrigerator will stop cooling.**

### Powering with gas

Powering with gas can be selected both by the Auto mode (only Automatic fridges) and manually.

**Warning! Flammable material must be kept away from the rear of the refrigerator.**

- For selection of gas type, see the information plate inside your refrigerator.
- For the pressure regulator model, see the information plate inside your refrigerator and the table in the Thetford user instructions.
- The type of gas container and its location must be in compliance with the most recent regulations. Ensure that the unit is installed in a location with good ventilation and make sure that the ventilation openings in the gas container storage location remain open.



## Equipment details

- The changing of the gas container must be done outside in the open air and out of reach of any possible sources of ignition.
- It is prohibited to use gas to power the refrigerator while you are driving.
- If a road accident results in fire, there is a danger of explosion
- It is prohibited to use gas to power the refrigerator in the vicinity of petrol stations.

### Auto mode

The system will select gas operation if:  
- mains voltage (230V) is unavailable;  
- the vehicle's engine is not running.

Once mains voltage (230V) is available again or the vehicle's engine is running, the system will switch to the available energy source that has the highest priority if in the Auto mode. If the refrigerator switches from 12V DC to gas operation when it is in auto mode, the system will wait for about 15 minutes before igniting the gas. During this time, however, the gas indicator lamp will come on. The delay is built in to avoid it switching to gas operation whenever you stop to refuel your vehicle. You can cancel the delay by immediately switching the refrigerator off and then on again.

If the system selects gas operation, the ignition will be activated automatically. The gas will flow to the burner and be lit by the electric ignition. If the flame goes out, the gas will immediately

be lit again.

### Selecting gas operation manually

If the flame cannot be lit within 30 seconds, the gas supply will stop and gas mode will be switched off. The LED will start flashing every second and an error code is shown on the LCD display.

The gas mode can be reset only if the refrigerator is switched off. If you switch the refrigerator on again and the gas mode is still not working, the LED of the manual gas mode will flash to indicate that gas is unavailable and an error code is shown on the LCD display

**IMPORTANT! It is prohibited to use gas to power the refrigerator while you are driving. If a road accident results in a fire, there is a danger of explosion. It is prohibited to use gas to power the refrigerator in the vicinity of petrol stations.**

**If it takes longer than 15 minutes to refuel your vehicle, you should switch the refrigerator off using the main switch (A).**

### Switching off the refrigerator

- Push the main switch (A).
- The blue LED will go out.
- The refrigerator is now completely switched off.

- Use the special storage latch on the door locking mechanism to fixate the open door. This prevents unpleasant odours and mould in the refrigerator.

### N180

The N180 is the first absorption fridge with three temperature zones. A freezer compartment (up to -180 C). A normal cold section (approx 50 C) and a new cool section (approx 130 C) situated above the freezer compartment in the N180. This new cool section is ideal to store non-perishable products that are best stored in a cool place, like wine, butter, chocolate and bottled water.

### Maintenance

Regular maintenance is necessary to ensure the correct functioning of your refrigerator.

### Cleaning

Tip! A good time to clean your refrigerator is straight after you have defrosted it.

- Clean the refrigerator with a soft cloth and mild detergent.
- Dust the refrigerator with a soft, moistened cloth.
- Use a brush or soft cloth to remove once a year any dust from the condenser at the inside of the refrigerator.

## Equipment details

**Important! - Do not use soap or aggressive detergents that are abrasive or soda-based.**

- The removable interior components of the refrigerator are not dishwasher proof.

### Defrosting

Frost will gradually build up on the condenser of the refrigerator. You should defrost the refrigerator as soon as the frost layer is about 3 mm thick. Frost reduces the refrigerating capacity and life of your refrigerator.

- Remove the ice cube tray and all food.
- Switch off the refrigerator.
- Leave the refrigerator door open.
- Place dry towels in the refrigerator to absorb the water.
- Place trays containing hot water in the freezer compartment.
- After defrosting (when the freezer compartment and condenser are frost-free), remove the towels and the water trays and use a cloth to dry off the refrigerator.
- Switch the refrigerator on again in the way described in section 4.1 (“Igniting and starting your refrigerator”).

**Important! - Do not use force or sharp objects to remove frost.**

- Do not try to accelerate defrosting by using (for example) a hair dryer.

### Door locking mechanism

Frost will form in the refrigerator if the door is not closed properly. To determine whether the door closes properly, close the door with a piece of paper between the door and the refrigerator. Pull at the piece of paper. If you feel resistance, the refrigerator door closes properly. If you feel no resistance, the door does not close properly. Perform this test regularly on all four sides of the refrigerator door.

If you find that the door does not close properly, check whether the door locking mechanism keeps the door properly shut.

### Winter operation

If you use the refrigerator when the outdoor temperature is below 8°C, install the Thetford vent winter/storage cover on the ventilation grills. The cover protects your refrigerator from excessively cold air. The winter cover is a refrigerator accessory obtainable from your caravan dealer.

Tip! It is advisable to use the winter/storage cover if you are not going to use the vehicle for a long period of time.

**Important; do not use the winter/ storage cover in temperatures greater than 8°C as this can damage the cooling unit at the rear of the fridge. Remove the covers and re-fit when placing the vehicle back into storage.**

### Maintenance of gas equipment

A qualified service engineer must maintain and inspect gas and electrical equipment. It is advisable to have this maintenance work performed by a customer service centre. Contact the Customer Service department of Thetford for a list of qualified parties.

**Important! European laws covering gas appliances and extractors prescribe observance of the following rules (which are the user’s responsibility):**

- appliances that run on liquid gas must be inspected before being used for the first time and every year thereafter.
- the gas burner must be cleaned at least once a year or more frequently if necessary.
- If a gas hose is used, it must be checked annually. This hose has a limited life and, thus, must be regularly replaced. Check the hose regularly for cracks, splits and ageing. If in doubt, replace the hose. Pay attention to the maximum life of the hose and replace it in time, as advised by the manufacturer or

in conformance with local regulations.

- For replacement, a gas hose approved in accordance with the local regulations must be used. Position the hose so that it can rotate, is not kinked, and will allow
- Due to the limited life of the gas hose, it must be installed so that replacement is possible.

### Maintenance checklist

This refrigerator will give you many years of trouble-free use if you simply run through the following checklist regularly:

- keep the refrigerator clean (see section 7.1 of the user instruction manual, "Cleaning");
- defrost the refrigerator as often as is necessary (see section 7.2 of the user instruction manual, "Defrosting");
- check the door closing mechanism regularly (see section 7.3 of the user instruction manual, "Door locking mechanism");
- make sure that the ventilation grills are not blocked;
- Regularly clean the ventilation grills.

### Vent screen

The vent has a vent screen to prevent bugs from entering the combustion area of the refrigerators. These vents need to be cleaned regularly to insure a good airflow. When the refrigerator performs poor because of external

circumstances such as extreme ambient temperatures, the vents can be removed to improve the airflow and improve the cooling performance of the refrigerators.

### Storage

If you do not expect to use your refrigerator for a lengthy period, carry out the following actions:

- Remove all food
- Switch off the refrigerator
- Clean the refrigerator as described in Section 7.1 'Cleaning'
- Shut off the gas tap to the refrigerator
- Leave the door of the refrigerator ajar using the special door closure hook (storage position)
- Place the winter protection on the ventilation grill.

### Troubleshooting

If your refrigerator does not refrigerate properly or will not start, run through the following checklist. If this fails to solve the problem, please contact the Customer Service Department in your country (see the addresses at the back of this manual).

- Check whether you have followed the instructions in chapters 4, 5 or 6 of the user instruction manual ("Switching on the refrigerator").
- Check whether the refrigerator is on a level surface.
- Check whether the refrigerator can be used with an available energy source.

## Equipment details

Possible cause	Action you can take
<b>Problem: refrigerator will not work on gas</b>	
a) Gas bottle is empty.	a) Replace the gas bottle.
b) Valve of the gas bottle or one of the shut-off valves is closed.	b) Open the valve of the gas bottle or shut-off valve(s).
<b>Problem: refrigerator will not work on 12V DC</b>	
a) 12V fuse is defective.	a) Fit a new fuse (Camper → fuse box of camper. Car → fuse box of car)
b) Battery is empty.	b) Test the battery and charge it.
<b>Problem: refrigerator will not refrigerate sufficiently</b>	
a) Insufficient ventilation for the refrigerator.	a) Check whether the ventilation gratings are covered.
b) Thermostat set too low	b) Increase the setting of the thermostat
c) Too much ice on the condenser.	c) Check whether the refrigerator door shuts properly and defrost the refrigerator.
d) Too much hot food stored simultaneously.	d) Let the food cool off first.
e) Gas burner is dirty.	e) Have the gas burner cleaned.
f) Door does not shut properly.	f) Check the door closing mechanism.

### Control panel diagnostics

Refrigerators with a LCD control panel have a special diagnostics area which displays an error code if there is a fault.

- Fault 1: AC heater current is measured to be 75% below nominal current.

Action: Contact your dealer or a Thetford Service Centre.

- Fault 2: DC heater current is measured to be 75% below nominal current.

Action: Contact your dealer or a Thetford Service Centre.

- Fault 3: AC heater is ON when it should be OFF.

Action: Contact your dealer or a Thetford Service Centre.

- Fault 4: DC heater is ON when it should be OFF.

Action: Contact your dealer or a Thetford Service Centre.

- Fault 5: Senses flame when gas should be OFF.

Action: Contact your dealer or a Thetford Service Centre.

- Fault 6: Senses gas output terminal ON when should be OFF.

Action: Contact your dealer or a Thetford Service Centre.

- Fault 7: Senses gas output terminal OFF when should be ON.  
Action: Contact your dealer or a Thetford Service Centre.
- Fault 8: AC mains supply is 20% below nominal.  
Action: Your controls are in manual AC mode, but there is no power available. Check if you plugged in the 230V connection, if so the voltage supply on the 230V connection is too low, contact the power supplier.
- Fault 9: Gas lockout because flame fails to ignite after 30 seconds.  
Action: Your controls are in manual gas mode, but the flame fails to ignite. Check if your gas cylinder is empty or if one of the shut-off valves is closed. Select another energy source. Reset the fridge 3 or 4 times in gas-mode until flame ignites. Contact your dealer or a Thetford Service Centre if problem isn't resolved.
- Fault 10: No "engine running" signal is present and control is in Manual DC mode.  
Action: Your controls are in manual DC mode and the engine of your vehicle is not running. The refrigerator can only cool on 12V when the engine of your vehicle is running. Start the engine or select a different energy mode.
- Fault 11: No energy source is available and control is in AUTO mode.  
Action: Your controls are in AUTO mode, but no energy source is available. Start the engine, connect the 230V supply or open the gas supply and reset the refrigerator by turning it off and on again.
- Fault 12: Contact your dealer or a Thetford Service Centre.
- Fault 13: Thermistor fails; control automatically switches to Backup mode (BOS).  
Action: Check if the connector above the fin on the inside of the cabinet is correctly plugged in. If so contact your dealer or a Thetford Service Centre.
- Fault 14: Display Board and Power board lost communication with each other.  
Action: Contact your dealer or a Thetford Service Centre.
- Fault 18: No fault, only lighting all LCD segments on start-up.  
Action: Wait a few seconds for the fridge to start up normally.

## Equipment details

### SPINFLO COOKER 3 BURNER + HOTPLATE

#### OPERATION

##### Burner operation

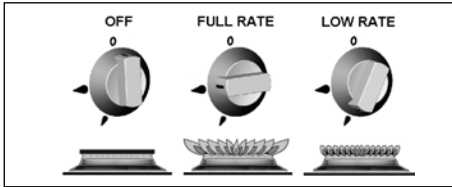

#### IMPORTANT

- This appliance is approved for use with LPG gas; Propane and Butane. We recommend using Propane gas for this appliance.
- Butane gas may be used, although the performance of the appliance may be compromised when the ambient temperature is below 10°C.
- Butane gas should not be used when the ambient temperature is below 5°C.

The burners on this appliance have fixed aeration and no adjustment is required. The burners should flame as follows:-

**Propane** - The flames should burn quietly with a blue/green colour with no sign of yellow tips.

**Butane** - Normally on initial lighting, a small amount of yellow tipping will occur and then slightly increases as the burner heats up.

#### IMPORTANT

- Although each burner will support pans from 10 to 22cm, care should be taken not to overload the appliance as performance may be reduced.
- The following pan sizes are the maximum we recommend:-  
Electric Hotplate:- Ø180mm  
Auxiliary Burner:- Ø200mm  
Semi-Rapid Burner:- 2x Ø200mm or 1x Ø220mm with 1x Ø180mm
- When using small pans the flames should not spread beyond the base of the pan as this will reduce the efficiency of the burner.
- Avoid old or misshapen pans as these may cause instability.
- The lid must be opened fully prior to using the hotplate burners.

#### Using the Hotplate Gas Burners

1. Ensure gas cylinder/supply is connected and turned on. In the event of a gas smell turn off at gas cylinder/mains and contact supplier.
2. Flame supervision: Each burner is controlled individually and is monitored by a thermocouple probe. In the event

of the burner flames being accidentally extinguished, turn off the burner control and do not attempt to re-ignite the burner for at least one minute.

3. To light: Push in the control knob and turn to full rate – see Fig.1. Hold a lighted match or taper to the burner and push the control knob in and hold. It is necessary to hold the knob depressed after the burner has ignited for approximately 10 - 15 seconds, to allow the thermocouple probe to reach temperature, before releasing the knob. Should the flame go out when the knob is released, the procedure should be repeated holding the knob depressed for slightly longer.
4. For models fitted with Spark Ignition the procedure is similar except that the burner can be ignited by depressing the ignition button, which is located on the fascia. If the burner has not lit within 15 seconds the control knob should be released and the burner left for at least 1 minute before a further attempt to ignite the burner.
5. For simmering, turn the knob further anti-clockwise to the low rate position.
6. To turn off: Turn the control knob until the line on the control knob is aligned with the dot on the control panel. Always make sure the control knob is in the off position when you have finished using the hotplate burners.

### OPERATION

#### Using the Electric Hotplate

Ensure the electricity is switched on.

The hotplate control is numbered from 1 to 6. To turn it on, rotate the knob either clockwise or anti-clockwise to the required position. Position 1 is the coolest setting.

To turn the hotplate off, rotate the knob until the line or pointer on the knob lines up with the zero on the control panel.

The hotplate is a sealed construction and transfers heat through conduction. For maximum efficiency a correctly sized pan with a flat heavy gauge base should be used. Pan size should be the same or slightly larger (up to 1" / 2.5cm oversize).

Before using your hotplate for the first time, we recommend that you prime and then season it.

#### To prime the Hotplate

Switch on the hotplate for a short period, without a pan, to harden and burn off the coating.

Use a medium to high setting for 3 – 5 minutes. A non toxic smoke may occur during this process. Allow it to cool, then season.

#### To season the Hotplate

First heat the hotplate for 30 seconds on a medium setting, then switch off. Pour a minimal

amount of unsalted vegetable oil onto a clean dry cloth or paper towel, and apply a thin coat of oil to the hotplate surface. Wipe off any excess oil, then heat the hotplate on a medium setting for 1 minute. Occasional seasoning will help to maintain the Hotplate's appearance.

### WARNING

- Glass lids may shatter when heated. Turn off the hotplate and allow it to cool before closing the glass lid.
- Remove all spillage from the surface of the glass lid before opening.
- The glass lid has the tendency to snap shut towards the end of lowering. This is caused by the travel lock action of the hinges as it is activated. Make sure all fingers are removed from appliance when closing the lid.

### IMPORTANT

- Depending on specification, your appliance may be fitted with a glass lid shut-off system, which cuts off the power to all hotplate burners (gas and electric) if the lid is closed.
- Ensure the glass lid is in the open and upright position before turning on the hotplate burners.
- Not all models are fitted with the shut-off system.

### OPERATION

### WARNING

- The grill area can get hot when the oven is in use, even if the grill is switched off.
- Care should be taken when removing pans from the grill, i.e. use of oven gloves, and by making use of the removal grill pan handle.

### IMPORTANT

- The grill pan supplied is multi functional, for use in grill or oven.
- The handle design allows removal or insertion whilst the pan is in use.
- Always remove the handle when the pan is in use.
- The grill MUST only be used with the door open.

#### Using the Grill

1. Ensure gas cylinder/supply is connected and turned on. In the event of a gas smell turn off at gas cylinder/mains and contact supplier.
2. To light: Open door, push in the control knob and turn to full rate – see Fig 1. Hold a lighted match or taper to the burner and push the control knob in and hold. The burner should ignite and the control knob

## Equipment details

should be held in for 10 -15 seconds before release.

If the burner goes out, repeat procedure holding control knob for slightly longer.

- For models fitted with Spark Ignition the procedure is similar except that the burner can be ignited by depressing the ignition button, which is located on the fascia. Ignition must be carried out with the door open, and if the burner has not lit within 15 seconds the control knob should be released and the grill left for at least 1 minute before a further attempt to ignite the burner.
- Note: the grill must only be used with the door open.
- On first use of the grill, it should be heated for about 20 minutes to eliminate any residual factory lubricants that might impart unpleasant smells to the food being cooked. A non-toxic smoke may occur when using for the first time so open any windows and turn on mechanical ventilators to help remove the smoke.
- Although the grill does heat up quickly, a few minutes preheat is recommended.
- Flame Failure Device (FFD): the grill burner is fitted with a flame sensing probe, which will automatically cut off the gas supply in the event of the flame going out. In the event of the burner flames being accidentally extinguished, turn off the burner control and

do not attempt to re-ignite the burner for at least one minute.

8. It is normal for the flames on this burner to develop yellow tips as it heats up.

9. A reversible grill pan trivet enables the correct grilling height to be achieved.

Fast Toasting                      trivet in high position

Grilling Sausages                trivet in high position

Grilling Steak/Bacon          trivet in high position

Grilling Chops, etc              trivet in low position

Slow Grilling                      trivet removed

10. To turn off: turn the control knob until the line on the control knob is aligned with the dot on the control panel. Always make sure the control knob is in the off position when you have finished grilling.

## OPERATION

### IMPORTANT

- The appliance is fitted with a cooling system. The cooling fans should automatically switch on a couple of minutes after the grill and/or oven is turned on, and will remain on even after the appliance has been switched off.
- The fans should automatically switch off a few minutes after the appliance has been switched off, when the front of the appliance has cooled sufficiently.

- A constant 12V supply is necessary at all times to ensure the cooling system operates correctly.

### Using the Oven

- Ensure gas cylinder/supply is connected and turned on. In the event of a gas smell turn off at gas cylinder/mains and contact supplier.
- To light: Open door, push in the control knob and turn to full rate (240°C). Hold a lighted match or taper to the burner and push the control knob in and hold. The burner should ignite and the control knob should be held in for 10 -15 seconds before release. If the burner goes out, repeat procedure holding control knob for slightly longer.
- For models fitted with Spark Ignition the procedure is similar except that the burner can be ignited by depressing the ignition button, which is located on the fascia. Ignition must be carried out with the door open, and if the burner has not lit within 15 seconds the control knob should be released and the oven left for at least 1 minute before a further attempt to ignite the burner.
- Place the oven shelf in the required position and close the door. Set control knob to approximately 200°C and heat the oven for about 30 minutes to eliminate any residual factory lubricants that might impart unpleasant smells to the meals being cooked. A non-toxic smoke may occur when



using for the first time so open any windows and turn on mechanical ventilators to help remove the smoke.

5. Although the oven does heat up quickly, it is recommended that a 10 minute preheat be allowed. The oven should be up to full temperature in about 15-20mins.
6. To turn off: turn the control knob until the line on the control knob is aligned with the dot on the control panel.
7. Shelf: the shelf has been designed to allow good circulation at the rear of the oven and is also fitted with a raised bar to prevent trays or dishes making contact with the back of the oven. To remove a shelf, pull forward until it stops, raise at front and remove.

### **IMPORTANT**

The pans and trays supplied with this appliance are the maximum sizes recommended for use. Larger pans and trays may restrict good circulation of heat, increasing cooking times.

### **Oven Temperature Control**

The temperature in the oven is controlled by a thermostatic gas tap and is variable over the range 130°C to 240°C. Approximate temperatures for the settings on the control knob are shown in the table below. The temperatures indicated refer to the centre of the oven and at any particular setting the oven

will be hotter at the top and cooler towards the base.

The variation between top and centre, and centre to bottom is approximately equivalent to one gas mark. Good use can be made of the temperature variation in several dishes requiring different temperatures may be cooked at the same time. In this way maximum benefit can be obtained from the gas used to heat the oven. Care should be taken not to overload the oven, adequate spacing being used to allow free circulation for heat.

## **OPERATION**

### **Cooking Guidelines**

Best results will be obtained by the shelf positions in this guide. It is not necessary to preheat the oven but advisable for a range of dishes. The oven is capable of full temperature in 15-20 minutes.

Most cookery books give details of the shelf positions and gas mark settings for each recipe. If in doubt about a recipe you intend to use, study the recipe carefully then find a similar dish in our guide and use our shelf position and gas mark setting recommendation.

Shelf positions are from the top down. When roasting with aluminium foil care must be taken that the foil does not impair circulation or block the oven flue outlet.

## Equipment details

Gas Mark	Temperature			
	(Centre - Shelf Pos. 2)			
¼ - ½	265-275°F	130-135°C	Very cool	Meringues
1	285	140	Cool	Steward fruit
2	300	150	Cool	Rich fruit cake
3	330	165	Warm	Baked custard
4	335	180	Moderate	Victoria sandwich
5	385	195	Fairly hot	Whisked sponges
6	410	210	Hot	Short crust pastry
7	430	220	Hot	Bread, scones
8	445	230	Very hot	Puff pastry
9	465	240	Very hot	Quick browning

Dish	Temp (°C)	Shelf Position	Cooking Time
Scones	220°C	2	8-15 mins
Small cakes	195°C	2	15-25 mins
Victoria sandwich	180°C	2	20-30 mins
Very rich fruit cake	150°C	2	Approx. 60 mins per 500g
Puff pastry	230°C	2	15-30 mins
Flaky pastry	220°C	2	15-30 mins
Shortcrust pastry	210°C	2	15-55 mins
Shortbread fingers	165°C	2	25-30 mins
Ginger nuts	195°C	2	12-16 mins
Rice pudding	150°C	3	100-120 mins
Baked custard	165°C	3	50-60 mins
Fruit crumble	195°C	3	30-40 mins
Beef	165°C 220°C	3	25mins per 500g plus 25mins 15mins per 500g plus 20mins
Pork	165°C 220°C	3	30mins per 500g plus 35mins 25mins per 500g plus 25mins

### IMPORTANT

Always ensure food is properly cooked prior to serving.

### DO'S AND DON'TS

- DO** read the user instructions carefully before using the appliance for the first time.
- DO** allow the oven to heat before using for the first time, in order to expel any smells before the introduction of food.
- DO** clean the appliance regularly.
- DO** remove spills as soon as they occur.
- DO** always use oven gloves when removing food shelves and trays from the oven.
- DO** check that controls are in the off position when finished.
- DO NOT** allow children near the cooker when in use. Turn pan handles away from the front so that they cannot be caught accidentally.
- DO NOT** allow fats or oils to build up in the oven trays or base.
- DO NOT** use abrasive cleaners or powders that will scratch the surfaces of the appliance.
- DO NOT** under any circumstances use the oven as a space heater.
- DO NOT** put heavy objects onto open grill and oven doors.

### LEAKS

If a smell of gas becomes apparent, the supply should be turned off at the cylinder

**IMMEDIATELY.** Extinguish naked lights including cigarettes and pipes. Do not operate electrical switches. Open all doors and windows to disperse any gas escape. LPG gas is heavier than air; any escaping gas will therefore collect at a low level. The strong unpleasant smell of gas will enable the general area of the leak to be detected. Check that the gas is not escaping from an unlighted appliance. Never check for leaks with a naked flame, leak investigation should be carried out using a leak detector spray.

### MAINTENANCE & SERVICING

#### IMPORTANT

- Shut off gas supply at isolating valve, switch off electric supply and ensure all parts are cool before cleaning or servicing
- All servicing must be carried out by an approved competent person.
- After each service the appliance must be checked for gas soundness
- This appliance must not be modified or adjusted unless authorized and carried out by the manufacturer or his representative. No parts other than those supplied by

the manufacturer should be used on this appliance.

- If the supply cord is damaged, it must only be replaced by the manufacturer or his representative in order to avoid a hazard.

This appliance needs little maintenance other than cleaning. All parts should be cleaned using warm soapy water. Do not use abrasive cleaners, steel wool or cleansing powders.

When cleaning the burner ring it is essential to ensure that the holes do not become blocked. The control knobs are a push fit and can be removed for cleaning. They are interchangeable without affecting the sense of operation.

## Equipment details

### SpinFlo COOKER 3 BURNER

**IMPORTANT:** Before using the appliances for the first time, remove all accessories and packing in the grill and oven, including any surface protection film, i.e. plastic coating. Clean all interior surfaces with hot soapy water to remove any residual protective covering of oil and rinse carefully.

#### WARNING

- ACCESSIBLE PARTS MAY BE HOT WHEN THE GRILL IS USED, YOUNG CHILDREN SHOULD BE KEPT AWAY.
- WHEN COOKING ALWAYS ENSURE YOUNG CHILDREN ARE KEPT AWAY.

Ensure the gas cylinder is turned on. In the event of a gas smell, turn off at the cylinder and contact supplier. The burners on this appliance have fixed aeration and no adjustment is required. Depending on the gas being used, the burners should flame as follows:

**PROPANE** - The flames should burn quietly with a blue/green colour with no sign of yellow tips.

**BUTANE** - Normally on initial lighting, as small amount of yellow tipping will occur and then slightly increases as the burner heats up.

**IMPORTANT:** The control tap on this appliance operates both the grill and oven burners.

To ensure safe operation it is not possible to operate both burners at the same time.

#### Using the hob burners

1. Ensure gas cylinder/supply is connected and turned on. In the event of a gas smell turn off at gas cylinder/mains and contact supplier
2. Flame supervision: Each burner is controlled individually and is monitored by a thermocouple probe. In the event of the burner flames being accidentally extinguished, turn off the burner control and do not attempt to re-ignite the burner for at least one minute.
3. To light: Push in the control knob and turn to full rate - see Fig.2. Hold a lighted match or taper to the burner and push the control knob in and hold. It is necessary to hold the knob depressed after the burner has ignited or approximately 10-15 seconds, to allow the thermocouple probe to reach temperature, before releasing the knob. Should the flame go out when the knob is released, the procedure should be repeated holding the knob depressed for slightly longer.
4. For models fitted with spark ignition the procedure is similar except that the burner can be ignited by depressing the ignition button, which is located on the fascia. If the burner has not lit within 15 seconds the control knob should be released and the burner left for at least 1 minute before a further attempt to ignite the burner.

5. For simmering, turn the knob further anti-clockwise to the low rate position.
6. To turn off: Turn the control knob until the line on the control knob is aligned with the dot on the control panel. Always make sure the control knob is in the off position when you have finished using the hotplate burners.

**IMPORTANT:** The two in line hob burners on this appliance will support pans from 10cm to 20cm. The single hob burner will support pans from 10cm to 22cm.

#### WARNING

- GLASS LIDS MAY SHATTER WHEN HEATED. TURN OFF THE HOTPLATE AND ALLOW IT TO COOL BEFORE CLOSING THE GLASS LID.
- REMOVE ALL SPILLAGE FROM THE SURFACE OF THE GLASS LID BEFORE OPENING.

#### Using the grill

#### IMPORTANT

- THE GRILL MUST ONLY BE USED WITH THE DOOR OPEN.
- THE HEAT DEFLECTOR BELOW THE FASCIA SHOULD BE PULLED OUT PRIOR TO LIGHTING THE GRILL. NEVER ADJUST THE HEAT DEFLECTOR POSITION WITHOUT USING HAND PROTECTION I.E. OVEN GLOVES.

## Equipment details

1. Ensure gas cylinder/supply is connected and turned on. In the event of a gas smell turn off at gas cylinder/mains and contact supplier.
2. To light: Open door, push in the control knob and turn to full rate - see Fig 2. Hold alighted match or taper to the burner and push the control knob in and hold. The burner should ignite and the control knob should be held in for 10-15 seconds before release. If the burner goes out, repeat procedure holding control knob for slightly longer.
3. For models fitted with spark ignition the procedure is similar except that the burner can be ignited by depressing the ignition button, which is located on the fascia. Ignition must be carried out with the door open, and if the burner has not lit within 15 seconds the control knob should be released and the grill left for at least 1 minute before a further attempt to ignite the burner.
4. On first use of the grill, it should be heated for about 20 minutes to eliminate any residual factory lubricants that might impart unpleasant smells to the food being cooked. An non-toxic smoke may occur when using for the first time so open any windows and turn on mechanical ventilators to help remove the smoke.
5. Although the grill does heat up quickly, it is recommended that a few minutes preheat be allowed.
6. Flame Failure Device (FFD): The grill burner is fitted with a flame sensing probe, which will automatically cut off the gas supply in the event of the flame going out. In the event of the burner flames accidentally being extinguished, turn off the burner control and do not attempt to re-ignite the burner for at least one minute.
7. It is normal for the flames on this burner to develop yellow tips as it heats up, particularly on Butane.
8. A reversible grill pan trivet enables the correct grilling height to be achieved.  
Fast toasting - trivet in high position  
Grilling sausages - trivet in high position  
Grilling steak/bacon - trivet in high position  
Grilling chops, etc. - trivet in low position  
Slow grilling - trivet removed
9. To turn off: Turn the control knob until the line on the control knob is aligned with the dot on the control panel. Always make sure the control knob is in the off position when you have finished grilling.

### IMPORTANT

- The pan supplied with the appliance is multi functional, for use either whilst grilling or when using the oven.
- The handle design allows removal or insertion whilst the pan is in use.



### Using the oven

1. Ensure gas cylinder/supply is connected and turned on. In the event of a gas smell turn off at gas cylinder/mains and contact supplier.
2. To light: Open door, push in the control knob and turn to gas mark 9. Hold a lighted match or taper to the burner and push the control knob in and hold. The burner should ignite and the control knob should be held in for 10-15 seconds before release. If the burner goes out, repeat the process holding control knob for slightly longer.
3. For models fitted with spark ignition the procedure is similar except that the burner can be ignited by depressing the ignition button, which is located on the fascia. Ignition must be carried out with the door open, and if the burner has not lit within 15 seconds the control knob should be released and the oven left for at least one minute before a further attempt to ignite the burner.

## Equipment details

- Place the oven shelf in the required position and close the door. Set control knob to approximately gas mark 5 and heat the oven for about 30 minutes to eliminate any residual factory lubricants that might impart unpleasant smells to the meals being cooked. A non-toxic smoke may occur when using for the first time so open any windows and turn on mechanical ventilators to help remove the smoke.
- Although the oven does heat up quickly, it is recommended that a 10 minute pre-heat should be allowed. The oven should be up to full temperature in about 15-20 minutes.
- To turn off: Turn the control knob until the line on the control knob is aligned with the dot on the control panel.
- Shelf: The shelf has been designed to allow good circulation at the rear of the oven and are also fitted with a raised bar to prevent trays or dishes making contact with the back of the oven. To remove a shelf, pull forward until it stops, raise at front and remove.

### Oven temperature control

The temperature in the oven is controlled by a thermostatic gas tap and is variable over the range 130°C to 240°C. Approximate temperatures for the settings on the control knob are shown in the table below. The temperatures indicated refer to the centre of the oven and at any particular setting the oven

will be hotter at the top and cooler towards the base.

The variation between top and centre, and centre to bottom is approximately equivalent to one gas mark. Good use can be made of the temperature variation in several dishes requiring different temperatures may be cooked at the same time. In this way maximum benefit can be obtained from the gas used to heat the oven. Care should be taken not to overload the oven, adequate spacing being used to allow free circulation for heat.

### Cooking guidelines

See user instructions.

### Do's and Don'ts

**DO** read the user instructions carefully before using the appliance for the first time.

**DO** allow the oven to heat before using for the first time, in order to expel any smells before the introduction of food.

**DO** clean the appliance regularly.

**DO** remove spills as soon as they occur.

**DO** always use oven gloves when removing food shelves and trays from the oven.

**DO** check that controls are in the off position.

**DON'T** allow children near the cooker when in use. Turn pan handles away from the front so that they cannot be caught accidentally.

**DON'T** allow fats or oils to build up in the oven tray or base.

**DON'T** use abrasive cleaners or powders that will scratch the surfaces of the appliance.

**DON'T** under any circumstances use the oven as a space heater.

**DON'T** put heavy objects onto open grill and oven doors.

### Leaks

If a smell of gas becomes apparent, the supply should be turned off at the cylinder IMMEDIATELY. Extinguish naked lights including cigarettes and pipes. Do not operate electrical switches. Open all doors and windows to disperse any gas escape. Butane/Propane gas is heavier than air; any escaping gas will therefore collect at low level. The strong unpleasant smell of gas will enable the general area of the leak to be detected. Check that the gas is not escaping from an unlighted appliance. Never check for leaks with a naked flame, leak investigation should be carried out using a leak detector spray.

## EXTRACTOR HOOD 524

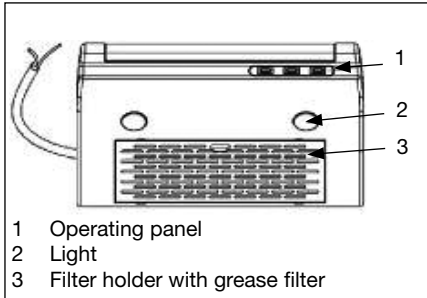

The extractor hood 524 serves to extract water vapour from cooking areas in caravans or campers. The integrated halogen lamps (2) serve to illuminate the work surface.

The fan and the lighting (2) can be switched independently via the operating panel (1). At the same time. The integrated grease filter (3) prevents the extraction system from being contaminated from inside.

**Safety information, always refer to the user instructions provided with your motorhome**

Replacing the lamps

Lamp type: max. 10W /12V halogen with UVStop

Always switch off the lights before replacing the lamps! The lamps get very hot during operation. There is a risk of being burnt. Wait until the lamp has cooled down.

There is a risk of injury if the lamp is broken.

Remove the remainder of the lamp using suitable tools only.

### Replacing or cleaning the grease filter

Flip the front part of the grease filter downwards.

Pull it out towards you.

Remove the filter holder

You can now exchange the filter. Fix the new filter in place with the filter holder. Finally, reinstall the filter unit in the reverse order.

Always switch off the fan motor before replacing the grease filter! There is a risk of injury when reaching inside the running fan.

### Replacing the grease filter

To replace the filter, proceed according to figures 8 & 9.

Flip the front part of the grease filter downwards.

Pull it out towards you.

Remove the filter holder

You can now exchange the filter. Fix the new filter in place with the filter holder. Finally, reinstall the filter unit in the reverse order.

## DOMETIC CK 155 COOKER HOOD

### The fan filter

The fan filter that absorbs grease in cooking fumes requires cleaning now and then, how often depends on how much the cooker is used and for how much the fan is in operation.

Do not wait until the suction power of the fan begins to decrease noticeably.

Cleaning can easily be carried out with hot water to which some synthetic detergent has been added.

### Technical data

Motor power 30 W

Voltage 12 V

Capacity 125 m3/h

Light 2 x 10W, 12V GU4

Spare part number for fuse: 385 80 65-01.

## Equipment details

### MICROWAVE OVEN GENERAL USER INSTRUCTIONS

ALWAYS REFER TO THE MICROWAVE OPERATING INSTRUCTIONS SUPPLIED WITH THE VEHICLE

PRECAUTIONS TO AVOID POSSIBLE EXPOSURE TO EXCESSIVE MICROWAVE ENERGY

- a. **Do not attempt to operate this oven with the door open** since open door operation can result in harmful exposure to microwave energy. It is important not to defeat or tamper with the safety interlocks.
- b. Do not place any objects between the oven front face of the door or allow soil or cleaner residue to accumulate on sealing surfaces.
- c. **WARNING** if the door or door seals are damaged, the oven must not be operated until it has been repaired by a competent person (1) door broken (2) hinges and latches (broken or loosened), (3) door seals and sealing surfaces.
- d. **WARNING** it is hazardous for anyone other than a competent person to carry out a service or repair operation.

e. **WARNING** liquids or other foods must not be heated in sealed containers since they are liable to explode.

f. **WARNING** only allow children to use the oven without supervision when adequate instruction has been given so that the child is able to use the oven in a safe way and understands the hazards of improper use.

g. **WARNING** when the appliance is operated in the combination mode, children should only use the oven under adult supervision due to the temperature generated. (if provided)

### IMPORTANT SAFETY GUIDANCE

**WARNING:** -To prevent fire, burns, electric shock and other warnings:

Listed below are, as with all appliances, certain rules to follow and safeguards to assure high performance from this oven:

### IMPORTANT INSTRUCTIONS

1. Do not use the oven for any reason other than food preparation, such as for drying clothes, paper, or any other non food items or for sterilizing purposes.

2. Do not use the oven when empty, this could damage the oven.
3. Do not use the oven cavity for any type of storage, such as papers, cookbook, cookware etc.
4. Do not operate the oven without the glass tray in place. Be sure it is sitting properly on the rotating base.
5. Make sure you remove caps or lids prior to cooking when you cook food sealed in bottles.
6. Do not put foreign material between the oven surface and door. It could result in excessive leakage of microwave energy.
7. Do not use recycled paper products for cooking. They may contain impurities which could cause sparks and/or fires when used during cooking.
8. Do not pop popcorn unless popped in a microwave approved popcorn popper or unless it's commercially packaged and recommended especially for microwave ovens. Microwave popped corn produces a lower yield than conventional popping; there will be a number of unpopped kernels. Do not use oil unless specified by the manufacturer.



## Equipment details

9. Do not cook any food surrounded by a membrane, such as egg yolks, potatoes, chicken livers, etc., without first piercing them several times with a fork.
10. Do not pop popcorn longer than the manufacturer's directions. (popping time is generally below 3minutes). Longer cooking does not yield more popped corn it can cause scorching and fire. Also, the cooking tray can become too hot to handle or may break.
11. If smoke is observed, switch off or unplug the appliance and keep the door closed in order to stifle any flames.
12. When heating food in plastic or paper containers, keep an eye on the oven due to the possibility of ignition.
13. The contents of feeding bottles and baby food jars shall be stirred or shaken and the temperature checked before consumption, in order to avoid burns.
14. Always test the temperature of food or drink which has been heated in a microwave oven before you give it to somebody, especially to children or elderly people. This is important because things which have been heated in a microwave oven carry on getting hotter even though the microwave oven cooking has stopped.

15. Eggs in their shell and whole hard-boiled eggs should not be heated in microwave ovens since they may explode, even after microwave heating has ended.
16. Keep the waveguide cover clean at all times. Wipe the oven interior with a soft damp cloth after each use. If you leave grease or fat anywhere in the cavity it may overheat, smoke or even catch fire when next using the oven.
17. Never heat oil or fat for deep frying as you cannot control the temperature and doing so may lead to overheating and fire.
18. Liquids, such as water, coffee, or tea are able to be overheated beyond the boiling point without appearing to be boiling due to surface tension of the liquid. Visible bubbling or boiling when the container is removed from the microwave oven is not always present. **THIS COULD RESULT IN VERY HOT LIQUID SUDDENLY BOILING OVER WHEN A SPOON OR OTHER UTENSIL IS INSERTED INTO THE LIQUID.**

### **To reduce the risk of Injury to persons:**

- a. Do not overheat the liquid.
- b. Stir the liquid both before and halfway through heating it.
- c. Do not use straight-sided containers with narrow necks.

- d. After heating, allow the container to stand in the microwave oven for a short time before removing the container
- e. Use extreme care when inserting a spoon or other utensil into the container.

### **CARE OF THE MICROWAVE**

1. Turn the oven off before cleaning
2. Keep the inside of the oven clean. When food spatters or spilled liquids adhere to oven walls, wipe with a damp cloth. Mild detergent may be used if the oven gets very dirty. The use of harsh detergent or abrasives is not recommended.
3. The outside oven surface should be cleaned with soap and water, rinsed and dried with a soft cloth. To prevent damage to the operating parts inside the oven, water should not be allowed to seep into the ventilation openings.
4. If the central panel becomes wet, clean with a soft dry cloth. Do not use harsh detergents or abrasives on Control Panel.
5. If steam accumulates inside or around the outside of the oven door, wipe with a soft cloth. This may occur when the microwave oven is operated under high humidity conditions and in no way indicates malfunction of the unit.

## Equipment details

6. It is occasionally necessary to remove the glass tray for cleaning. Wash the tray in warm sudsy water or in a dishwasher.
7. The roller guide and oven cavity floor should be cleaned regular/y to avoid excessive noise. Simply wipe the bottom surface of the oven with mild detergent water or window cleaner and dry. The roller guide may be washed in mild sudsy water.
8. The oven should be cleaned regularly and any food deposits removed;
9. Failure to maintain the oven in a clean condition could lead to deterioration of the surface that could adversely affect the life of the appliance and possibly result in a hazardous situation.

## THETFORD CASSETTE TOILET

C-200 CW and C-200S (Manual) and  
C-200CWE & C-200CS (Electric)

C-200 S/CS: models that are connected to  
the vehicle's water tank.

C-200 CW/CWE: models that have their own  
flush-water tank

### Features

1. Removable seat and cover.
2. Rotatable bowl.
3. Valve blade handle: opens and closes valve blade.
4. Flush-handle activates the flush by lifting and pushing down the handle.
- 4a C-200 CWE & CS. Flush button: activates flush.
5. Power-supply for the waste-level indicator: two batteries, type: Penlite 1,5V AA alkaline.
6. Waste-level indicator: indicates when holding tank requires emptying.
7. Rotating pour out spout: makes emptying holding tank easy and convenient.
8. Upper carrying handle
9. Automatic holding tank vent: vents the holding tank when the tank is inserted in the toilet. This prevents under- or overpressure in the holding tank.
10. Valve blade opener.
11. Sliding cover: closes holding tank is taken out. Guarantees optimal hygiene.
12. Valve-blade
13. Vent button: vents the holding tank to avoid splashing while emptying.
14. Hand grip
15. Access door
16. Waterfill door

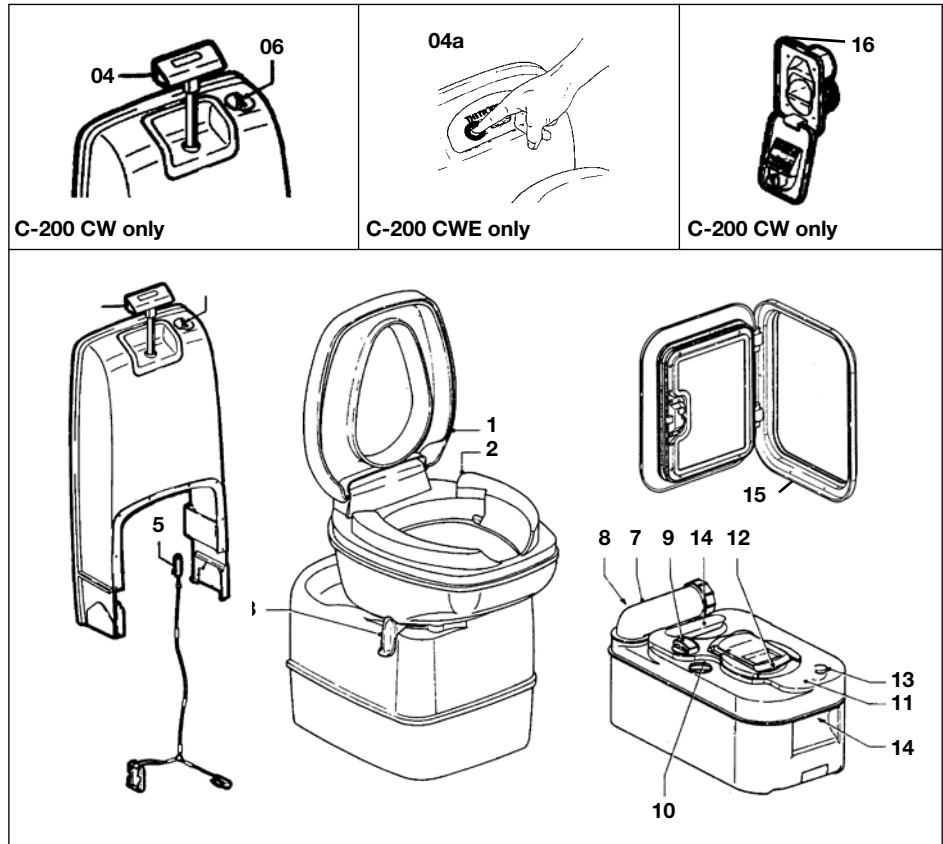

## Equipment details

### Cassette C-200 CW, C-200 CWE & C-200CS

The toilet section of the C-200 includes a rotatable bowl, removable seat and cover, a console with a flush handle/flush buttons, a built in flush-watertank and a waste level warning indicator. The valve blade handle is located underneath the bowl.

#### Preparing for Use

1. Open access door pull retaining clip upwards (fig. 1).
2. Remove holding tank by pulling straight out. When holding tank hits the stop, tilt front end downwards slightly and remove (fig. 2).
3. Position tank vertically and swivel pour out spout upwards (fig. 3).
4. Remove the cap of the pour out spout. Add required quantity of toilet fluid through pour out spout then add approx. 2 litres of water through the spout to cover holding tank bottom. Replace cap and return pour out spout to its original stored position (fig. 4).

Note: Warmer weather or longer intervals between emptying the waste tank may require additional toilet fluid. Use only Thetford toilet fluid to achieve the best results.

**Caution: Never add toilet fluid directly into toilet bowl.**

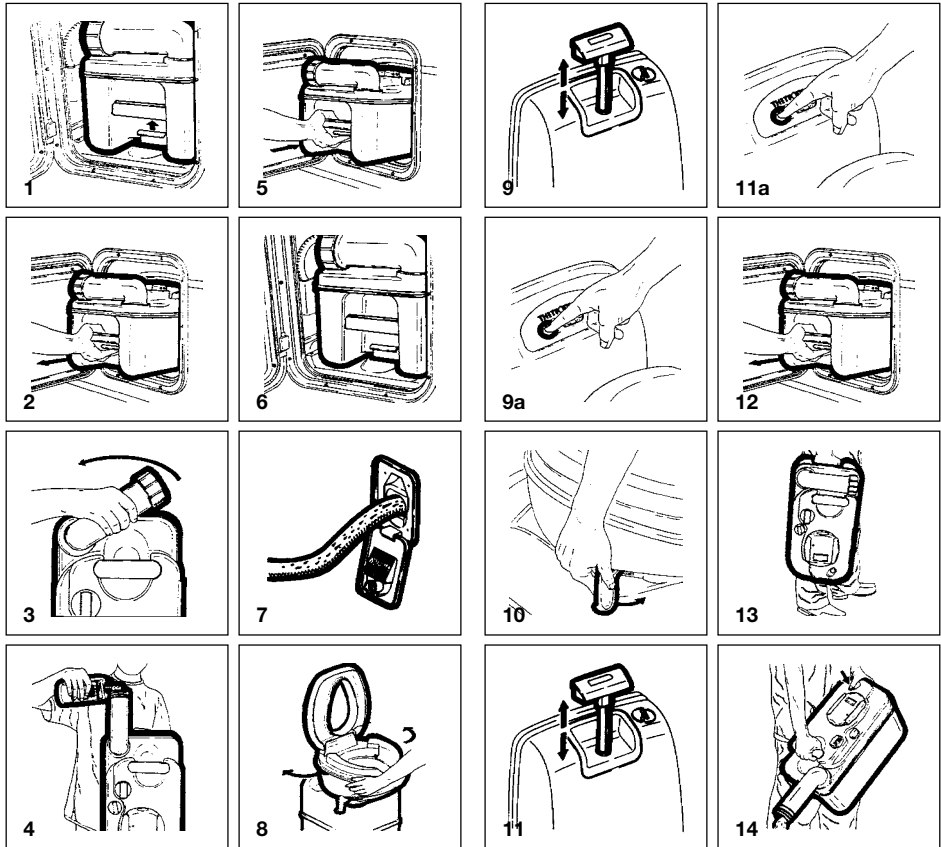

5. Slide the holding tank into position through access door (fig. 5).
6. Make sure the holding tank is secured by the retaining clip. (fig. 6).
7. Open the waterfill door and add 50 ml of Aqua Rinse. Aqua Rinse results in a better flush and improves the hygiene of the toilet. Then fill the watertank with fresh water using a jerrycan or a hose. Tank capacity is 7 litres (fig. 7).

### Operation

8. Turn the bowl in the most comfortable position (fig. 8).
9. **C-200 CW only:** Before using the toilet it is recommended to flush some water into the bowl by lifting and pressing down the flush handle (fig. 9).
- 9a. **C-200 CWE & CS only:** Before using the toilet it is recommended to flush some water into the bowl by pressing and releasing the flush button (fig. 9a).
10. The toilet may be used with the blade open or closed. Pull valve handle towards you to open (fig. 10).
11. **C-200 CW only:** After use, open valve blade (if still closed) and flush, lift the flush handle and press it down (fig. 11). After flushing, close the blade by turning the blade handle.

- 11a. **C-200 CWE & CS only:** After use, open valve blade (if still closed) and flush, press the flush button (fig. 11a).

After flushing, close the blade by turning the blade handle.

The waste holding tank is located underneath the toilet and is removed for emptying from the outside of the vehicle through an access door. A rotating pour out spout, automatic holding tank vent, air release valve, valve blade, carrying handles and hand grip are incorporated in the waste holding tank. A sliding cover guarantees optimal hygiene.

### Emptying the Holding Tank

The holding tank capacity is approx. 17 litres and the tank should be emptied when the waste-level indicator lights up. The waste-level indicator lights up when the holding tank contains more than 15 litres of waste.

**CAUTION: Do not allow the holding tank to become overfilled. See trouble shooting section for emergency emptying procedure.**

12. Open access door and remove the holding tank. The holding tank can only be removed when the valve blade is closed (fig. 12).
13. Carry the holding tank to a normal household type toilet or other authorised disposal point. Place the holding tank in vertical position and rotate pour out spout upwards (fig. 13).

14. Remove the spout cap. Grasp unit by upper carrying handle nearest to pour out spout. Place other hand on upper rear hand grip so that vent button can be depressed with the thumb while emptying. This ensures a smooth outflow of the tank contents. (fig. 14).

Note: Only depress the vent button when pour out spout is pointed downwards.

Rinse the holding tank with clean water. For preparing for use again, see steps 1 to 7.

### Cleaning and maintenance

The lipseal and the seal of the automatic vent are made of rubber and therefore these parts need regular maintenance (depending on frequency of use, once or twice a month).

## Equipment details

**Lipseal:** Remove the sliding cover. Open the valve-blade by turning the blade-opener knob anticlockwise. Clean the seal with water. Dry the seal and grease with silicone spray/oil or vegetable oil.

**Seal of automatic vent:** Turn the automatic vent 60° anticlockwise and remove gently. Clean the seal with water. Dry the seal and grease with silicone spray/oil or vegetable oil.

To clean the holding tank, empty the tank, and rinse with clean water. Use a mild soap to clean toilet bowl, seat and cover, as well as exterior of toilet unit and holding tank.

**NOTE:** Do not use strong household detergents or cleaners that contain chlorine, solvents or acid contents.

### Wintering/storage

The Thetford Cassette C-200 CW/CWE/CS is easily winterised for storage.

Empty remaining fresh water into the bowl by activating the flush handle up and down (C-200 CW) or by pressing the flush button (C-200 CWE & CS).

Once pump has been cleared and water flow has stopped completely, release into waste tank. Remove waste tank and empty contents in normal way.

To evacuate any remaining water from the fresh

water tank, either place a container underneath the drainplug and remove drainplug or drain from the tap situated below the skirt panel (model specific).

When procedure has been completed replace drainplug and waste holding tank (fig. 15). Clean the seals and grease them after drying (see cleaning and maintenance).

Leave the blade of the holding tank open. Do not replace cap on the pour out spout, to ventilate the holding tank. (Also grease the seal of the pour out spout cap.)

### Cold weather use

The toilet can be used in cold weather conditions provided that the toilet is in heated surroundings. If this is not the case, you can use a nontoxic antifreeze (propylene glycol) or an antifreeze such as those used in car radiators. Add the antifreeze to the water in the tank. Add the quantity specified in the instructions, paying due regard to the safety instructions.

### High altitude and warm weather use

Pressure may build up in the holding tank if the tank is not inserted while driving at high altitudes or in warm weather conditions. The automatic holding tank vent will vent the tank when there is over- or under-pressure. High

temperatures may require additional Thetford toilet fluid.

### Thetford warranty

1. The Thetford Cassette is warranted for one year from the date of purchase, please fill in and return the warranty card.
2. The warranty covers replacement of defective or flawed parts and the inadequate performance of the toilet.
3. In case of a defect apply to an original dealer or Thetford Service Centre with proof of purchase.
4. Defects, which in our judgement occurred from misuse, negligence or accident, are not covered by the warranty. In addition, the warranty does not apply if the product is installed or handled improperly or if other than the prescribed toilet fluids have been used or if the product has been altered in any way or has been repaired by unqualified persons, or if the serial number and/or date has been altered or removed.
5. Should the original buyer wish to return to us parts believed to be defective, the parts should be sent prepaid. If we find the parts defective and covered by warranty, they will be repaired and returned. If warranty does not apply or has expired, a nominal charge will be made. Any transport costs are for the account of the owner.

## Equipment details

6. Before returning product or parts they should be properly cleaned, in order to carry out inspection and repair.
7. No other warranty is given and no personal representative is authorised to make any warranty other than that is contained herein.

### THETFORD C250 CWE,C250S AND C250CS CASSETTE TOILET

The Thetford Cassette Toilet is a high quality product. The toilet forms an integral part of your caravan or motorhome bathroom, thanks to its functional design which combines modern styling and ease of use. The C-250 Cassette Toilet is manufactured from high quality synthetic materials which makes it a durable, user and maintenance friendly toilet.

The toilet is made up of two parts: a permanently fixed part and a Waste Holding Tank that is accessible from the outside. The removable Waste Holding Tank is located under the toilet bowl and can be removed via a door on the outside of the caravan or motorhome. The Thetford Cassette Toilet is the solution to the sanitary problem in your caravan or motorhome!

These instructions cover the C-250CWE this has its own flush-water tank.

### PARTS

- a) Removable Seat and Lid
- b) Swivelling Toilet Bowl
- c) Blade Handle
- d) Flush Button
- e) Waste Holding Tank Level Indicator
- f) Water Filling Door (only if toilet has own flush-water tank)

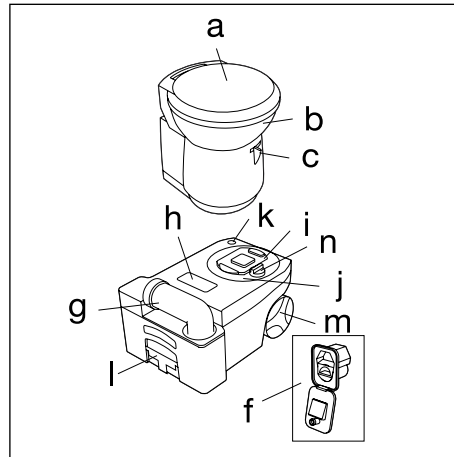

- g) Rotating Emptying Spout
- h) Automatic Pressure Release Vent
- i) Sliding Cover
- j) Removable Mechanism
- k) Vent Plunger
- l) Pull-Out Handle

- m) Wheels
- n) Blade Opener
- o) Access Door to Waste Holding Tank

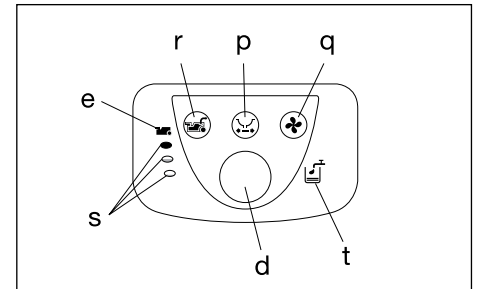
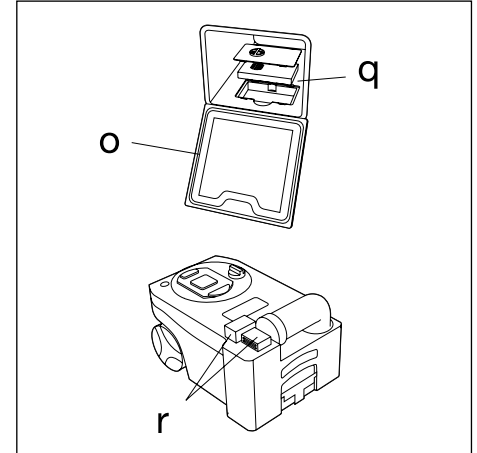

# Equipment details

## Optional Features

- p) Electric Blade
- q) Automatic Ventilator
- r) Waste Pump-Out System
- s) Waste Holding Tank Multi-Level Indicator
- t) Flush-Water Tank Level Indicator (only if toilet has its own flush-water tank)

## Control panel

Preparing for use (standard)

1. Open the access door on the outside of your caravan or motorhome
2. Remove the Waste Holding Tank by pulling the safety catch (which holds the tank in place) upwards.
3. Pull the Waste Holding Tank outward to the stop. Tip it slightly and take the tank fully out.
4. Place the tank upright and turn the rotating emptying spout upwards. The emptying spout ensures that the tank can be easily and hygienically emptied.
5. Remove the cap, with the measuring cup inside, from the emptying spout and pour the correct dosage of Thetford toilet fluid (see product label) into the holding tank. This avoids unpleasant smells and keeps the inside of the tank clean. Next add approximately 2 litres of water - enough to ensure that the bottom of the

Waste Holding Tank is covered. For more information on Thetford toilet fluids, see last page of the Thetford user manual. Screw the cap back onto the emptying spout and turn back to its original position.

**Note. The Emptying Spout Measuring Cap is supplied in the same packaging as the Thetford user manual.**

**Warning! Never add toilet fluid directly via the blade or the toilet bowl as this could damage the lip seal of the Waste Holding Tank. Always pour the fluids via the emptying spout.**

6. Slide the Waste Holding Tank back into its original position via the access door. Make sure that it is secured with the safety catch. Close the access door and lock it. Your Thetford toilet is now ready to use.

**Warning! Never use force if you cannot get the tank back into place easily. This may cause serious damage. If blockage occurs, always check if the blade handle is in the correct (closed) position.**

7. For toilets with own Flush-Water Tank: Open the water filling door and fill the flush-water tank with the correct dosage of Aqua Rinse. This Thetford toilet fluid keeps the

flush water fresh and improves the flushing. Next, fill up the flush-water tank with clean water (approximately 8 litres) using a jerry can or hose. Your toilet is now ready to use.

## Preparing for use with optional features

8. Automatic Ventilator: Open the access door on the outside of your caravan and remove the Waste Holding Tank (as described above).
9. Remove the filter housing cover and if no filter is present, place a new filter into the filter housing. Peel off the sticker lids on the filter. Place back the cover of the filterhousing.

## Using the toilet (standard)

10. Turn the bowl to the desired position with the lid closed and using both hands.
11. To activate the control panel, press the flush-button once. The control panel display will stay activated for approximately 5 minutes. Run some water into the bowl by pressing the flush button again briefly.
12. The toilet may be used with the blade open or closed. To open the blade, slide the blade handle under the toilet bowl sideways. After use, open the blade (if still closed) and flush the toilet by pressing the flush button for several seconds (if necessary re-activate the control panel). Close the blade after use.



**Important Warning Notice! If your toilet has its own flush-water tank, please make sure that you do not travel with a flush-water tank that is too full. Do not travel with water in the toilet bowl. Failure to adhere to this notice may result in water damage to your caravan or motor home.**

### Using the toilet with optional features

13. Electric Blade: Push the electric blade button on the control display to electrically open or close the blade. In the case of failure, you can manually open or close the blade by sliding the small handle under the toilet bowl sideways.
14. Automatic Ventilator: The ventilator automatically starts when the control panel is activated (by pressing the flush button) and will automatically shut off after approximately 5 minutes. The Automatic Ventilator Indicator will flash until automatic shut-off occurs. If you want to stop the ventilator, press the Automatic Ventilator button. If you want to re-start the ventilator, press the button again (the LED will start flashing again).
15. Flush Water Tank Level Indicator (only for toilets with own flush-water tank): When the Flush Water Tank Level Indicator lights up, refill the flush-water tank, as only about 1.5 litres of water is left in the tank, which is sufficient for approximately 2 flushes.

### Emptying

The Waste Holding Tank has a capacity of 18 litres and requires emptying when the red light (LED) on the toilet control display lights up, when the Waste Holding Tank only has capacity for approximately 2 more litres, which is no more than two to three further uses. Make sure that the blade is closed. Open the access door located outside the vehicle, pull the safety catch upwards and remove the Waste Holding Tank.

16. Place the Waste Holding Tank in an upright position (Pull-Out Handle at the top, Wheels at the bottom). Slide the handle sideways - to the front of the tank - until it snaps out of its locked position.
17. Pull the handle up and wheel the Waste Holding Tank to an authorised waste disposal point.
18. Push the handle back into its locked position. Turn the emptying spout upwards and remove the cap from the spout. Hold the Waste Holding Tank in such a way that during emptying you can operate the vent plunger with your thumb. To empty the tank without splashing, depress the vent plunger while emptying the tank. After emptying, rinse the tank and blade thoroughly with water.

**Warning! Do not seriously shake the tank or use high pressure water cleaners. This may cause damage to the tank's interior.**

**Note. The vent plunger should only be depressed once the emptying spout is pointing downwards. Prepare the toilet for re-use if required. Slide the Waste Holding Tank into the toilet and close the access door.**

### Emptying with optional features

19. Waste Holding Tank Multi-Level Indicator: The lower lamp indicates that the Waste Holding Tank is almost empty; the middle lamp indicates that it is more than half full; when the upper lamp lights up, the tank needs emptying as it can only take 2 - 3 further uses.

**Note. The Waste Holding Tank Level Indicator will flash when the holding tank is not present. In this case the toilet will not flush.**

20. Waste Pump-Out System: When activating the control panel this feature automatically lights up. When the Waste Holding Tank Level Indicator illuminates, press the Waste Pump-Out button to pump out the waste from the holding tank into the vehicle's waste tank. The button will flash while the waste is being pumped and will stop automatically (after approximately 5 minutes) when all waste has been transferred.

## Equipment details

If the vehicle's waste tank is full, the Waste Pump-Out light will flash rapidly and no pump-out will be possible until the central tank is emptied. (Check the level of the vehicle's waste tank on the vehicle's central console). After the Waste Holding Tank has been emptied, there will be approximately 1.5 litres of waste left in the tank. This is normal. Add 2 litres of water and a correct dosage of Thetford toilet fluids to the Waste Holding Tank.

**Important! It is vital that the correct amount of toilet fluid is added to ensure the proper breakdown of the waste in the holding tank. Only use the system when the tank is full. Using the system too often on an empty tank can cause damage to the pump, which could cause the system to fail.**

### Cleaning and maintenance

The toilet should be cleaned and maintained regularly, depending on the amount of use. To clean Thetford toilets, we advise using water and Thetford Bathroom Cleaner.

Note. Never use bleach, vinegar or other powerful household cleaners that contain these substances. These may cause permanent damage to the seals and other toilet components.

#### Toilet bowl

- Squirt Thetford Bathroom Cleaner into the toilet bowl.

- Flush the toilet bowl with water and wipe down the rest of the toilet with a damp cloth.
- Clean seat and lid The seat and lid can easily be removed: Lift the seat and lid assembly and pull the round pins (inside the assembly) outwards from the pin holes. After cleaning, replace the seat and lid by positioning the round pins in front of the pin holes and push the lid and seat downwards.
- To keep your flush water fresh and to prevent deposits from forming in your toilet bowl, add a correct dosage of Aqua Rinse in your flush water tank, if present, on your toilet.

Tip! For a really shining toilet, dry with a soft dry cloth after cleaning.

#### Waste holding tank

To keep your Waste Holding Tank fresh and clean, Thetford has developed a number of different toilet fluids. Thetford toilet fluids suppress smells, reduce formation of gas, promote breakdown of toilet waste and increase the life span of a mobile toilet. See page 46 of the Thetford user manual for more information (=matrix). We advise a thorough cleaning of the Waste Holding Tank once each season. Next to using Thetford's Cassette Tank Cleaner, the powerful cleaning agent for the periodical cleaning of the Waste Holding Tank of your toilet, we suggest the following:

- Remove the removable mechanism from

the Waste Holding Tank by turning it anti-clockwise and rinse it under a tap.

- Remove the cover plate from the Automatic Pressure Release Vent by prising it up using a small screwdriver. Use one hand to push the Automatic Pressure Release Vent open while holding the float of the Automatic Pressure Release Vent on the inside of the tank with the other hand. Push the float upwards, turn it 180 degrees and remove it from below. Remove the rubber seal underneath the float. Rinse the float and rubber seal under a tap. Replace the Pressure Release Vent using the same method in reverse.

The rubber seals in the toilet (the lip seal, the mechanism seal, the automatic pressure release vent seal and the cap seal) should be regularly cleaned with water and treated with Thetford High Grade Seal Lubricant. This will ensure that the seals remain flexible and in good condition. If the toilet is not to be used for any length of time, it is important to treat the seals with Thetford High Grade Seal Lubricant after cleaning.

**Note. Never use Vaseline or any vegetable oil except olive oil. These may cause leakage or malfunction. The lip seal is a part of the toilet that is subject to wear. Depending upon the extent and manner of use, the seals will become less effective and will need replacing periodically.**

### Cleaning and maintenance for optional Features

- **Automatic Ventilation:** The filter of the Automatic Ventilation needs to be renewed periodically. After approximately 4 full weeks of use, the filter loses its absorption power.
- **Pump-Out Waste System:** To ensure optimal functionality of the Pump-Out Waste System, periodical maintenance of the tube and pump is recommended. After emptying the Waste Holding Tank completely, fill it with clean water and empty it again. This will clean the pump and the hose. Do this once every 3 weeks when on holiday. This should ensure proper operation of the system.

### Winter operation

You can use your Thetford Cassette Toilet as normal in cold weather as long as the toilet is situated in a heated location. If there is a risk of freezing we advise that the toilet is drained by following the instructions under 'Storage'. For environmental reasons the use of antifreeze, such as that used in car radiators, is not recommended.

### Storage

It is important that you follow the instructions below if you do not expect to use your Thetford toilet for a long (winter) period.

- Activate the Control Panel by pressing the flush button. Open the blade and press the

flush button until water stops flowing into the bowl. Close the blade. Open the access door on the outside of your caravan or camper and empty the Waste Holding Tank at an authorised waste dump. Follow the instructions for cleaning and maintenance. To allow the Waste Holding Tank to dry, do not place the cap back on the emptying spout of the tank.

21. If the toilet has its own flush-water tank, place a sufficiently large bowl under the drain tube to catch the remaining water from the flush-water tank and remove the drain plug. When no more water exits, put the drain plug on the drain tube, put it back in its original position and close the access door. If the toilet is connected to the vehicle's water tank, please follow your vehicle's instructions for draining the central water system. If your toilet is optionally featured with a Waste Pump-Out System, take out the Waste Holding Tank and completely clean it (see Cleaning and Maintenance). After cleaning, fill it with water, put it back and empty it via the waste pump-out system. Repeat this twice.

Thetford warranty refer to the Thetford user handbook.

## Equipment details

### WINDOWS



To open, turn knobs anti-clockwise and open catches. Swivel the window pane open to the desired position and close knobs clockwise to lock in the open position.

To close, reverse the operation.

All opening windows have two catch positions. The first position is for ventilation the second seals the window from ventilation and rain.

### KOMFORTROLLO BLINDS (SEITZ)



#### Blinds and Flyscreens

Flyscreen and blinds operate in the same manner. The flyscreen can only be 'fully up' or 'fully' down, but the blind also has an intermediate position.

To operate, pull down by holding the fingergrip(s), gently ease towards the window to locate the catches. To retract, pull down easing away from the window to release the catches and guide to the required position.

- Only operate by holding the fingergrip(s) - pulling on one side will cause uneven running and snagging.
- Do not allow the blind or flyscreen to re-coil without control.

- It is not recommended that blinds and/or flyscreens are left in the down position for long periods, or when travelling, as this can result in fatigue of the spring.
- Clean the cassette, side track and fabrics with mild detergent and water.
- Lubrication of mechanism or spring is not required or recommended.

For more detailed information, see manufacturer's instructions.

#### Cassette Blind and Flyscreen

Always hold the end rod in the middle. When closing blinds, slide the end rod of the flyscreen blind on to the end rod of the sun blind and engage. To open the blind push the end rods towards the darkening blind to the edge and disengage the end rods. Now move the end rod of the flyscreen back by hand - do not let it recoil.

#### Tensioning Seitz blinds and flyscreens

Seitz Komfortrollo window blinds/flyscreens are pre-tensioned, it may also be necessary in the future to adjust the tension of these. Remove the left hand top corner cap. Adjust the lower screw for the blind and the higher screw for the flyscreen. Care should be taken not to over tighten the springs.

The spring in the Seitz cassette window blinds/flyscreens are pre-tensioned. However, it may be necessary in the future to adjust the tension. The tensioning screw is positioned on the right

hand top corner of the cassette. Firstly remove the plug then adjust by rotating the screw clockwise. Then replace plug.

The blinds should rewind without stopping or moving in a sluggish manner.

### OPERATING INSTRUCTIONS FOR BLINDS

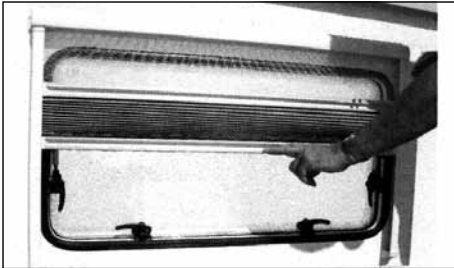

**Closing:** Grab the end bar in the middle and push the blind and flynet together or singly (blind - lower end bar) downwards until the required position is reached.

**Opening:** Push the end bar of the flynet and / or of the blind upwards.

**Care instructions:** Clean the blind only with a damp sponge. Clean on a regular basis to avoid dirt particle build up as this can damage the blind material. Use only water or with mild suds or a vacuum cleaner.

In order to avoid material fatigue, do not leave the flynet closed for a long time.

### WINDOWS/ ROLLER BLIND ADVICE

In case of prolonged exposure to the sun roller blinds should not be completely closed as this could cause excessive heat concentration at the top of the window, due to characteristics of the glazing material the windows could be adversely affected.

Roller blinds that shade from the bottom upwards it is necessary to leave a gap of a few centimetres open at the top, this way the heat between window and blind can escape. A fly screen does not cause an obstruction.

Roller blinds that shade from the top downwards must be kept completely open, or be opened regularly to allow the heat to escape.

Keeping the windows in ventilation position allows heat to escape.

Never fully close a roller blind system when storing the vehicle or when not in use for longer periods!

Therefore for optimal window life it is recommended:-

- Blinds starting at the bottom of the window a gap should be provided for ventilation at the

top with the window in its ventilation position.

- For vehicles containing blinds from the top downwards or with other types of reflective blinds / curtains, please make sure that these blinds are also ventilated or not fully closed.

Ensure that all windows and roof vents are closed when the vehicle travels on the road.

### ROOF LIGHTS

When opening the roof lights, care must be taken to release the locking mechanism as the unit is raised.

Roof lights must be fully closed when driving. Roof lights provide essential fixed levels of ventilation.



#### Mini Heki Rooflight

To open depress button and push bar upwards. The rooflight has two open ventilation positions and a fully open position.

The blind and flynet operate independently of

## Equipment details

each other and are engaged by connecting to each other and sliding.

**Heki care instructions:** Clean the blind only with a damp sponge. Clean on a regular basis to avoid dust/ dirt particle build up as this can damage the blind material. Use only water or with mild suds or a vacuum cleaner.

In order to avoid material fatigue, do not leave the flynet closed for a long time.

### Midi Heki Roof-light



**With operating bar:** To open, depress button and push bar to required position. The rooflight has two open ventilation positions and a fully open position.

To close, reverse the operation and then check if locked into position.



**With crank:** To open, rotate the crank until a resistance is noticeable during the operation.

To close, reverse the operation and then check if locked into position.



**Electric version:** To open, push button until desired position is reached or the electric motor switches off.

To close, reverse the operation and then check if locked into position.

## SKYVIEW OPERATING INSTRUCTIONS

### Safety and care instructions

**Before opening the dome please check if all handles are disengaged and no objects are in the opening area of the rooflight.**

To open, turn the handle anti-clockwise to the required opening position.

## Equipment details



To close, turn the handle clockwise until the dome lies on the seal and a resistance is noticeable.

**Before you start your journey, close the rooflight by turning the handle to the closed position**

Please make sure that no persons or objects are in the closing area of the rooflight.



Do not leave the vehicle with the roof light open (danger of burglary and water penetration).

Do not open in strong wind, rain or snowfall. Before opening, remove snow, ice, dirt etc. from the dome.

Malfunctions must be repaired by an approved dealer at once. Do not use caustic detergents (danger of tension cracks in the dome).

Before setting off close the dome and check the locking mechanism.

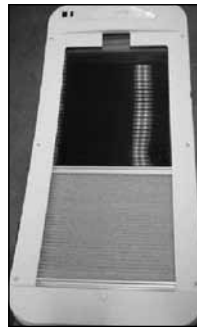

### Opening/closing the blind and fly net

Pull the end rod from the recessed part and push it in a position you desire. You can adjust the incidence of light with the second operating bar.

### Safety precautions

Repairs should be carried out only by trained personnel. Inform an approved dealer in case

of defects and malfunctions.

Before starting off, check the roof light for damage in the dome (tension cracks) and the opening mechanism which could arise owing to, for example, branches and other natural causes. Do not step on the screen.

## Equipment details

Avoid high speed (maximum speed recommended is 130 km/h). Do not close the blind more than 2/3 during the day (danger of heat build up). Before starting off, Open the blind.

### Care instructions

Clean the dome with the Seitz acrylic cleaner.

Opaque spots and light scratches on the dome can be removed with the Seitz Acrylic Polish and the Seitz Special Polishing cloth.

Use talcum powder regularly (4 times yearly) to care for the rubber seals.

Clean the blinds only with water and mild soap suds or a vacuum cleaner.

**The guarantee becomes null and void if the care and safety instructions are not followed.**

## BLIND AND FLYSCREEN



The blind and flyscreen operate Independently of each other and are engaged by connecting to each other and sliding.

### Safety precautions:

1. Repairs should be carried out only by trained personnel.
2. Inform an approved dealer in case of defects and malfunctions.
3. Before starting off, check the rooflight for damage in the acrylic dome (tension cracks) and the winding mechanism which could arise owing to, for example, branches and other natural causes.
4. Do not step in the acrylic dome.
5. Close the roof light before starting off (check whether it is locked).

6. Do not leave the vehicle with the rooflight open (danger of burglary or from rain).
7. Do not open in strong wind or rain.
8. Before opening, remove snow, ice, dirt, etc. from the acrylic dome.
9. Malfunctions are to be repaired by an approved dealer at once.
10. Do not use caustic detergents (danger of tension cracks in the acrylic dome).
11. Do not operate whilst the vehicle is moving.

### Care instructions:

- Please clean the acrylic panes with the Seitz Acrylic Cleaner.
- Stains and light scratches on the acrylic pane can be removed by using the Seitz Acrylic Polish and the Seitz special polishing cloth.
- Use talcum powder (4 times yearly) to care for the rubber seals
- Clean the blinds only with water and mild soap suds
- The guarantee becomes null and void if these instructions are not followed.



### SEAT SWIVEL (DRIVER/PASSENGER)



To turn the swivel, slide the BLACK lever rearwards and adjust to the required angle. Before driving off ensure the locking mechanism is fully secure.

### SIDE LOCKERS



Some models are provided with exterior access locker doors. These are suitable for storing external equipment.

### BUNK AND LUTON BED SAFETY

Where the sleeping surface is over one metre above floor level the following notices apply.

**WARNING: Always ensure safety boards are located before entering the bunk.**

**WARNING: Use upper bunks for sleeping only, with the provided protection against fall out in position.**

**WARNING: Care shall be taken against the risk of fall out when the upper bunks are being used by children, especially under 6 years of age, these bunks are not suitable for use by infants without supervision.**

Layouts with an over-cab bed (luton bed), access may be restricted when the lower bed (model specific) is fully extended at night time.

### FURNITURE DOORS

During normal travelling, vehicle vibration and flexing may cause some of the furniture doors to become out of alignment. For your convenience many hinges are adjustable.

### ASH FRAMED DOORS

In order to provide customers with the latest designs of door furniture it is possible, due to the use of natural wood, that warping may occur. This should not detract from the correct functioning of items fitted in the vehicle.

### TABLES

Note: The free standing table legs have a positive locking mechanism. Care must be taken to ensure that, when folded, the leg which is closed first locks into the second position.

When engaging legs in down position the mechanism must be positively locked down.

**CAUTION! When erecting the free standing table, be careful to avoid trapping fingers.**

## Equipment details



### TABLE STORAGE

Tables stored in the table storage compartment must be securely clipped into place whilst in transit.

To avoid damage care must be taken when removing tables from their stored position.

### CARE OF LAMINATE TOPS, TABLES, FURNITURE AND DOORS

DO NOT use abrasives, chemically treated cloths or aggressive detergents as these may cause damage.

DO NOT place hot objects on laminated surfaces i.e. tops, tables. Any temperatures 70°C and over will cause permanent damage.

Clean worktop surfaces, furniture and door fascias with a soft, slightly damp cloth, dry off with a soft cloth.



### SHOWER

When using the shower, always ensure that the shower door is fully closed thus avoiding water spray on unprotected areas.

### 12V READING LAMP

**Warning: 12v reading/spotlamps generate high temperatures when in use, the body, lens/bulb may become very hot.**

**Never make directional adjustment in the direction of flammable materials i.E. Curtains, nets or blinds.**

### OMNISTEP SINGLE STEP

#### Operation

The OMNISTEP is operated by the lever switch.

Important: when extending the step, hold the switch until the step is completely extended. Never mount the step if retracted or if not fully extended, because then the blocking is not working and the motor can be damaged.

Check if the step is retracted before departure.

#### Maintenance

Dirt and frost can prevent the step from operating properly. In this case the moving parts should be cleaned or defrosted.

All points of movement are layered in maintenance-free bearings.

#### In case of electrical failure

If the step does not retract by motor: Loosen

the square connection according to fig. 5 (actions 1, 2 and 3), push the footboard in (4) and tie it to the frame.

### Current drawn

5 A. When fully extended or retracted: 14-18 A

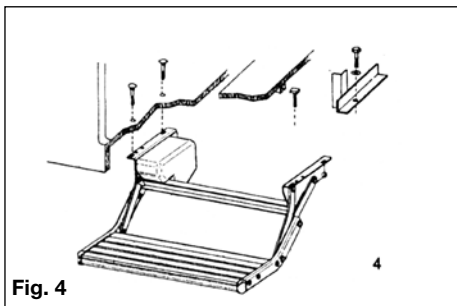

Fig. 4

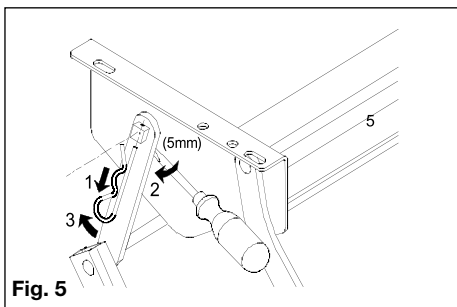

Fig. 5

## OMNISTEP SLIDE-OUT STEP

### Operation

Press the “step out” key to bring the step out until it reaches the end of its run or comes up against an obstacle. The step does not come out if the the engine is running. Press the “step in” key to take the step back until it reaches the end of its run or comes up against an obstacle. The step goes back in automatically when the engine is running. In this situation the buzzer sounds until the step is fully closed.

### Maintenance

Dirt and frost can prevent the step from operating properly. In this case the rails and moving parts should be cleaned or defrosted.

### In case of electrical break down

If the step does not retract by the motor

- Remove the front plate of the step. (Fig. 1)
- Remove the connection between the footboard and the arms (with screwdriver and wrench S10). (Fig. 2)
- Slide out the footboard.
- Reinstall the front plate.

### Current drawn

- Working current: 5 A
- Blocking current, when fully extended or retracted: 14 A

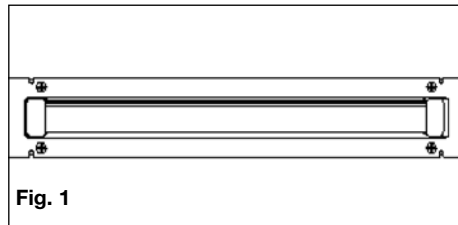

Fig. 1

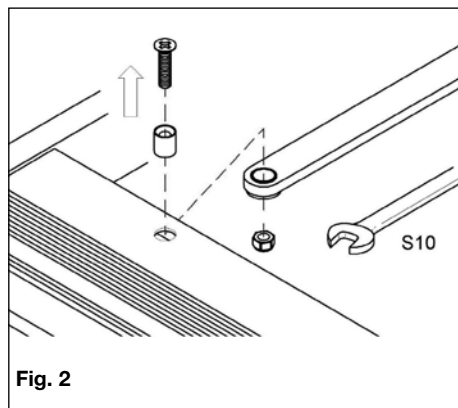

Fig. 2

# Equipment details

## OMNISTEP DOUBLE STEP

### Operation

Press the 'step out' key to bring the step out until it reaches the end of its run or comes up against an obstacle. The step does not come out if the the engine is running. Press the 'step in' key to take the step back until it reaches the end of its run or comes up against an obstacle. The step goes back in automatically when the engine is running. In this situation the buzzer sounds until the step is fully closed.

**Never mount the step if retracted or if not fully extended**

### Maintenance

Dirt and frost can prevent the step from operating properly. In this case the moving parts should be cleaned or defrosted. All points of movement are layered in maintenance-free bearings.

### In case of electrical break down

If the step does not retract by motor:

- Loosen the square connection according to fig. 2 (actions 1, 2 and 3), push the footboard in (4) and tie it to the frame (fig. 3).

Current drawn

- 7 A. When fully extended or retracted: 19 A

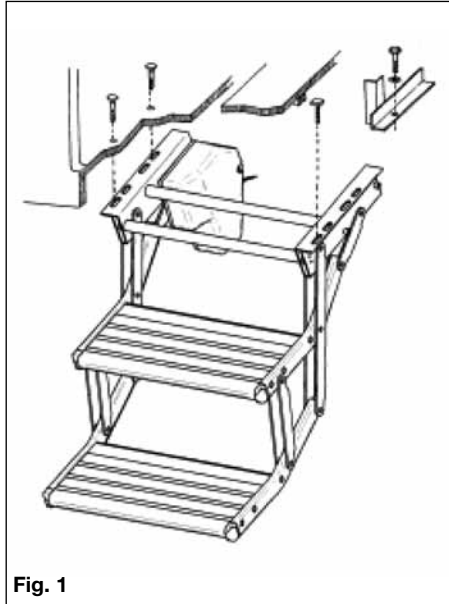

Fig. 1

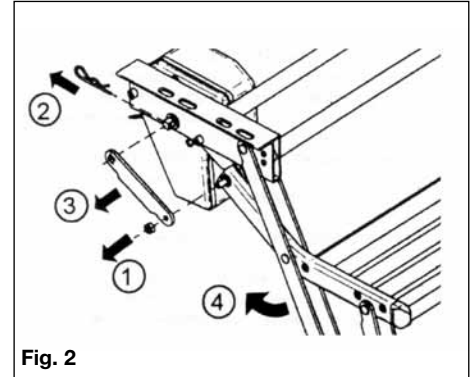

Fig. 2

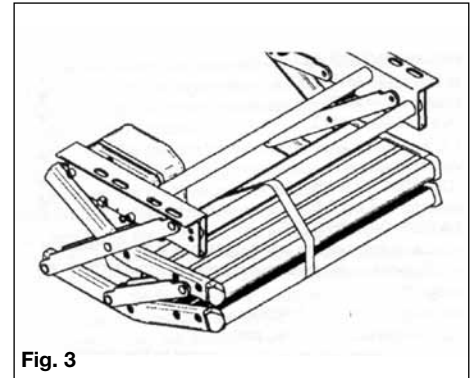

Fig. 3

## MANUALLY OPERATED ENTRANCE STEP



**WARNING:** Ensure the step is in the fully closed position before moving off, by reversing the procedure. An alarm will sound if the engine is started whilst the step is out

## FIAMMA F45I SIDE AWNING

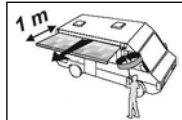

In order to avoid unnecessary strain on the awning as well as on the vehicle side, we suggest that the legs be extended about 1 m from the opening.

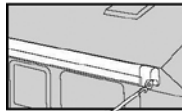

Unscrew the leg knob to slide the leg out of its seat.



Grasp the leg near its hingejoint and pull it in a horizontal direction.

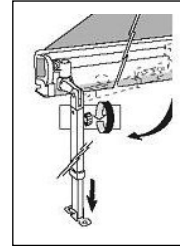

Lower the leg as shown in the figure.

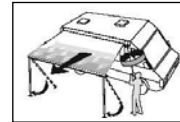

After unrolling the awning completely, adjust the legs at the chosen height.

To avoid that the awning is lifted up by an unexpected gust of wind, it is necessary to secure the legs to the ground with the provided hooks. For greater safety, we strongly advise you also use some storm cords in the upper part of each support leg or anchor the awning with the Fiamma Tie-Down Kit strap.

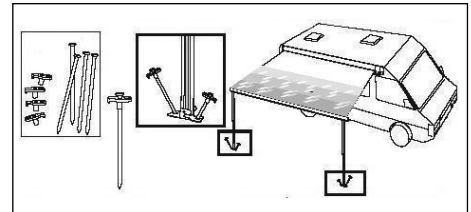

## Equipment details

If you want to fasten the support legs to the vehicle, put the terminals into the wall brackets. The brackets can be fixed only in reinforced points.

**Caution: Swift recommend that the awning be ground mounted only.**

**Side mounting brackets are supplied. But in inclement weather conditions may cause damage to the motorhome bodywork**

**Caution: The awning is a sun protection, please roll up your awning in case of rain, wind or snow.**

**Alternatively lower one side of your awning, so that water can flow away and assemble the tension rafter as shown in the figure (not included for all awning lengths).**



Make sure that the awning perfectly rolls up: when it is, the red indicators on the front profile ends are no longer visible. A damaged fabric does not allow the awning to perfectly roll up. Never use the awning with a damaged canopy. Wash the canopy with Fiamma BRILL.

**NOTE: In case of problems refer to the user manual or contact your dealer.**

### Suggestions for use and maintenance for the fabric of your awning

Fiamma fabrics are made with PVC and Polyester layers and their properties can change in certain weather conditions.

For example, if you close the awning which has been opened in the sun for a long time, wrinkles can appear on the fabric.

In low temperature, the fabric becomes less pliable and there is a risk of cracks.

Please find here a list of some practical advice for the best and long lasting use of your awning:

1. Open and close the awning in normal condition of dampness and temperature (at night or in the morning) making sure the fabric has no sharp objects on it and is clean.
2. When closing the awning after a long period in the sun, wrinkles may appear and prevent the awning closing completely. In this case the security of the awning is not compromised, as the security winch will

prevent accidental opening. If wrinkles appear re-open the awning and leave in the sun for some hours and the folds will disappear. Then of course you need to re-close the awning in normal conditions (see point 1).

3. Residual damp can cause spots on the fabric. If the awning has to be closed when the fabric is damp we suggest you re-open it as soon as possible to dry.
4. We suggest you avoid using the awning below freezing 0°C.
5. When closing the awning you should support the front bar.
6. Most of the dirt seen on the fabric will be superficial and can be cleaned with water and a cloth. Stubborn marks can be removed using a light detergent. Please do not use aggressive chemical substances and do not use high pressure cleaning tools.

## FIAMMA F65 ROOF MOUNTED AWNING

**BEFORE USING YOUR F65 ROOF MOUNTED AWNING FULLY READ THE FIAMMA USER INSTRUCTIONS SUPPLIED WITH YOUR MOTORHOME (THE FOLLOWING IS A GUIDE ONLY)**

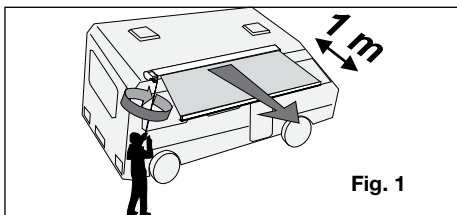

In order to avoid an unnecessary effort on the awning, we suggest the legs are located to the ground after 1m the canopy is extended. According to the further unrolling the legs should be moved forwards to assure a continuous support of the awning.

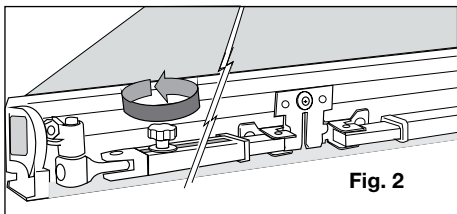

Unscrew the leg to allow its sliding out of the front profile.

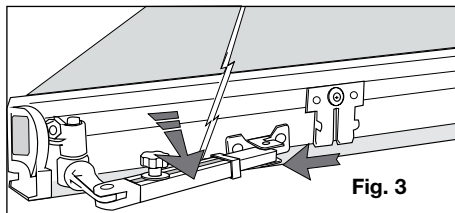

Take the leg near its hinge-joint and pull it in a horizontal direction.

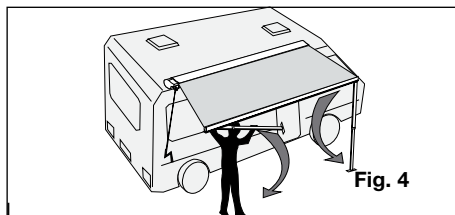

By this action the hinge will come out of the front profile and the leg will slide out and swing downwards.

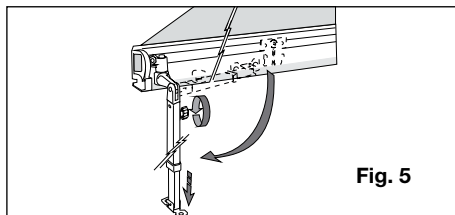

After unrolling the awning completely, fix the legs at the chosen height.

## Equipment details

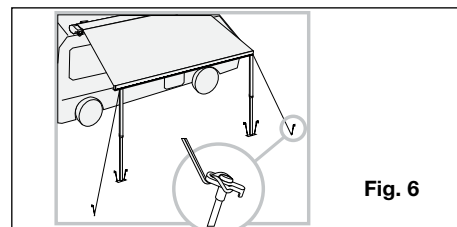
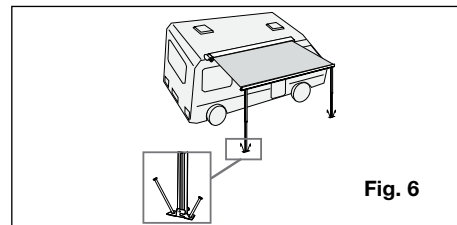

To avoid that the awning could be taken up by a sudden wind, causing a possible damage to the vehicle by the swinging of the legs, it is necessary to secure the legs to the ground with the provided hooks. As a supplementary security, we strongly advise to make use of a storm cord at the upper side of each support leg or to anchor the awning with the Fiamma Tie-Down Kit strap.

## Equipment details

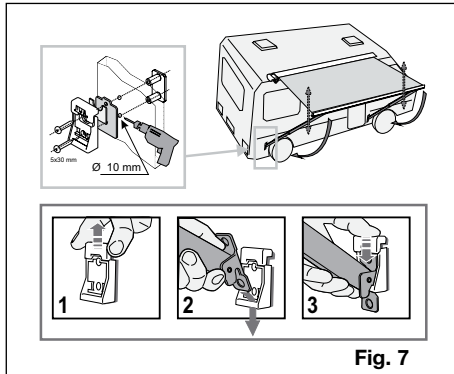

The support legs can also be fixed to the wall brackets. The wall brackets can be fixed only in reinforced points.

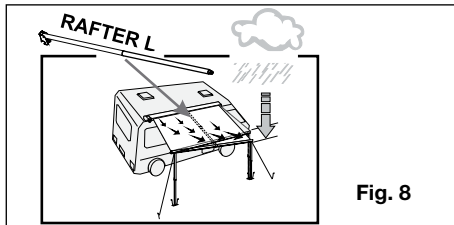

We remind you that the awning is a sun protection, so please roll up your awning in case of rain, wind or snow. Otherwise, please take following precautions: Lower one side of your awning, so that water can flow away and use

the tension rafter (not included for all awning lengths).

Make sure that the awning can be correctly rolled up. A damaged fabric does not allow a correct rolling up of the awning. Never use the awning with damaged canopy. Wash the canopy with Fiamma BRILL. In case of problems, please contact your nearest dealer.

## STATUS 530 DIRECTIONAL TV AND FM RADIO ANTENNA

(model dependant )

Firstly determine the approximate location of the nearest transmitter and whether the signals are horizontally or vertically polarized. For assistance ask your site operator or check antennas in the vicinity

1. Loosen the Mast Locking Collar and Wall Bracket and raise the antenna. Turn the mast to direct the Antenna towards the TV transmitter.

The RED spot on the bottom of the mast indicates the front of the Antenna.

2. When receiving vertically polarized signals, rotate the winder anti-clockwise to cant the antenna through 90°.

DO NOT over tighten or use undue force on the winder.

DO NOT cant for vertically polarized signals with the TELESCOPICS EXTENDED

3. Switch ON the Power Pack and the RED LED will illuminate.
4. Check the gain control switch is set to normal – NML.
5. Tune your television to the strongest signal. You may need to adjust the direction of the mast to achieve the best quality picture.



- Secure by tightening the Mast Locking Collar and Wall Bracket

## Removing the antenna

A permanently fitted Status can be easily removed leaving only the Mounting Foot and rubber gaiter.

- Unplug the antenna from the Power Pack.
- Loosen the Mast Locking Collar and Wall Bracket and lift off whilst feeding out the cable.
- Push the Blanking Cap supplied into place.

**IMPORTANT** – The Blanking Cap is a temporary seal and is not for long term use.

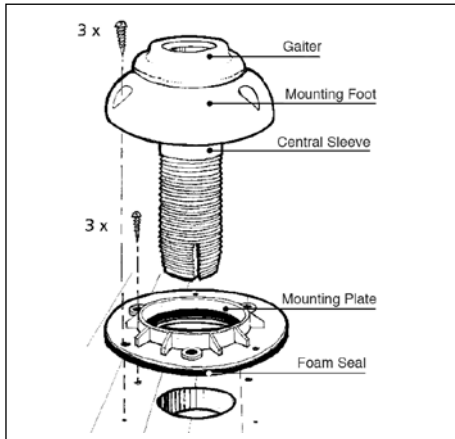

## CD/MP3 PLAYER

Please refer to the separate instructions supplied with the head unit for details of its operation.

## REVERSE CAMERA FUNCTION

On vehicles fitted with a split rear view mirror, the reverse camera image is displayed constantly, when the ignition is on, even if the vehicle is in a forward gear. The image can be turned off, by switching off the mirror unit.

## LCD TV/DVD/CD/MP3/DVB unit

Please refer to the separate instructions supplied with the unit for details of its operation.

With regard to Freeview TV and radio reception, please note that the number of channels available will vary according to the area, and also on the signal strength available at the location. Please ensure that the fitted directional aerial is switched on, and raised and directed toward the nearest transmitter before scanning for channels.

**It is illegal for the monitor to be used whilst travelling in the forward direction.**

## MOTORHOMES WITH EXTERNAL CO-AX CONNECTION

Depending on specification, the motorhome may be fitted with an external co-ax connection in place of, or in addition to, a roof mounted TV aerial. The external co-ax connection point will be within the battery box (Escape models) or the mains inlet enclosure (Bolero, E500 series).

### Co-ax connection within battery box

Within the battery box a White cover flap conceals a push-on type co-ax connection. A co-ax cable is fitted and connected within the motorhome from the back of this connection to the TV position within the motorhome.

An external TV aerial or site TV feed can be connected to the external connection point; signals from that connection will then be available at the TV position co-ax socket within the motorhome.

### Co-ax connection point within the mains inlet enclosure

A short co-ax lead featuring a screw on co-ax connection will be present behind the Blue mains inlet connector. A co-ax cable will be fitted and connected within the motorhome, from the back of this connection, to the primary TV position within the motorhome. At the same time, further co-ax cable or cables will be fitted which route from a likely TV aerial position

## Equipment details

(i.e. within the wardrobe) to each of the TV positions within the motorhomes.

The primary TV position will feature a socket marked 12v, TV, and SAT. The co-ax from the external connection point will route to the socket output marked SAT, whilst the co-ax from the wardrobe or similar will route to the socket output marked TV. At any secondary TV positions, if present, the co-ax from the wardrobe will route to the socket output marked TV.

An external TV aerial or site TV feed can be connected to the external connection point; signals from that connection will then be available at the primary TV position within the motorhome. As the connections are of the screw-on type, it is also possible to use this co-ax to route from an externally mounted satellite dish, to a satellite receiver.

# MOTORHOME CARE

<b>Modifications - DIY work</b> .....	160
<b>Exterior</b> .....	160
<b>Condensation</b> .....	160
<b>Interior</b> .....	162
<b>Winterisation/storage</b> .....	163
<b>Chassis and rear axle</b> .....	165
<b>AL-KO exhaust system</b> .....	165
<b>Caring for the environment</b> .....	165

# Motorhome Care

## MODIFICATIONS - DIY WORK

Owners need to be aware that carrying out DIY modifications to your motorhome may in certain instances, invalidate the warranty cover and could also affect the safety and structure of the vehicle.

### **WD40 IS NOT RECOMMENDED FOR EXTERNAL OR INTERNAL USE**

WD40 attacks paintwork and sealants. If a lubricant is required for Interior hinges, Sliding door tracks, Bottle box hinges, Exterior door hinges, Plastic tracking etc. We recommend "Ambersil 40+" this is readily available from most DIY/Automotive retailers including Halford's

Before carrying out any DIY work within the warranty period, please check with your nearest Swift Group dealer for advice.

## EXTERIOR

### **Aluminium Panels**

The stove enamelled paintwork is very durable and easy to clean owing to the high gloss properties.

### **Plastic Panels (GRP/ABS)**

These are used for front and rear panels and, in some cases for the roof.

## Cleaning

For both aluminium panels and plastic panels.

1. Wash the vehicle regularly with mild detergent. Rinse with cold water and leather off.
2. For better protection a similar coloured good quality car wax may be applied.

When cleaning sealant sealed areas, use Domestos/water.

**WARNING: Under no circumstances use any abrasive cleaning agents or solvents on the exterior panels.**

**Care should be taken as the silicon in some polishes can attack the rubber used on the exterior for seals and gaskets.**

## Mouldings

All mouldings are anodised aluminium and will retain their lustre for a long period if no abrasive materials are used on them. If your motor home is subject to constant changes in temperature, mastic may seep from the joints between the mouldings. Excess mastic that appears can be removed by wiping with a soft cloth.

## Acrylic Windows

The windows in your motorhome are fully double glazed and, with care, will remain sparkling and scratch free.

## CONDENSATION

### **What is condensation?**

Condensation is the change of water from its gaseous form (water vapour) into liquid water. Condensation generally occurs in the atmosphere when warm air rises, cools and loses its capacity to hold water vapour.

As a result, excess water vapour condenses to form droplets.

### **Why condensation occurs**

Condensation occurs when warm moist air meets a cold surface. The risk of condensation therefore depends upon how moist the air is and how cold the surfaces of the vehicle are. Both of these depend to some extent on how the vehicle is used. In a Caravan or Motorhome with a cold outside wall, if the temperature of the wall falls below the dew point temperature, it is quite normal for condensation to occur predominantly on the external walls.

### **When condensation occurs**

Condensation occurs usually in winter, because the Caravan or Motorhome is cold and because skylights, windows and doors are opened less and therefore the moist air cannot escape.

### **How condensation occurs**

Condensation occurs often for short periods in bathroom and kitchen areas because of the steamy atmosphere, and quite frequently for long periods in unheated areas; it also occurs in cupboards or corners of rooms where

ventilation and movement of air is restricted.

## What is important

Two things are particularly important:

- To provide ventilation so that moist air can escape.
- To use the heating reasonably.

## How can you prevent condensation

Provide ventilation so that moist air can escape.

- a) Good ventilation of kitchens when washing, cooking or drying damp clothes is essential. Use the electric element of the space heater will help, when washing, cooking, or drying damp clothes, and particularly when the windows show signs of misting up.
- b) If there is no mains electric supply and therefore you cannot use the electrical element of the space heater, open the skylights or windows slightly, but keep the door closed as much as possible.
- c) After showering, keep the bathroom window or skylights open, and shut the bathroom door long enough to dry off the room.
- d) In all other areas provide some ventilation. Fixed ventilation is provided in accordance with BS EN 721: 1998 this is through skylights and 'heki roof lights' in the roofs and from ventilators through the floor under cookers, motorhome step well, doors and in bed boxes it is important not to block these.

Too much ventilation in cold weather is uncomfortable and wastes heat. All that is needed is a very slightly opened window or skylights. Opening a skylight or 'Heki; rooflights partially or windows opened to about 1cm opening will usually be sufficient.

## Provide reasonable heating

- a) Do not use portable paraffin or flueless gas heaters at all.
- b) If drying damp clothes or towels, open a window enough to ventilate the area and turn on the electric element of the space heater but do not hang items over the heater.
- c) Try to make sure that all areas are at least partially heated. Condensation most often occurs in unheated areas.
- d) To prevent condensation, the heat has to keep room surfaces reasonably warm. It can take a long time for a cold Motorhome to warm up, so it is better to have a small amount of heat for a long period than a lot of heat for a short time.
- e) Motorhomes are left unoccupied and unheated and can get very cold. Whenever possible, it is best to put the heating on at a low level before setting off on a journey in the winter to pre heat the vehicle.
- f) In houses, the rooms above a heated room benefit to some extent from heat rising

through the floor. In Motorhomes this does not happen.

Motorhomes use only carefully selected insulation materials but unlike most rooms at home they have all outside walls, so they lose heat through all walls as well as the roof and floor.

Even in a well insulated motorhome with reasonable ventilation it is likely during cold weather if the temperature is less than 10°C that condensation will occur. Ideally the temperature should be kept about 20°C although this is not always possible.

## Mould growth

Any sign of mould growth is an indication of the presence of moisture and if caused by condensation gives warning that heating or ventilation, may require improving.

## New vehicles

New Motorhomes often take a long time before they are fully 'dried out' because of moisture in the materials used in the manufacture. While this is happening they need extra heat and ventilation. At least during the first winter trips and may require more heat than they will need in subsequent winters journeys. Allowance should be made for this.

**WARNING: Do not wash your Motorhome with a high pressure washer as these can permanently damage the seals of your vehicle.**

# Motorhome Care

## Changing Exterior Bulbs ALWAYS REPLACE LIKE FOR LIKE

For individual replacement bulb specification, refer to your Specification Handbook.

Generally road lighting bulbs can be easily replaced by unscrewing and removing the lens from the exterior of the caravan or motorhome.

## INTERIOR

Follow these guidelines to ensure your investment is receiving the very best attention.

### Windows/ Roller Blind

In case of prolonged exposure to the sun roller blinds should not be completely closed as this could cause excessive heat concentration at the top of the window, due to characteristics of the glazing material the windows could be adversely affected.

Roller blinds that shade from the bottom upwards it is necessary to leave a gap of a few centimetres open at the top, this way the heat between window and blind can escape. A fly screen does not cause an obstruction.

Roller blinds that shade from the top downwards must be kept completely open, or be opened regularly to allow the heat to escape.

Keeping the windows in ventilation position allows heat to escape. Never fully close a roller blind system when storing the vehicle or when

not in use for longer periods!

Therefore for optimal window life it is recommended blinds starting at the bottom of the window a gap should be provided for ventilation at the top with the window in its ventilation position.

For vehicles containing blinds from the top downwards or with other types of reflective blinds / curtains, please make sure that these blinds are also ventilated or not fully closed.

Ensure that all windows and roof vents are closed when the vehicle travels on the road.

### Side Walls, Roof Lining

A simple wipe over with a damp cloth and a very mild detergent is all that is needed.

### Soft Furnishings

Should be vacuumed occasionally to remove grit and sand and help to keep its smart appearance and ensure long life. The upholstery can be cleaned with a mild, reputable upholstery cleaner. It is recommended that the curtains and pelmets are specialist cleaned only. The foam used in cushions are manufactured to meet fire regulations. It requires time to return to its normal position after prolonged use.

Clean and dust the upholstery and if possible remove before placing the Motorhome into winter storage. Alternatively, stand the cushions on their edges to allow circulation of air. This

will reduce the possibility of dampness from condensation. Keep curtains or blinds closed, to minimise fading of furniture.

If the blinds and/or flyscreens remain down for a prolonged period of time, re-tensioning of the springs will be necessary before re-use.

### Work Surfaces

You should not stand very hot items on any of the work surfaces.

### Cupboard Catches

It is advisable to lightly oil all cupboard catches, sliding bolts and hinges from time to time.

### Bathroom, Shower Room and Kitchen Equipment

All the Thermoplastic parts in these areas have easy clean surfaces. To ensure long life and prevent damage you must not use any cleaning materials at all and ensure water temperatures do not exceed 70°C, (putting cold water in first is suggested). After every use, it is essential that you rinse with clean water only and wipe with a soft damp cloth.

Failure to follow these simple instructions may result in premature failure or cracking which will not be covered by any guarantees (including extended warranties).

### Furniture

A simple wipe over with a damp cloth should be all that is required. Polishing with a proprietary brand of wax polish enhances and

maintains furniture in showroom condition.

It must be remembered that because the frames of some doors are made of ash, which is a natural product, they can be affected by temperature and humidity and may bow under certain conditions. As conditions change they should revert to their original positions.

### **Kitchen Drainer and Cutting Board**

You should not stand hot items on to these items. To wash use only warm soapy water, do not use chemicals and bleach.

### **Changing Interior Bulbs**

Remove the lens or lamp shade to access the bulb.

### **ALWAYS REPLACE LIKE FOR LIKE**

For individual replacement bulb specification, refer to your Specification Handbook.

## **WINTERISATION/STORAGE**

This is probably an opportune moment to arrange for the Motorhome to have its annual service at your appointed dealer.

The following applies whenever your Motorhome is stored particularly during the winter months.

Do not park near trees or larch type fences, due to possible wind damage.

Keep any grass around the floor of the

Motorhome short, to maintain air flow and stop any possible damp getting into the Motorhome.

It is advised that the Motorhome is ventilated regularly throughout the winterisation /storage period, opening windows, doors and rooflights when possible.

### **General**

**For care of the vehicle battery please refer to the Fiat/Peugeot handbook in section 'Correct use of the vehicle' particularly 'Vehicle inactivity'.**

All moving parts should be checked for free operation.

Clean all cooking appliances and refrigerator. Lubrication should be carried out at the points illustrated in the general notes on chassis maintenance.

Charge up the on-board battery every 2 months.

Leave the refrigerator door open. Leave furniture doors and lockers open to allow air to circulate fully.

### **Soft Furnishings**

Clean and dust the upholstery and if possible remove before placing the Caravan or Motorhome into winter storage. Alternatively, stand the cushions on their edges to allow circulation of air.

This will reduce the possibility of dampness from condensation.

Keep curtains or blinds closed, to minimise fading of furniture.

If the blinds and/or flyscreens remain down for a prolonged period of time, re-tensioning of the springs will be necessary before re-use.

### **Wheels and Tyres**

Do not store in one position with partially deflated tyres. The tyre walls will suffer and do present a real danger of blow outs, especially when travelling at faster speeds than are allowed in the UK.

The wheels should be turned every couple of weeks. If you are removing the wheels, follow the jacking procedure for changing a wheel. Check your tyres regularly for signs of age and deterioration, particularly wear, cracking and blistering. If in doubt consult a reputable tyre fitter.

### **Water System**

Remove chopping board from bowl. All taps should be opened. Single lever mixer taps, including the shower mixer, should have the lever moved to the central position and lifted to the open position for hot and cold.

**Drain water heater:** Open yellow handle on in line valve normally adjacent to water heater. Valve is open when handle is vertical.

**Drain water tanks:** Fresh tank: either remove the water dump plug in the base of the tank accessible via the cleaning hatch or by the drain tap situated below the skirt panel

# Motorhome Care

(model specific).

Waste tank: open in line valve adjacent to the tank. Valve is open when handle is in line with body of valve.

With valves and switches set as previously described to run taps from the fresh water tank, the pump can be run momentarily to assist purging the water tank and pipes.

Remove shower head. Let the shower hose drain into the shower tray and then return to holder.

The Motorhome may be left in this condition over winter or until ready to use. It is recommended to leave the drain taps in an open position during storage. Before recommissioning the system, reverse all above actions.

Before recommissioning the system, reverse all above actions.

The Thetford Cassette toilet is easily winterised for storage.

Empty remaining fresh water into the bowl by activating the flush handle up and down or by pressing the flush button (model dependant).

Once pump has been cleared and water flow has stopped completely, release into waste tank. Remove waste tank and empty contents in normal way.

To evacuate any remaining water from the fresh water tank, place a container underneath the drainplug and remove drainplug.

When the procedure has been completed replace drainplug and waste holding tank. Clean the seals and grease them if necessary after drying, with acid free vaseline.

Leave the blade of the holding tank open.

Do not replace cap on the pour out spout, to ventilate the holding tank.

## Recomissioning the Water System

Fill the fresh water tank on the Thetford Cassette porta potti (model specific) using a hose or jerrycan until the water in the funnel reaches the neck. Tank capacity is 15 litres. Aqua Rinse may be added to improve cleaning of bowl and flushing of unit.

Replace cap. Swing back the water fill funnel until it touches the water tank.

Add Aqua Kem (100 ml) into the Cassette (or 120 ml if using Aqua Kem Bio) through the pour out spout. Add small amount of water through the pour out spout and replace the cap. Close the cold taps and ensure all the drain taps are closed.

It is advisable after storage to flush the water system initially with a sterilising agent (such as Milton), and then with water repeating until the system is well flushed through.

Connect the pump.

Fill the system with water until water flows freely from the hot taps. About 2 gallons of water will be required. Close the hot taps.

## Appliances

Before starting motor caravanning after storage, check all gas appliances and electrical points.

Note: Preferably not less than once a year, the electrical installation should be inspected and tested by a qualified electrician.

After storage it is advisable to air the Motorhome and clean throughout, especially cooking appliances and the refrigerator.

Replace the bedding if they were removed for storage.

**Important: Always follow the manufacturers recommended procedures after use of fitted equipment in the Motorhome, before storing for any length of time.**



## **CHASSIS AND REAR AXLE**

Some models are built on Fiat/Peugeot base vehicles, the chassis of which has been converted by AL-KO. This conversion provides a hot dipped galvanised steel chassis coupled with a wide track rear axle utilising steel torsion bar suspension, imparting vastly improved stability and road holding.

## **AL-KO EXHAUST SYSTEM**

A standard Fiat/Peugeot exhaust system is fitted, utilising an AL-KO modified tail pipe, available through your approved dealer. A standard Fiat/Peugeot exhaust system is fitted to all other models, with the addition of a Swift Group tail pipe.

## **CARING FOR THE ENVIRONMENT**

After many years of service you may decide that your motorhome has become beyond economic repair and should be disposed of. Please ensure that you comply with the end of life vehicle legislation and take it to an authorised treatment facility where it will be properly dealt with to minimise any negative environmental impact. The transaction will be logged at the DVLA, identifying that you are no longer the owner of the vehicle.



# USEFUL INFORMATION

<b>Owners club &amp; aftercare .....</b>	<b>168</b>
<b>Useful contacts.....</b>	<b>169</b>
<b>Change of ownership.....</b>	<b>173</b>

## Useful information

### **OWNERS CLUB & AFTERCARE**

#### **OWNERS CLUB**

The Owners Club is a completely independent organisation run for the benefit of the motorhome owners. They have numerous rallies during the year in various parts of the country and every third year there is a 'Works Rally' where owners have the opportunity to visit the factory. Apart from the friendliness and companionship the Club generates it is also actively engaged in charity work for those less fortunate than ourselves. The address of the Secretary of the Owners Club can be obtained from Supercare (SML Ltd), Tel: 01482 875740 or from the Swift Group website.

#### **SPARES AND AFTER SALES SUPERCARE**

There are numerous items available from your dealer ranging from door catches through to spare wheels and touch-up paints. Please note that all after sales enquiries must be directed through your supplying dealer. The after sales service at the factory is geared to support our dealer network as is the service provided by appliance manufacturers.

In the interest of safety, replacement parts for an appliance shall conform to the appliance manufacturer's specifications and should be fitted by them or their authorised agents.

**Note: Please remember to quote chassis number when ordering any items from your dealer.**

#### **REPAIR FACILITIES**

Should you be unfortunate enough to suffer a major accident with your motorhome it is comforting to know that we have a completely separate repair shop facility where their fully trained experts will undertake all types of major damage repair work.

Repairs of a minor nature should be referred first to your local dealer.

### USEFUL CONTACTS

The enjoyment of your motorhome can be greatly enhanced by membership of one or more of the various caravanning, motoring and holiday clubs. Here are some useful addresses:

#### CARAVAN CLUBS

##### **The Caravan Club,**

East Grinstead House,  
East Grinstead  
West Sussex, RH19 IUA

Tel: 01342 326944  
[www.caravanclub.co.uk](http://www.caravanclub.co.uk)

##### **The Camping and Caravanning Club,**

Greenfields House,  
Westwood Way,  
Coventry,  
West Midlands.

Tel: 0845 130 7631  
[www.campingandcaravanningclub.co.uk](http://www.campingandcaravanningclub.co.uk)

### MOTORING ASSOCIATIONS

#### **Automobile Association (AA)**

Fanum House,  
Basingstoke,  
Hants. RG1 2EA

Tel: 0990 448866  
[www.theaa.co.uk](http://www.theaa.co.uk)  
email: [customer.services@theaa.com](mailto:customer.services@theaa.com)

#### **RAC Motoring Services**

RAC House,  
M1 Cross,  
Brent Terrace,  
London, NW2 1BX

Tel: 0990 722722  
[www.rac.co.uk](http://www.rac.co.uk)

#### **Green Flag National Breakdown**

PO Box 300,  
1, Cote Lane,  
Leeds, LS99 2LZ

Tel: 0345 670345

### TRADE ASSOCIATION

#### **National Caravan Council**

Catherine House,  
Victoria Road,  
Aldershot,  
Hampshire, GU11 1SS

Tel: 01252 318251  
[www.martex.co.uk/ncc](http://www.martex.co.uk/ncc)  
email: [mail@martex.co.uk](mailto:mail@martex.co.uk)

#### **The Society of Motor Manufacturers and Traders Limited (SMMT)**

Forbes House,  
Halkin Street,  
London SW1X 7DS

Tel: 020 7235 7000  
[www.smmt.co.uk](http://www.smmt.co.uk)

Swift Group Limited, Dunswell Road,  
Cottingham, East Yorkshire HU16 4JS.

Tel: (01482) 875740  
email: [enquiry@swiftgroup.co.uk](mailto:enquiry@swiftgroup.co.uk)  
website: [www.swiftgroup.co.uk](http://www.swiftgroup.co.uk)

© 2010 SWIFT GROUP LTD

# Index

## Symbols

12 Volt DC fuses .....62

## A

Advice on towing .....18

After sales Supercare .....168

Alarm test .....27

Alde Compact 3010 .....92

Alde Compact 3010 quick start guide.....91

AL-KO exhaust system .....165

Annual service / inspection record .....6

Annual service / inspection record Stamps.....7

Ash framed doors .....149

Assistance .....4

## B

Battery charger .....60

Before moving off .....14

Blind and flyscreen .....148

Bunk and luton bed safety .....149

## C

Care of laminate tops, tables,  
furniture and doors .....150

Caring for the environment .....165

CD/MP3 player .....157

Change of ownership .....173

Chassis and rear axle .....165

Children .....29

Child seats.....17

Coastal code .....12

Code of conduct .....10

Condensation .....160

Control panel EC462 .....58

Control Panel EC467 .....57

Control panel operation.....59

Cooker 3 Burner + Hotplate .....122

Country code.....12

Cruise Control .....22

## D

Dedicated travelling passenger seating .....16

Dometic CK 155 cooker hood.....131

Driving licence.....18

## E

Electrical common fault table .....64

Electrical equipment power consumption.....48

Electricity.....45

En-route heating .....43

Escape paths.....29

Exterior .....160

## F

Fault finding.....52

Fiamma F45i side awning .....153

Fiamma F65 roof mounted awning .....155

Fire.....26

Fire extinguisher .....28

Flojet automatic water system pump .....108

Fresh water system.....34

Furniture doors .....149

## G

Gas .....39

Gas safety advice .....40

Gas schematic drawing with combi boiler .....38

Gas schematic drawing with water heater .....37

Generator guidelines .....67

## H

Habitation relay .....67

## I

Inboard water tanks and on-line  
water systems .....108

Index .....170

Interior.....162

## K

Komfortrollo blinds (Seitz) .....144

## L

Large storage areas.....15

LCD TV/DVD/CD/MP3/DVB .....157

Loading of vehicle.....15

## M

Manually operated entrance step .....153

Microwave oven .....132

Modifications - DIY work . . . . .	160	<b>S</b>		Three point seat belts . . . . .	17
Motorhome battery . . . . .	52	Seat swivel (Driver/Passenger) . . . . .	149	Truma Combi 4 / Combi 6 . . . . .	79
Motorhomes with external co-ax connection . . . . .	157	Security . . . . .	29	Truma S 3002 auto space heater . . . . .	75
Motorhome terms . . . . .	14	Shower . . . . .	150	Truma Ultraheat additional electric heating . . . . .	77
<b>O</b>		Side lockers . . . . .	149	Truma ultra-store water heater . . . . .	71
Omnistep double step . . . . .	152	Skyview operating instructions . . . . .	146	Types of gas . . . . .	40
Omnistep single step . . . . .	150	Smoke alarm operation . . . . .	26	Typical appliance consumption figures . . . . .	49
Omnistep slide-out step . . . . .	151	Solar panel connection . . . . .	53	Tyres . . . . .	16
Operating instructions for blinds . . . . .	145	Solar panel connection point . . . . .	53	<b>U</b>	
Overseas connection . . . . .	46	Spares . . . . .	168	Useful contacts . . . . .	169
Owners club & aftercare . . . . .	168	Spare wheel on ALKO conversion . . . . .	22	<b>V</b>	
<b>P</b>		Spare wheel removal alternative . . . . .	23	Vehicle classifications . . . . .	18
Positioning the motorhome . . . . .	32	Spare wheel removal - Fiat/Peugeot . . . . .	24	Ventilation . . . . .	29, 41
Power supply unit (PSU) EC450 . . . . .	54	SpinFlo Cooker 3 Burner . . . . .	128	VIN (Vehicle identification Number) . . . . .	29
<b>R</b>		Status 530 directional TV and FM radio antenna . . . . .	156	<b>W</b>	
Reading lamp . . . . .	150	Supplier contacts . . . . .	5	Warranty . . . . .	2
Refrigerators . . . . .	110	Swift Talk . . . . .	ii	Waste water system . . . . .	34
Repair facilities . . . . .	168	<b>T</b>		Windows . . . . .	144
Residual current device and miniature circuit breakers . . . . .	59	Tables . . . . .	149	Windows/ Roller blind advice . . . . .	145
Reverse camera function . . . . .	157	Table storage . . . . .	150	Winterisation/storage . . . . .	163
Roof lights . . . . .	145	Teb fan . . . . .	78		
Roof loading . . . . .	16	Thermal insulation and heating . . . . .	44		
		Thetford absorber refrigerators . . . . .	110		
		Thetford C-200 CW, C-200 CWE & C-200CS cassette toilet . . . . .	136		
		Thetford C250 CWE, C250S and C250CS cassette toilet . . . . .	139		
		Thetford Cassette Toilet . . . . .	135		





**CHANGE OF OWNERSHIP****NOTIFICATION OF CHANGE OF OWNERSHIP**

If you sell your motorhome, please notify the change of ownership by completing this page, detaching it and sending it to:

Swift Group Limited, Dunswell Road,  
Cottingham, East Yorkshire HU16 4JS.  
Tel: (01482) 875740

Please note that the benefit of any unexpired warranty cannot be transferred to the new owner until the change of ownership details above have been received.

**DETAILS OF MOTORHOME:**

Model: \_\_\_\_\_

Chassis No: \_\_\_\_\_

Registration No: \_\_\_\_\_

Serial No: \_\_\_\_\_

**CURRENT OWNER:**

Name: \_\_\_\_\_

Address: \_\_\_\_\_  
\_\_\_\_\_  
\_\_\_\_\_  
\_\_\_\_\_**NEW OWNER:**

Name: \_\_\_\_\_

Address: \_\_\_\_\_  
\_\_\_\_\_  
\_\_\_\_\_



