



**2021**  
**motorhomes**  
PRICE AND SPECIFICATION



**SWIFT**  
CREATING SMILES FOR LIFE

Make your staycation a  
*safe-cation*

CARAVANS • MOTORHOMES • HOLIDAY HOMES - MADE IN BRITAIN BY SWIFT



# SELECT SPECIFICATION



122



144



164

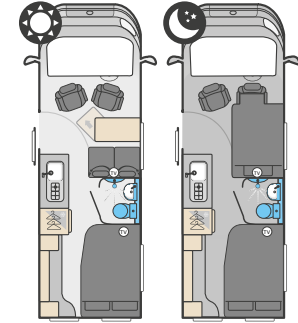
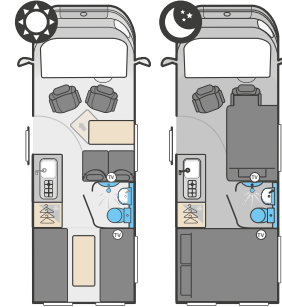
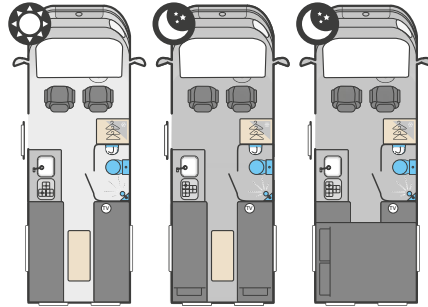

	Standard	Optional	Optional	Standard	Optional	Optional	Standard	Optional	Optional
Fiat MultiJet Diesel Engine	120	140	140 Auto	120	140	140 Auto	120	140	140 Auto
Engine Capacity	2.3 ltr			2.3 ltr			2.3 ltr		
Engine Power	120 HP @ 2750rpm	140 HP @ 3500rpm	140 HP @ 3500rpm	120 HP @ 2750rpm	140 HP @ 3500rpm	140 HP @ 3500rpm	120 HP @ 2750rpm	140 HP @ 3500rpm	140 HP @ 3500rpm
Engine Torque	320 Nm @ 1400rpm	350 Nm @ 1400rpm	350 Nm @ 1400rpm	320 Nm @ 1400rpm	350 Nm @ 1400rpm	350 Nm @ 1400rpm	320 Nm @ 1400rpm	350 Nm @ 1400rpm	350 Nm @ 1400rpm
Chassis	Panel Van			Panel Van			Panel Van		
Wheel Base	4.04m / 13'3"			4.04m / 13'3"			4.04m / 13'3"		
Seat Belts (inc. driver)	2			4			4		
Berths (Sleeping Positions)	2			3			3		
Overall Length	6.00m / 19'8"			6.00m / 19'8"			6.36m / 20'11"		
Overall Body Width (Mirrors folded)	2.26m / 7'5"			2.26m / 7'5"			2.26m / 7'5"		
Overall Height	2.72m / 8'11"			2.72m / 8'11"			2.72m / 8'11"		
Optional Awning	Thule 6300 3.5m			Thule 6300 3.5m			Thule 6300 3.5m		
Maximum Technical Permissible Laden Mass (A)	3500kg			3500kg			3500kg		
Mass in Running Order (B)	2862kg Est	2862kg Est	2895kg Est	2924kg Est	2924kg Est	2957kg Est	2974kg	2974kg	3007kg
Maximum User Payload (A-B)	638kg Est	638kg Est	605kg Est	576kg Est	576kg Est	543kg Est	526kg	526kg	493kg
Essential Habitation Equipment	0kg			0kg			0kg		
Thermal Insulation Grade	THREE			THREE			THREE		
<b>BED SIZES</b>									
Front Double									
Front Offside Single				170cm x 90cm / 54cm / 5'7" x 2'11" / 1'9"			170cm x 90cm / 54cm / 5'7" x 2'11" / 1'9"		
Rear Double	186cm x 188cm / 6'1" x 6'2"			183cm x 135cm / 6'0" x 4'5"			185cm x 130cm / 6'1" x 4'3"		
Rear Single Offside	188cm x 65cm / 6'2" x 2'2"								
Rear Single Nearside	188cm x 65cm / 6'2" x 2'2"								

174



184

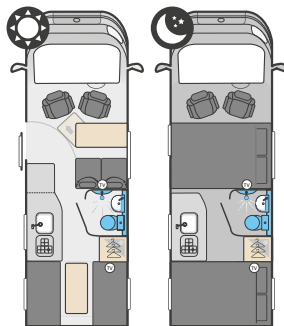
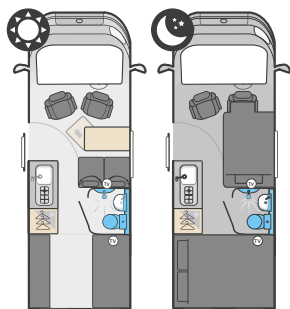

174			184		
Standard	Optional	Optional	Standard	Optional	Optional
120	140	140 Auto	120	140	140 Auto
2.3 ltr			2.3 ltr		
120 HP @ 2750rpm	140 HP @ 3500rpm	140 HP @ 3500rpm	120 HP @ 2750rpm	140 HP @ 3500rpm	140 HP @ 3500rpm
320 Nm @ 1400rpm	350 Nm @ 1400rpm	350 Nm @ 1400rpm	320 Nm @ 1400rpm	350 Nm @ 1400rpm	350 Nm @ 1400rpm
Panel Van			Panel Van		
4.04m / 13'3"			4.04m / 13'3"		
4			4		
3			4		
6.00m/19'8"			6.36m/20'11"		
2.26m / 7'5"			2.26m / 7'5"		
2.72m / 8'11"			2.72m / 8'11"		
Thule 6300 3.5m			Thule 6300 3.5m		
3500kg			3500kg		
2904kg	2904kg	2937kg	3009kg Est	3009kg Est	3042kg Est
596kg	596kg	563kg	491kg Est	491kg Est	458kg Est
0kg			0kg		
THREE			THREE		

			176cm x 122cm / 5'9" x 4'0" Est		
170cm x 90cm / 54cm / 5'7" x 2'11" / 1'9"			170cm x 90cm / 54cm / 5'7" x 2'11" / 1'9" Est		
183cm x 137cm / 6'0" x 4'6"			186cm x 120cm / 6'1" x 3'11" Est		

For General Technical Notes see back cover

## SELECT PRICES

MODEL	CHASSIS	ENGINE	BASIC PRICE	VAT @ 20%	EX WORKS	OTR PRICE
122	3500kg	120bhp	£39,404.17	£7,880.83	£47,285.00	<b>£48,780.00</b>
144	3500kg	120bhp	£40,891.67	£8,178.33	£49,070.00	<b>£50,565.00</b>
164	3500kg	120bhp	£42,345.83	£8,469.17	£50,815.00	<b>£52,310.00</b>
174	3500kg	120bhp	£40,891.67	£8,178.33	£49,070.00	<b>£50,565.00</b>
184	3500kg	120bhp	£42,345.83	£8,469.17	£50,815.00	<b>£52,310.00</b>

OTR = On the Road.

## OPTIONAL EXTRAS

FACTORY FIT	PRICE	WEIGHT
The following prices are for optional extras fitted at the time of manufacture of the motorhome (Subject to availability).		
Deep Red exterior	FOC	-
<b>Drivers Pack</b> LED daytime running lights, Cruise control, Driver and passenger airbags, Captain's chairs with cab seat covers, Height adjustable seats, Body coloured bumper, Black cab trims (light bezels, grille & skid plate)	£1,995	3kg
<b>Lux Pack</b> 16" alloy wheels, Upgraded 'Silver' Techno dash kit, Loose fit habitation carpets, Pleated cab blinds (front and side blinds), TV aerial and dedicated TV bracket, 40W solar panel and regulator, Reversing sensors.	£1,595	5kg
Upgrade to 140 bhp 2.3 litre engine with manual gearbox	£1,295	-
Upgrade to 140 bhp 2.3 litre engine with 9 speed full automatic transmission (includes upgrade to 16" alloy wheels)	£3,495	33kg
Upgrade to 140 bhp 2.3 litre engine with 9 speed full automatic transmission with Lux Pack	£4,695	38kg
Thule roll-out awning	£795	30kg
'SwiftShield' upholstery fabric	£795	-

### DEALER FIT

For details of dealer fit options please go to page 19.

#### Notes:

Est Estimate

# EDGE SPECIFICATION



464



466\*



476

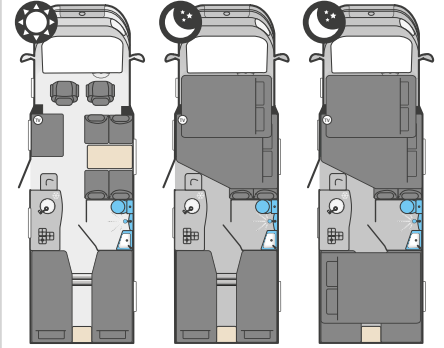
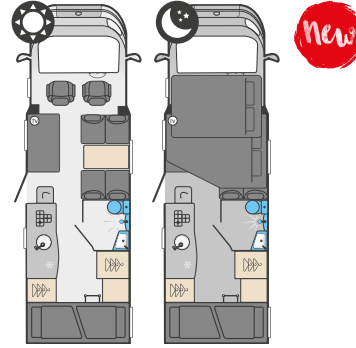
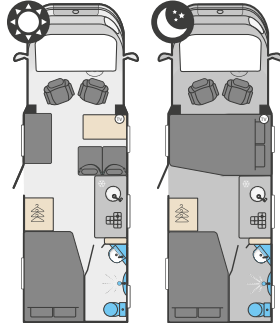

	Standard	Optional	Optional	Standard	Optional	Optional	Standard	Optional	Optional
Fiat MultiJet Diesel Engine	120	140	140 Auto	120	140	140 Auto	120	140	140 Auto
Engine Capacity	2.3 ltr			2.3 ltr			2.3 ltr		
Engine Power	120 HP @ 2750rpm	140 HP @ 3500rpm	140 HP @ 3500rpm	120 HP @ 2750rpm	140 HP @ 3500rpm	140 HP @ 3500rpm	120 HP @ 2750rpm	140 HP @ 3500rpm	140 HP @ 3500rpm
Engine Torque	320 Nm @ 1400rpm	350 Nm @ 1400rpm	350 Nm @ 1400rpm	320 Nm @ 1400rpm	350 Nm @ 1400rpm	350 Nm @ 1400rpm	320 Nm @ 1400rpm	350 Nm @ 1400rpm	350 Nm @ 1400rpm
Roof Profile	Low-Line			High-Line			High-Line		
Wheel Base	3.80m / 12'6"			4.04m / 13'3"			4.04m / 13'3"		
Seat Belts (inc. driver)	4			6			6		
Berths (Sleeping Positions)	4			6			6		
Overall Length	6.75m / 22'2"			7.32m / 24'0"			7.32m / 24'0"		
Overall Width (Mirrors Folded)	2.39m / 7'10"			2.39m / 7'10"			2.39m / 7'10"		
Overall Height (Excludes Roof rack)	2.91m / 9'6"			2.98m / 9'9"			2.98m / 9'9"		
Optional Awning	Thule 4900 3.5m			Thule 4900 3.5m			Thule 4900 3.5m		
Maximum Technical Permissible Laden Mass (A)	3500kg	3500kg	3500kg	3500kg	3650kg	3650kg	3500kg	3500kg	3650kg
Mass in Running Order (B)	2904kg	2904kg	2937kg	2991kg Est	2991kg Est	3024kg Est	2991kg	2991kg	3024kg
Maximum User Payload (A-B)	596kg	596kg	563kg	509kg Est	509kg Est	626kg Est	509kg	509kg	626kg
Essential Habitation Equipment	0kg			0kg			0kg		
Thermal Insulation Grade	THREE			THREE			THREE		
Recommended Maximum Trailer Weight	2000kg			N/A	N/A	2000kg	N/A	N/A	2000kg
Gross Train Weight	5500kg			3500kg	3500kg	5650kg	3500kg	3500kg	5650kg

## BED SIZES

Front Double	215cm x 123cm / 92cm / 7'11" x 4'0" / 3'0"	215cm x 180cm / 121cm / 7'1" x 5'11" / 4'0"	215cm x 180cm / 86cm / 7'1" x 5'11" / 2'10"
Front Nearside Single (inc Cab Seat)			
Front Offside Single (inc Cab Seat)			
Rear Double	188cm x 133cm / 6'2" x 4'4"		214cm x 143cm / 7'0" x 4'8"
Rear Nearside Single			191cm x 83cm / 6'3" x 2'5"
Rear Offside Single			191cm x 83cm / 6'3" x 2'5"
Rear Bunk (Upper)		204cm x 85cm / 6'8" x 2'9" Est	
Rear Bunk (Lower)		204cm x 85cm / 6'8" x 2'9" Est	
Overcab Bed		190cm x 134cm / 6'3" x 4'5"	190cm x 134cm / 6'3" x 4'5"

486



494

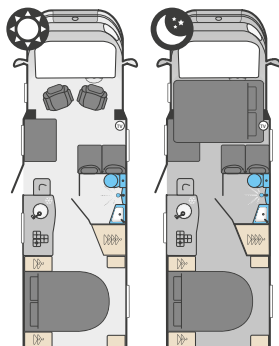
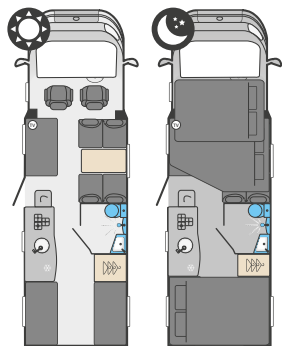

Standard	Optional	Optional	Standard	Optional	Optional
120	140	140 Auto	120	140	140 Auto
2.3 ltr			2.3 ltr		
120 HP @ 2750rpm	140 HP @ 3500rpm	140 HP @ 3500rpm	120 HP @ 2750rpm	140 HP @ 3500rpm	140 HP @ 3500rpm
320 Nm @ 1400rpm	350 Nm @ 1400rpm	350 Nm @ 1400rpm	320 Nm @ 1400rpm	350 Nm @ 1400rpm	350 Nm @ 1400rpm
High-Line			High-Line		
4.04m / 13'3"			4.04m / 13'3"		
6			4		
6			4		
7.32m / 24'0"			7.32m / 24'0"		
2.39m / 7'10"			2.39m / 7'10"		
2.98m / 9'9"			2.98m / 9'9"		
Thule 4900 3.5m			Thule 4900 3.5m		
3500kg	3500kg	3650kg	3500kg	3500kg	3500kg
2991kg	2991kg	3024kg	2975kg	2975kg	3008kg
509kg	509kg	626kg	525kg	525kg	492kg
0kg			0kg		
THREE			THREE		
N/A	N/A	2000kg	2000kg		
3500kg	3500kg	5650kg	5500kg		

215cm x 180cm / 121cm / 7'1" x 5'11" / 4'0"

214cm x 131cm / 7'0" x 4'4"

190cm x 134cm / 6'3" x 4'5"

185cm x 133cm / 6'1" x 4'4"

190cm x 134cm / 6'3" x 4'5"

For General Technical Notes see back cover

## EDGE PRICES

MODEL	CHASSIS	ENGINE	BASIC PRICE	VAT @ 20%	EX WORKS	OTR PRICE
464	3500kg	120bhp	£41,337.50	£8,267.50	£49,605.00	<b>£51,100.00</b>
466*	3500kg	120bhp	£43,270.83	£8,654.17	£51,925.00	<b>£53,420.00</b>
476	3500kg	120bhp	£42,841.67	£8,568.33	£51,410.00	<b>£52,905.00</b>
486	3500kg	120bhp	£42,841.67	£8,568.33	£51,410.00	<b>£52,905.00</b>
494	3500kg	120bhp	£42,841.67	£8,568.33	£51,410.00	<b>£52,905.00</b>

OTR = On the Road.

## OPTIONAL EXTRAS

FACTORY FIT	PRICE	WEIGHT
The following prices are for optional extras fitted at the time of manufacture of the motorhome (Subject to availability).		
<b>Black Edition Pack</b>	£995	-
Black cab, Black Edition graphics, 16" alloy wheels		
Upgrade to 140 bhp 2.3 litre engine with manual gearbox	£1,295	-
Upgrade to 140 bhp 2.3 litre engine with 9 speed full automatic transmission (includes upgrade to 16" alloy wheels)†	£3,495	33kg
Upgrade to 140 bhp 2.3 litre engine with 9 speed full automatic transmission† plus Black Edition pack	£4,095	33kg
16" Alloy wheels	£395	-
Detachable towbar†† and electrics	£655	70kg
Thule roll-out awning (464, 494)	£530	33kg
'SwiftShield' upholstery fabric	£450	-

## DEALER FIT

For details of dealer fit options please go to page 19.

## Notes:

Est. Estimate

\* Available from February 2021

† Requires chassis upgrade to 3650kg on 476 &amp; 486

# Please note that the additional weight of the tow bar and trailer nose weight increases the rear axle loading of the motorhome so care should be taken that the rear axle load is not exceeded when towing. To ensure adequate road holding, the load on the front axle, under all conditions, must not be less than 40% or more than 70% of the total weight. Care must be taken when distributing loads. Please see the Technical Handbook for permissible axle loads, the loadings and weights stated are maximums and must not be exceeded under any circumstances

# ESCAPE COMPACT SPECIFICATION

C205			C404			C502		
------	---	---	------	---	---	------	---	---

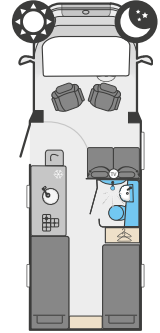
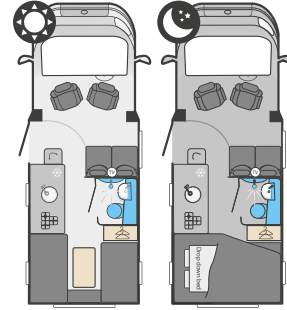
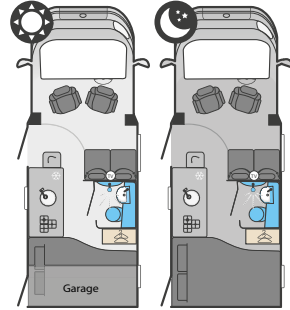

	Standard	Optional	Optional	Standard	Optional	Optional	Standard	Optional	Optional
Fiat MultiJet Diesel Engine	120	140	140 Auto	120	140	140 Auto	120	140	140 Auto
Engine Capacity	2.3 ltr			2.3 ltr			2.3 ltr		
Engine Power	120 HP @ 2750rpm	140 HP @ 3500rpm	140 HP @ 3500rpm	120 HP @ 2750rpm	140 HP @ 3500rpm	140 HP @ 3500rpm	120 HP @ 2750rpm	140 HP @ 3500rpm	140 HP @ 3500rpm
Engine Torque	320 Nm @ 1400rpm	350 Nm @ 1400rpm	350 Nm @ 1400rpm	320 Nm @ 1400rpm	350 Nm @ 1400rpm	350 Nm @ 1400rpm	320 Nm @ 1400rpm	350 Nm @ 1400rpm	350 Nm @ 1400rpm
Roof Profile	Low-Line			Low-Line			Low-Line		
Wheel Base	3.80m / 12'6"			3.80m / 12'6"			3.80m / 12'6"		
Seat Belts (inc. driver)	4			4			4		
Berths (Sleeping Positions)	2			4			2		
Overall Length	5.99m / 19'8"			5.99m / 19'8"			6.65m / 21'10"		
Overall Width (Mirrors Folded)	2.26m / 7'5"			2.26m / 7'5"			2.26m / 7'5"		
Overall Height	2.78m / 9'1"			2.78m / 9'1"			2.78m / 9'1"		
Optional Awning	Thule 4900 3.0m			Thule 4900 3.0m			Thule 4900 3.0m		
Maximum Technical Permissible Laden Mass (A)	3300kg	3300kg	3300kg	3300kg	3300kg	3300kg	3300kg	3300kg	3300kg
Mass in Running Order (B)	2705kg	2705kg	2738kg	2775kg	2775kg	2808kg	2797kg	2797kg	2830kg
Maximum User Payload (A-B)	595kg	595kg	562kg	525kg	525kg	492kg	503kg	503kg	470kg
Essential Habitation Equipment	0kg			0kg			0kg		
Thermal Insulation Grade	THREE			THREE			THREE		
Recommended Maximum Trailer Weight	2000kg			2000kg			2000kg		
Gross Train Weight	5300kg			5300kg			5300kg		

## BED SIZES

Front Double									
Front Nearside Single (inc Cab Seat)									
Front Offside Single (inc Cab Seat)									
Rear Double	194cm x 131cm / 6'4" x 4'4"			193cm x 120cm / 6'4" x 3'11"					
Rear Nearside Single							196cm x 74cm / 6'5" x 2'4"		
Rear Offside Single							184cm x 74cm / 6'0" x 2'4"		
Rear Bunk (Upper)									
Rear Bunk (Lower)									
Drop down bed				183cm x 118cm / 6'1" x 3'10"					

## ESCAPE COMPACT PRICES

MODEL	CHASSIS	ENGINE	BASIC PRICE	VAT @ 20%	EX WORKS	OTR PRICE
C205	3300kg	120bhp	£42,875.00	£8,575.00	£51,450.00	<b>£52,945.00</b>
C404	3300kg	120bhp	£44,983.33	£8,996.67	£53,980.00	<b>£55,475.00</b>
C502	3300kg	120bhp	£43,700.00	£8,740.00	£52,440.00	<b>£53,935.00</b>

OTR = On the Road.

## OPTIONAL EXTRAS

FACTORY FIT The following prices are for optional extras fitted at the time of manufacture of the motorhome (Subject to availability).	PRICE	WEIGHT
Upgrade to 140 bhp 2.3 litre engine with manual gearbox	£1,295	-
Upgrade to 140 bhp 2.3 litre engine with 9 speed full automatic transmission (includes upgrade to 16" alloy wheels)	£3,100	33kg
Detachable towbar* and electrics	£655	40kg
Thule roll-out awning	£530	33kg
'SwiftShield' upholstery fabric	£450	-

### DEALER FIT

For details of dealer fit options please go to page 19.

#### Notes:

Est. Estimate

- # Please note that the additional weight of the tow bar and trailer nose weight increases the rear axle loading of the motorhome so care should be taken that the rear axle load is not exceeded when towing. To ensure adequate road holding, the load on the front axle, under all conditions, must not be less than 40% or more than 70% of the total weight. Care must be taken when distributing loads. Please see the Technical Handbook for permissible axle loads, the loadings and weights stated are maximums and must not be exceeded under any circumstances

# ESCAPE SPECIFICATION



604



614



664

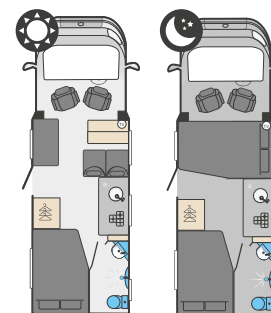
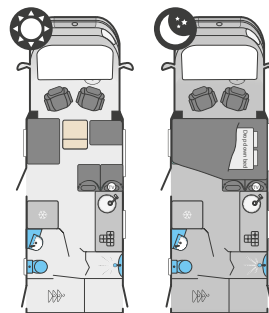
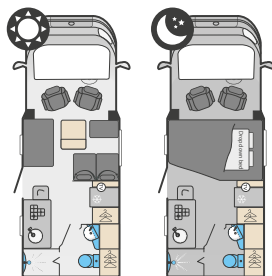

	Standard	Optional	Optional	Standard	Optional	Optional	Standard	Optional	Optional
Fiat MultiJet Diesel Engine	120	140	140 Auto	120	140	140 Auto	120	140	140 Auto
Engine Capacity	2.3 ltr			2.3 ltr			2.3 ltr		
Engine Power	120 HP @ 2750rpm	140 HP @ 3500rpm	140 HP @ 3500rpm	120 HP @ 2750rpm	140 HP @ 3500rpm	140 HP @ 3500rpm	120 HP @ 2750rpm	140 HP @ 3500rpm	140 HP @ 3500rpm
Engine Torque	320 Nm @ 1400rpm	350 Nm @ 1400rpm	350 Nm @ 1400rpm	320 Nm @ 1400rpm	350 Nm @ 1400rpm	350 Nm @ 1400rpm	320 Nm @ 1400rpm	350 Nm @ 1400rpm	350 Nm @ 1400rpm
Roof Profile	Low-Line			Low-Line			Low-Line		
Wheel Base	3.80m / 12'6"			3.80m / 12'6"			3.80m / 12'6"		
Seat Belts (inc. driver)	4			4			4		
Berths (Sleeping Positions)	4			4			4		
Overall Length	5.97m / 19'7"			6.72m / 22'1"			6.72m / 22'1"		
Overall Width (Mirrors Folded)	2.31m / 7'7"			2.31m / 7'7"			2.31m / 7'7"		
Overall Height	2.91m / 9'6"			2.91m / 9'6"			2.91m / 9'6"		
Optional Awning	Thule 6300 3.0m			Thule 6300 3.5m			Thule 6300 3.5m		
Maximum Technical Permissible Laden Mass (A)	3500kg			3500kg			3500kg		
Mass in Running Order (B)	2857kg	2857kg	2890kg	2960kg	2960kg	2993kg	2867kg	2867kg	2900kg
Maximum User Payload (A-B)	643kg	643kg	610kg	540kg	540kg	507kg	633kg	633kg	600kg
Essential Habitation Equipment	0kg			0kg			0kg		
Thermal Insulation Grade	THREE			THREE			THREE		
Recommended Maximum Trailer Weight	2000kg			1600kg			1600kg		
Gross Train Weight	5500kg			5100kg			5100kg		
<b>BED SIZES</b>									
Front Double	209cm x 148cm / 103cm / 6'10" x 4'10" / 3'5"			209cm x 148cm / 103cm / 6'10" x 4'10" / 3'5"			209cm x 123cm / 92cm / 6'9" x 4'0" / 3'0"		
Front Nearside Single (inc Cab Seat)									
Front Offside Single (inc Cab Seat)									
Rear Double							187cm x 126cm / 6'2" x 4'2"		
Rear Nearside Single									
Rear Offside Single									
Rear Bunk (Upper)									
Rear Bunk (Lower)									
Drop Down Bed	193cm x 127cm / 6'4" x 4'2"			193cm x 127cm / 6'4" x 4'2"					



674†			675			684†		
👤👤👤			👤👤👤			👤👤👤		
👤👤👤			👤👤👤			👤👤👤		
Standard	Optional	Optional	Standard	Optional	Optional	Standard	Optional	Optional
120	140	140 Auto	120	140	140 Auto	120	140	140 Auto
2.3 ltr			2.3 ltr			2.3 ltr		
120 HP @ 2750rpm	140 HP @ 3500rpm	140 HP @ 3500rpm	120 HP @ 2750rpm	140 HP @ 3500rpm	140 HP @ 3500rpm	120 HP @ 2750rpm	140 HP @ 3500rpm	140 HP @ 3500rpm
320 Nm @ 1400rpm	350 Nm @ 1400rpm	350 Nm @ 1400rpm	320 Nm @ 1400rpm	350 Nm @ 1400rpm	350 Nm @ 1400rpm	320 Nm @ 1400rpm	350 Nm @ 1400rpm	350 Nm @ 1400rpm
Low-Line			Low-Line			Low-Line		
4.65m / 15'3"			4.65m / 15'3"			4.30m / 14'1"		
4 (Opt 5)			4			4 (Opt 5)		
4 (Opt 6)			4			4 (Opt 6)		
7.41m / 24'4"			7.86m / 25'9"			7.41m / 24'4"		
2.31m / 7'7"			2.31m / 7'7"			2.31m / 7'7"		
2.88m / 9'5"			2.88m / 9'5"			2.88m / 9'5"		
Thule 6300 4.25m			Thule 6300 4.25m			Thule 6300 4.25m		
3500kg			3500kg			3500kg		
2942kg	2942kg	2975kg	2990kg	2990kg	3023kg	2940kg	2940kg	2973kg
558kg	558kg	525kg	510kg	510kg	477kg	560kg	560kg	527kg
0kg			0kg			0kg		
THREE			THREE			THREE		
2000kg			2000kg			2000kg		
5500kg			5500kg			5500kg		
209cm x 148cm / 103cm / 6'10" x 4'10" / 3'5"			209cm x 148cm / 103cm / 6'10" x 4'10" / 3'5"			209cm x 148cm / 103cm / 6'10" x 4'10" / 3'5"		
206cm x 183cm / 6'9" x 6'0"			190cm x 72cm / 6'3" x 2'4"			208cm x 145cm / 6'10" x 4'9"		
183cm x 68cm / 6'0" x 2'3"			180cm x 72cm / 5'11" x 2'4"			192cm x 80cm / 6'4" x 2'7"		
191cm x 68cm / 6'3" x 2'3"						192cm x 80cm / 6'4" x 2'7"		
193cm x 127cm / 6'3" x 4'2"						193cm x 127cm / 6'4" x 4'2"		

CONTINUED...

For General Technical Notes see back cover

# ESCAPE SPECIFICATION ...CONTINUED



694†

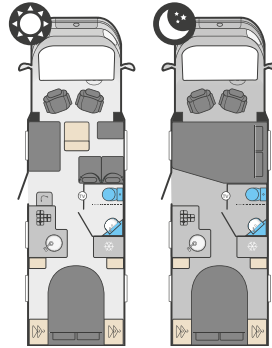

9th berth &  
drop down  
bed option  
available

	Standard	Optional	Optional
Fiat MultiJet Diesel Engine	120	140	140 Auto
Engine Capacity	2.3 ltr		
Engine Power	120 HP @ 2750rpm	140 HP @ 3500rpm	140 HP @ 3500rpm
Engine Torque	320 Nm @ 1400rpm	350 Nm @ 1400rpm	350 Nm @ 1400rpm
Roof Profile	Low-Line		
Wheel Base	4.30m / 14'1"		
Seat Belts (inc. driver)	4 (Opt 5)		
Berths (Sleeping Positions)	4 (Opt 6)		
Overall Length	7.41m / 24'4"		
Overall Width (Mirrors Folded)	2.31m / 7'7"		
Overall Height	2.88m / 9'5"		
Optional Awning	Thule 6300 4.25m		
Maximum Technical Permissible Laden Mass (A)	3500kg		
Mass in Running Order (B)	2922kg	2922kg	2955kg
Maximum User Payload (A-B)	578kg	578kg	545kg
Essential Habitation Equipment	0kg		
Thermal Insulation Grade	THREE		
Recommended Maximum Trailer Weight	2000kg		
Gross Train Weight	5500kg		
<b>BED SIZES</b>			
Front Double	209cm x 148cm / 103cm / 6'10" x 4'10" / 3'5"		
Front Nearside Single (inc Cab Seat)			
Front Offside Single (inc Cab Seat)			
Rear Double	183cm x 133cm / 6'0" x 4'4"		
Rear Nearside Single			
Rear Offside Single			
Rear Bunk (Upper)			
Rear Bunk (Lower)			
Drop Down Bed	193cm x 127cm / 6'4" x 4'2"		

For General Technical Notes see back cover

## ESCAPE PRICES

MODEL	CHASSIS	ENGINE	BASIC PRICE	VAT @ 20%	EX WORKS	OTR PRICE
604	3500kg	120bhp	£45,583.33	£9,116.67	£54,700.00	<b>£56,195.00</b>
614	3500kg	120bhp	£46,058.33	£9,211.67	£55,270.00	<b>£56,765.00</b>
664	3500kg	120bhp	£45,400.00	£9,080.00	£54,480.00	<b>£55,975.00</b>
674	3500kg	120bhp	£47,400.00	£9,480.00	£56,880.00	<b>£58,375.00</b>
675	3500kg	120bhp	£47,400.00	£9,480.00	£56,880.00	<b>£58,375.00</b>
684	3500kg	120bhp	£47,308.33	£9,461.67	£56,770.00	<b>£58,265.00</b>
694	3500kg	120bhp	£47,245.83	£9,449.17	£56,695.00	<b>£58,190.00</b>

OTR = On the Road.

## OPTIONAL EXTRAS

FACTORY FIT	PRICE	WEIGHT
The following prices are for optional extras fitted at the time of manufacture of the motorhome (Subject to availability).		
Upgrade to 140 bhp 2.3 litre engine with manual gearbox	£1,295	-
Upgrade to 140 bhp 2.3 litre engine with 9 speed full automatic transmission	£3,100	33kg
Thule roll-out awning (increases height of vehicle by 25mm)	£795	33kg
Detachable towbar* and electrics (Escape 604 only)	£655	40kg
Detachable towbar* and electrics (all Escape models except 604)	£595	40kg
5 Seat belt option & drop down bed (674, 684 & 694 only)	£1,695	100kg
'SwiftShield' upholstery fabric	£450	-

### DEALER FIT

For details of dealer fit options please go to page 19.

#### Notes:

- # Please note that the additional weight of the tow bar and trailer nose weight increases the rear axle loading of the motorhome so care should be taken that the rear axle load is not exceeded when towing. To ensure adequate road holding, the load on the front axle, under all conditions, must not be less than 40% or more than 70% of the total weight. Care must be taken when distributing loads. Please see the Technical Handbook for permissible axle loads, the loadings and weights stated are maximums and must not be exceeded under any circumstances

#### † Optional 5th belt and drop down bed spec

An additional belted travelling seat and drop down bed can be added to the 674, 684 & 694:

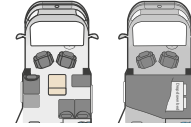

Berths (sleeping positions)	+2
Reduced payload due to addition of seat and bed	- 100kg
All other specification as table	

**Note:** The mass of the additional passenger must be taken into consideration when loading the vehicle

# KON-TIKI SPORT SPECIFICATION



560	👤👤👤		👤👤👤👤		560 LOUNGE	👤👤👤		👤👤		574	👤👤👤		👤👤👤👤	

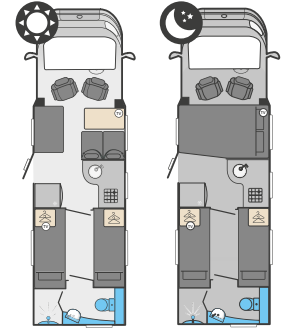
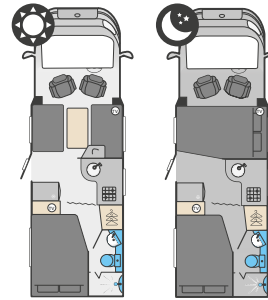
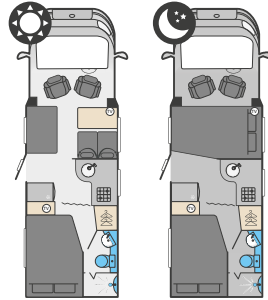

	Standard	Optional	Optional	Optional	Standard	Optional	Optional	Optional	Standard	Optional	Optional	Optional
Fiat MultiJet Diesel Engine	140	140 Auto	160	160 Auto	140	140 Auto	160	160 Auto	140	140 Auto	160	160 Auto
Engine Capacity	2.3 ltr				2.3 ltr				2.3 ltr			
Engine Power	140 HP @ 3500rpm		160 HP @ 3500rpm		140 HP @ 3500rpm		160 HP @ 3500rpm		140 HP @ 3500rpm		160 HP @ 3500rpm	
Engine Torque	350 Nm @ 1400rpm		380 Nm @ 1500rpm / 400 Nm @ 1500rpm		350 Nm @ 1400rpm		380 Nm @ 1500rpm / 400 Nm @ 1500rpm		350 Nm @ 1400rpm		380 Nm @ 1500rpm / 400 Nm @ 1500rpm	
Roof Profile	Low-Line				Low-Line				Low-Line			
Wheel Base	4.04m / 13'3"				4.04m / 13'3"				4.40m / 14'5"			
Seat Belts (inc. driver)	4				2				4			
Berths (Sleeping Positions)	4				4				4			
Overall Length (No Ladder)**	7.09m / 23'3"				7.09m / 23'3"				7.77m / 25'6"			
Overall Width (Mirrors Folded)	2.38m / 7'10"				2.38m / 7'10"				2.38m / 7'10"			
Overall Height (Excludes Roof rack)	2.82m / 9'3"				2.82m / 9'3"				2.76m / 9'1"			
Optional Awning	Thule 4900 3.5m				Thule 4900 3.5m				Thule 4900 4.5m			
Maximum Technical Permissible Laden Mass (A)	3500kg	3650kg	3650kg	3650kg	3500kg				4250kg			
Mass in Running Order (B)	3157kg	3190kg	3172kg	3190kg	3117kg	3150kg	3132kg	3150kg	3345kg	3378kg	3360kg	3378kg
Maximum User Payload (A-B)	343kg	460kg	478kg	460kg	383kg	350kg	368kg	350kg	905kg	872kg	890kg	872kg
Essential Habitation Equipment	0kg				0kg				0kg			
Thermal Insulation Grade	THREE				THREE				THREE			
Recommended Maximum Trailer Weight	1600kg				1600kg				2000kg ‡			
Gross Train Weight	5100kg	5250kg	5250kg	5250kg	5100kg				6000kg			

## BED SIZES

Front Double	209cm x 123cm / 103cm / 6'10" x 4'0" / 3'5"				201cm x 120cm / 103cm / 6'7" x 3'11" / 3'5"				209cm x 123cm / 103cm / 6'10" x 4'0" / 3'5"			
Front Nearside Single (inc Cab Seat)												
Front Offside Single (inc Cab Seat)												
Rear Double	190cm x 126cm / 6'3" x 4'2"				190cm x 126cm / 6'3" x 4'2"							
Rear Nearside Single									201cm x 75cm / 6'7" x 2'5"			
Rear Offside Single									192cm x 75cm / 6'4" x 2'5"			
Rear Bunk (Upper)												
Rear Bunk (Lower)												
Drop Down Bed												

## 574 LOUNGE



## 584



## 584 LOUNGE

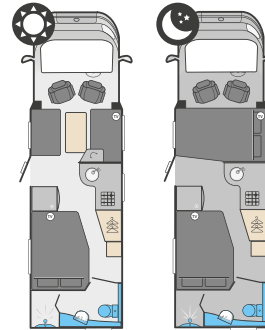
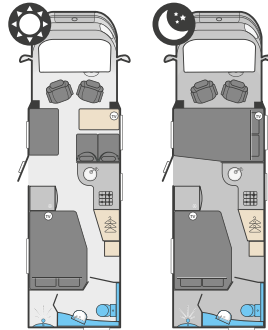
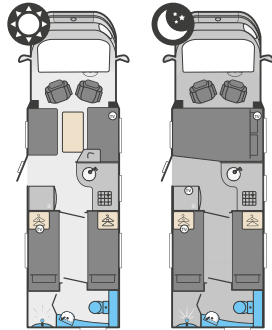

574 LOUNGE				584				584 LOUNGE			
Standard	Optional	Optional	Optional	Standard	Optional	Optional	Optional	Standard	Optional	Optional	Optional
140	140 Auto	160	160 Auto	140	140 Auto	160	160 Auto	140	140 Auto	160	160 Auto
2.3 ltr				2.3 ltr				2.3 ltr			
140 HP @ 3500rpm		160 HP @ 3500rpm		140 HP @ 3500rpm		160 HP @ 3500rpm		140 HP @ 3500rpm		160 HP @ 3500rpm	
350 Nm @ 1400rpm		380 Nm @ 1500rpm		350 Nm @ 1400rpm		380 Nm @ 1500rpm		350 Nm @ 1400rpm		380 Nm @ 1500rpm	
		400 Nm @ 1500rpm				400 Nm @ 1500rpm				400 Nm @ 1500rpm	
Low-Line				Low-Line				Low-Line			
4.40m / 14'5"				4.40m / 14'5"				4.40m / 14'5"			
2				4				2			
4				4				4			
7.77m / 25'6"				7.77m / 25'6"				7.77m / 25'6"			
2.38m / 7'10"				2.38m / 7'10"				2.38m / 7'10"			
2.76m / 9'1"				2.76m / 9'1"				2.76m / 9'1"			
Thule 4900 4.5m				Thule 4900 4.5m				Thule 4900 4.5m			
3500kg				4250kg				3500kg			
3247kg	3295kg	3262kg	3295kg	3295kg	3328kg	3310kg	3328kg	3200kg	3248kg	3215kg	3248kg
253kg	205kg	238kg	205kg	955kg	922kg	940kg	922kg	300kg	252kg	285kg	252kg
0kg				0kg				0kg			
THREE				THREE				THREE			
2000kg				2000kg ‡				2000kg			
5500kg				6000kg				5500kg			
201cm x 120cm / 103cm / 6'7" x 3'11" / 3'5"				209cm x 123cm / 103cm / 6'10" x 4'0" / 3'5"				201cm x 120cm / 103cm / 6'7" x 3'11" / 3'5"			
				199cm x 131cm / 6'6" x 4'4"				199cm x 131cm / 6'6" x 4'4"			
201cm x 75cm / 6'7" x 2'5"											
192cm x 75cm / 6'4" x 2'5"											

**CONTINUED...**

For General Technical Notes see back cover

# KON-TIKI SPORT SPECIFICATION ...CONTINUED

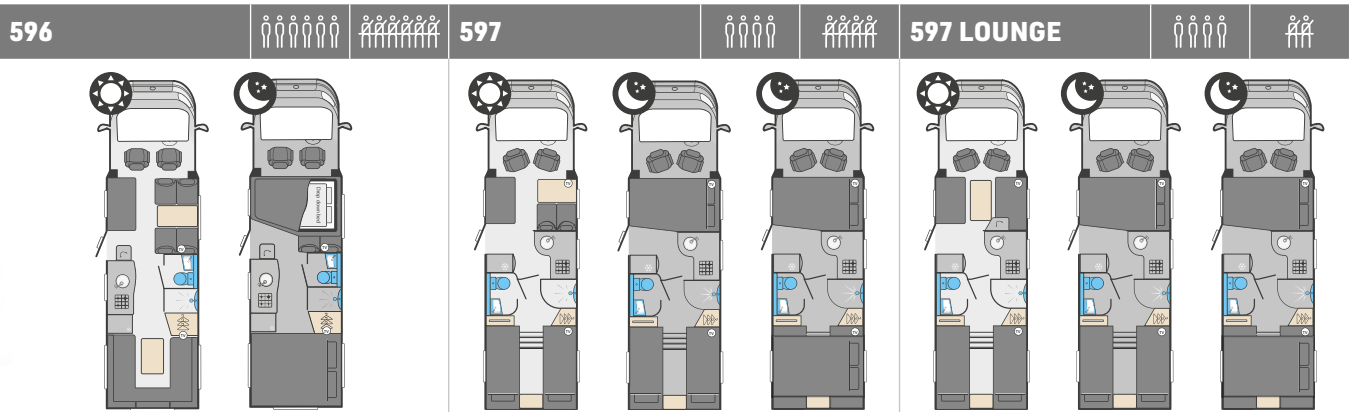

	596				597				597 LOUNGE			
	Standard	Optional	Optional	Optional	Standard	Optional	Optional	Optional	Standard	Optional	Optional	Optional
Fiat MultiJet Diesel Engine	140	140 Auto	160	160 Auto	140	140 Auto	160	160 Auto	140	140 Auto	160	160 Auto
Engine Capacity	2.3 ltr				2.3 ltr				2.3 ltr			
Engine Power	140 HP @ 3500rpm		160 HP @ 3500rpm		140 HP @ 3500rpm		160 HP @ 3500rpm		140 HP @ 3500rpm		160 HP @ 3500rpm	
Engine Torque	350 Nm @ 1400rpm		380 Nm @ 1500rpm / 400 Nm @ 1500rpm		350 Nm @ 1400rpm		380 Nm @ 1500rpm / 400 Nm @ 1500rpm		350 Nm @ 1400rpm		380 Nm @ 1500rpm / 400 Nm @ 1500rpm	
Roof Profile	High-Line				Low-Line				Low-Line			
Wheel Base	4.70m / 15'5"				4.70m / 15'5"				4.70m / 15'5"			
Seat Belts (inc. driver)	6				4				2			
Berths (Sleeping Positions)	6				4				4			
Overall Length (No Ladder)*	8.11m / 26'7"				8.11m / 26'7"				8.11m / 26'7"			
Overall Width (Mirrors Folded)	2.38m / 7'10"				2.38m / 7'10"				2.38m / 7'10"			
Overall Height (Excludes Roof rack)	2.82m / 9'3"				2.76m / 9'1"				2.76m / 9'1"			
Optional Awning	Thule 4900 4.5m				Thule 4900 4.5m				Thule 4900 4.5m			
Maximum Technical Permissible Laden Mass (A)	4250kg				4250kg				4250kg			
Mass in Running Order (B)	3497kg	3530kg	3512kg	3530kg	3425kg	3458kg	3440kg	3458kg	3375kg	3408kg	3390kg	3408kg
Maximum User Payload (A-B)	753kg	720kg	738kg	720kg	825kg	792kg	810kg	792kg	875kg	842kg	860kg	842kg
Essential Habitation Equipment	0kg				0kg				0kg			
Thermal Insulation Grade	THREE				THREE				THREE			
Recommended Maximum Trailer Weight	2000kg ‡				2000kg ‡				2000kg ‡			
Gross Train Weight	6000kg*				6000kg				6000kg			

## BED SIZES

Front Double	209cm x 180cm / 121cm / 6'10" x 5'11" / 4'0"				209cm x 123cm / 103cm / 6'10" x 4'0" / 3'5"				201cm x 120cm / 103cm / 6'7" x 3'11" / 3'5"			
Front Nearside Single (inc Cab Seat)												
Front Offside Single (inc Cab Seat)												
Rear Double	202cm x 163cm / 6'8" x 5'4"				216cm x 120cm / 7'1" x 3'11"				216cm x 120cm / 7'1" x 3'11"			
Rear Nearside Single	173cm x 69cm / 5'8" x 2'3"				199cm x 81cm / 6'6" x 2'8"				199cm x 81cm / 6'6" x 2'8"			
Rear Offside Single	163cm x 69cm / 5'4" x 2'3"				199cm x 81cm / 6'6" x 2'8"				199cm x 81cm / 6'6" x 2'8"			
Rear Bunk (Upper)												
Rear Bunk (Lower)												
Drop Down Bed	196cm x 133cm / 6'5" x 4'4"											

599



599 LOUNGE

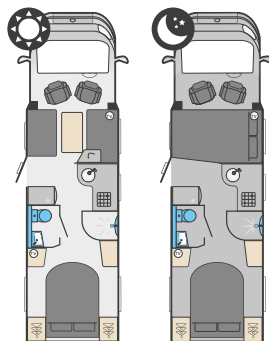
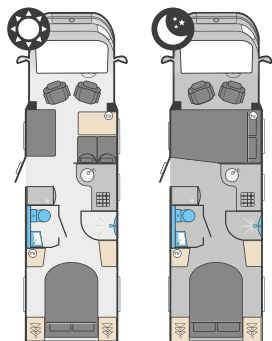

Standard	Optional	Optional	Optional	Standard	Optional	Optional	Optional
140	140 Auto	160	160 Auto	140	140 Auto	160	160 Auto
2.3 ltr				2.3 ltr			
140 HP @ 3500rpm		160 HP @ 3500rpm		140 HP @ 3500rpm		160 HP @ 3500rpm	
350 Nm @ 1400rpm		380 Nm @ 1500rpm		350 Nm @ 1400rpm		380 Nm @ 1500rpm	
		400 Nm @ 1500rpm				400 Nm @ 1500rpm	
Low-Line				Low-Line			
4.70m / 15'5"				4.70m / 15'5"			
4				2			
4				4			
8.11m / 26'7"				8.11m / 26'7"			
2.38m / 7'10"				2.38m / 7'10"			
2.76m / 9'1"				2.76m / 9'1"			
Thule 4900 4.5m				Thule 4900 4.5m			
4250kg				4250kg			
3405kg	3438kg	3420kg	3438kg	3355kg	3388kg	3370kg	3388kg
845kg	812kg	830kg	812kg	895kg	862kg	880kg	862kg
0kg				0kg			
THREE				THREE			
2000kg ‡				2000kg ‡			
6000kg				6000kg			
209cm x 123cm / 103cm / 6'10" x 4'0" / 3'5"				201cm x 120cm / 103cm / 6'7" x 3'11" / 3'5"			
200cm x 133cm / 6'7" x 4'5"				200cm x 133cm / 6'7" x 4'5"			

**CONTINUED...**

For General Technical Notes see back cover

## KON-TIKI SPORT PRICES

MODEL	CHASSIS	ENGINE	BASIC PRICE	VAT @ 20%	EX WORKS	OTR PRICE
560 / 560 Lounge	3500kg	140bhp	£56,883.33	£11,376.67	£68,260.00	<b>£69,755.00</b>
574	4250kg	140bhp	£57,883.33	£11,576.67	£69,460.00	<b>£70,955.00</b>
574 Lounge	3500kg	140bhp	£57,883.33	£11,576.67	£69,460.00	<b>£70,955.00</b>
584	4250kg	140bhp	£57,883.33	£11,576.67	£69,460.00	<b>£70,955.00</b>
584 Lounge	3500kg	140bhp	£57,883.33	£11,576.67	£69,460.00	<b>£70,955.00</b>
596	4250kg	140bhp	£60,750.00	£12,150.00	£72,900.00	<b>£74,395.00</b>
597 / 597 Lounge	4250kg	140bhp	£57,883.33	£11,576.67	£69,460.00	<b>£70,955.00</b>
599 / 599 Lounge	4250kg	140bhp	£57,883.33	£11,576.67	£69,460.00	<b>£70,955.00</b>

OTR = On the Road

## OPTIONAL EXTRAS

FACTORY FIT The following prices are for optional extras fitted at the time of manufacture of the motorhome (Subject to availability).	PRICE	WEIGHT
Upgrade to 140 bhp 2.3 litre engine with 9 speed full automatic transmission	£2,495	33kg*
Upgrade to 160 bhp 2.3 litre engine with manual gearbox	£1,895	15kg
Upgrade to 160 bhp 2.3 litre engine with 9 speed full automatic transmission	£4,390	33kg*
Roof rack and ladder**	£630	18kg
Detachable towbar* and electrics (574 Lounge requires Chassis upgrade to 3650kg)	£595	40kg
'Shelly' full leather furnishing scheme (except 596)	£1,495	-
'Shelly' full leather furnishing scheme (596 only)	£2,295	-
'SwiftShield' upholstery fabric (except 596)	£795	-
'SwiftShield' upholstery fabric (596 only)	£1,295	-

### DEALER FIT

For details of dealer fit options please go to page 19.

#### Notes:

\* 48kg on 574 & 584 Lounge

\*\* For optional roof ladder add 125mm to length

# Please note that the additional weight of the tow bar and trailer nose weight increases the rear axle loading of the motorhome so care should be taken that the rear axle load is not exceeded when towing. To ensure adequate road holding, the load on the front axle, under all conditions, must not be less than 40% or more than 70% of the total weight. Care must be taken when distributing loads. Please see the Technical Handbook for permissible axle loads, the loadings and weights stated are maximums and must not be exceeded under any circumstances

‡ The maximum trailer weight is limited by the gross train weight which must not be exceeded. For example if a vehicle with a gross train weight of 6000kg is loaded to the maximum MTPM of 4250kg, then the maximum trailer weight possible is 1750kg. Reducing the weight of the vehicle by removing payload, will allow you to increase the trailer weight up to a maximum of 2000kg.



# KON-TIKI SPECIFICATION



## 625 HIGH-LINE



## 635 LOW-LINE



## 635 HIGH-LINE

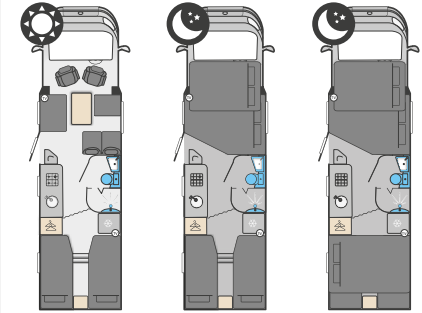
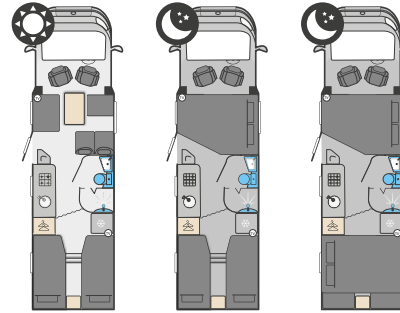
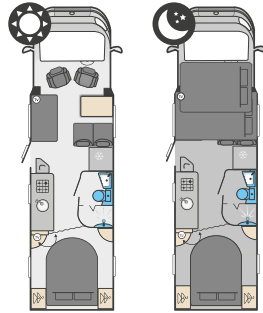

	Standard		Optional		Standard		Optional		Standard		Optional	
Fiat MultiJet Diesel Engine	160		160 Auto		160		160 Auto		160		160 Auto	
Engine Capacity	2.3 ltr				2.3 ltr				2.3 ltr			
Engine Power	160 HP @ 3500rpm				160 HP @ 3500rpm				160 HP @ 3500rpm			
Engine Torque	380 Nm @ 1500rpm		400 Nm @ 1500rpm		380 Nm @ 1500rpm		400 Nm @ 1500rpm		380 Nm @ 1500rpm		400 Nm @ 1500rpm	
Roof Profile	High-Line				Low-Line				High-Line			
Wheel Base	4.60m / 15'1"				4.60m / 15'1"				4.60m / 15'1"			
Seat Belts (inc. driver)	4				4				4			
Berths (Sleeping Positions)	6				4				6			
Overall Length	8.19m / 26'10"				8.19m / 26'10"				8.19m / 26'10"			
Overall Width (Mirrors Folded)	2.35m / 7'9"				2.35m / 7'9"				2.35m / 7'9"			
Overall Height (Excludes Roof rack)	3.13m / 10'3"				3.02m / 9'11"				3.13m / 10'3"			
Optional Awning	Thule 8000 4.5m				Thule 8000 4.5m				Thule 8000 4.5m			
Maximum Technical Permissible Laden Mass (A)	4250kg				4250kg				4250kg			
Mass in Running Order (B)	3815kg		3833kg		3775kg		3793kg		3825kg		3843kg	
Maximum User Payload (A-B)	435kg		417kg		475kg		457kg		425kg		407kg	
Essential Habitation Equipment	0kg				0kg				0kg			
Thermal Insulation Grade	THREE				THREE				THREE			
Recommended Maximum Trailer Weight ‡	1750kg < 2000kg *				1750kg < 2000kg *				1750kg < 2000kg *			
Gross Train Weight ‡	6000kg				6000kg				6000kg			
<b>BED SIZES</b>												
Front Double	209cm x 112cm / 6'10" x 3'8"				204cm x 94cm / 6'8" x 3'1"				204cm x 94cm / 6'8" x 3'1"			
Front Nearside Single (inc Cab Seat)												
Front Offside Single (inc Cab Seat)												
Rear Double	192cm x 143cm / 6'4" x 4'8"				203cm x 138cm / 6'8" x 4'6"				203cm x 138cm / 6'8" x 4'6"			
Rear Nearside Single					193cm x 81cm / 6'4" x 2'8"				193cm x 81cm / 6'4" x 2'8"			
Rear Offside Single					193cm x 81cm / 6'4" x 2'8"				193cm x 81cm / 6'4" x 2'8"			
Overcab Bed	190cm x 134cm / 6'3" x 4'5"								190cm x 134cm / 6'3" x 4'5"			

### 649 HIGH-LINE



### 650 HIGH-LINE



### 675 HIGH-LINE

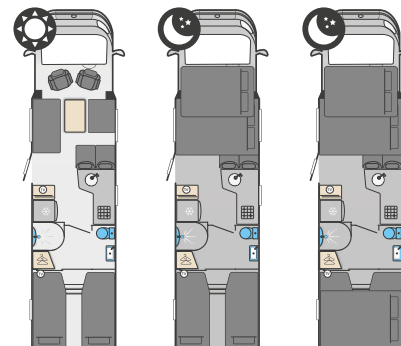
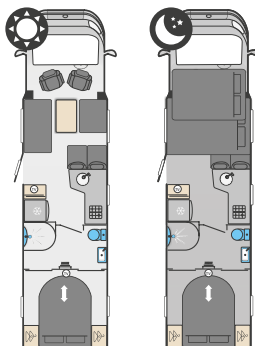
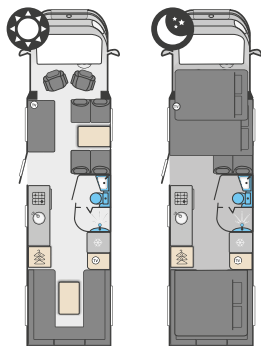

Standard		Optional		Optional		Optional		Standard		Optional		Optional		Optional	
160		160 Auto		180		180 Auto		160		160 Auto		180		180 Auto	
2.3 ltr				2.3 ltr				2.3 ltr				2.3 ltr			
160 HP @ 3500rpm		178 HP @ 3500rpm		160 HP @ 3500rpm		178 HP @ 3500rpm		160 HP @ 3500rpm		178 HP @ 3500rpm		160 HP @ 3500rpm		178 HP @ 3500rpm	
380 Nm @ 1500rpm		400 Nm @ 1500rpm		400 Nm @ 1500rpm		450 Nm @ 1500rpm		380 Nm @ 1500rpm		400 Nm @ 1500rpm		400 Nm @ 1500rpm		450 Nm @ 1500rpm	
High-Line				High-Line				High-Line				High-Line			
4.60m / 15'1" - 0.80m / 2'7"				4.6m / 15'1" - 0.80m / 2'7"				4.6m / 15'1" - 0.80m / 2'7"				4.6m / 15'1" - 0.80m / 2'7"			
6				4				6				6			
6				6				9.01m / 29'7"				9.01m / 29'7"			
9.01m / 29'7"				2.35m / 7'9"				2.35m / 7'9"				2.35m / 7'9"			
2.35m / 7'9"				3.13m / 10'3"				3.13m / 10'3"				3.13m / 10'3"			
3.13m / 10'3"				Thule 8000 5.5m				Thule 8000 5.5m				Thule 8000 5.5m			
Thule 8000 5.5m				4800kg				4800kg				4800kg			
4147kg		4165kg		4147kg		4165kg		4147kg Est.		4165kg Est.		4147kg Est.		4165kg Est.	
653kg		635kg		653kg		635kg		653kg Est.		635kg Est.		653kg Est.		635kg Est.	
0kg				0kg				0kg				0kg			
THREE				THREE				THREE				THREE			
1200kg < 1600kg				1200kg < 1600kg				1200kg < 1600kg				1200kg < 1600kg			
6000kg				6000kg				6000kg				6000kg			
204cm x 135cm / 6'8" x 4'5"				204cm x 135cm / 6'8" x 4'5"				204cm x 135cm / 6'8" x 4'5"				204cm x 135cm / 6'8" x 4'5"			
201cm x 193cm / 6'7" x 6'4"				192cm x 143cm / 6'4" x 4'8"				203cm x 138cm / 6'8" x 4'6"				203cm x 138cm / 6'8" x 4'6"			
193cm x 69cm / 6'4" x 2'3"				193cm x 69cm / 6'4" x 2'3"				193cm x 81cm / 6'4" x 2'8"				193cm x 81cm / 6'4" x 2'8"			
193cm x 69cm / 6'4" x 2'3"				190cm x 134cm / 6'3" x 4'5"				190cm x 134cm / 6'3" x 4'5"				190cm x 134cm / 6'3" x 4'5"			
190cm x 134cm / 6'3" x 4'5"				190cm x 134cm / 6'3" x 4'5"				190cm x 134cm / 6'3" x 4'5"				190cm x 134cm / 6'3" x 4'5"			

For General Technical Notes see back cover

## KON-TIKI PRICES

MODEL	CHASSIS	ENGINE	BASIC PRICE	VAT @ 20%	EX WORKS	OTR PRICE
625	4250kg	160bhp	£76,216.67	£15,243.33	£91,460.00	<b>£92,955.00</b>
635	4250kg	160bhp	£76,216.67	£15,243.33	£91,460.00	<b>£92,955.00</b>
649	4800kg	160bhp	£84,533.33	£16,906.67	£101,440.00	<b>£102,935.00</b>
650	4800kg	160bhp	£84,533.33	£16,906.67	£101,440.00	<b>£102,935.00</b>
675	4800kg	160bhp	£84,533.33	£16,906.67	£101,440.00	<b>£102,935.00</b>

OTR = On the Road

## OPTIONAL EXTRAS

FACTORY FIT The following prices are for optional extras fitted at the time of manufacture of the motorhome (Subject to availability).	PRICE	WEIGHT
Upgrade to 160 bhp 2.3 litre engine with 9 speed full automatic transmission	£2,495	18kg
Upgrade to 180 bhp 2.3 litre engine with manual gearbox (649, 650, & 675)	£1,895	-
Upgrade to 180 bhp 2.3 litre engine with 9 speed full automatic transmission (649, 650, & 675)	£4,390	18kg
Roof bars	£550	18kg
Detachable towbar* and electrics	£595	40kg
'Shelly' full leather furnishing scheme (except Kon-Tiki 649)	£1,495	-
'Shelly' full leather furnishing scheme (Kon-Tiki 649 only)	£2,295	-

### Notes:

Est. Estimate

# Please note that the additional weight of the tow bar and trailer nose weight increases the rear axle loading of the motorhome so care should be taken that the rear axle load is not exceeded when towing. To ensure adequate road holding, the load on the front axle, under all conditions, must not be less than 40% or more than 70% of the total weight. Care must be taken when distributing loads. Please see the Technical Handbook for permissible axle loads, the loadings and weights stated are maximums and must not be exceeded under any circumstances.

‡ The maximum trailer weight is limited by the gross train weight which must not be exceeded. For example, if the vehicle is at the maximum MTPLM of 4800kg, then the maximum trailer weight possible is 1200kg. Reducing the weight of the vehicle by removing payload, will allow you to increase the trailer weight up to a maximum of 1600kg

\* The maximum trailer nose weight is limited to 40kg

## OPTIONAL EXTRAS: DEALER FIT

ALL SWIFT MOTORHOMES	PRICE
Swift Command Tracker by Sargent annual subscription	£95

ALL SWIFT COACHBUILT MOTORHOMES	PRICE
Thule Elite G2 two cycle rack (Exc. Kon-Tiki)	£315
Roof mounted air conditioning unit (model dependent)	£POA†

SWIFT EDGE	PRICE
Thule roll-out awning (466, 476 & 486)	£530
3650kg chassis upgrade	£99

SWIFT ESCAPE	PRICE
3650kg chassis upgrade	£99

SWIFT KON-TIKI SPORT	PRICE
3650kg chassis upgrade (560, 560 Lounge, 574 Lounge & 584 Lounge models only)	£99

SWIFT KON-TIKI	PRICE
Thule Veloslides (635 & 675 only)	£POA
Thule Velo Space XT 2 Bike	£POA
Thule Velo Space XT 3 Bike	£POA
Thule Easyfold XT 2 Bike 13 pin	£POA
Thule Easyfold XT 3 Bike 13 pin	£POA

### Notes:

† Excludes dealer installation charge. Limitations may apply on air conditioning units. Please consult your dealer on the suitability of individual models.



**SWIFT**  
CREATING SMILES FOR LIFE



## PRICE NOTES

On the road (OTR) price includes a recommended cost of £1,495.00 to cover delivery to dealer in Great Britain, a set of number plates (inc. VAT), 12 months road fund licence and first registration fee. See model for price details.

Recommended retail prices for 2021 models effective from 1st May 2021.  
This price list supersedes all previous price lists.

## GENERAL TECHNICAL NOTES

- The Maximum User Payload includes:
  - the conventional load (this is the allowance for passengers)
  - essential habitation equipment (items and fluids required for safe and proper functioning of habitation equipment)
  - optional equipment (items available from the manufacturer over and above the standard specification)
  - personal effects (those items not covered by the above)
- The Mass in Running Order is the mass of the unladen vehicle including a 75kg allowance for the driver plus engine coolants and 90% of the fuel tank capacity and 1 x 6kg Calor Lite LPG cylinder. The MRO is calculated with the fresh water tank empty. If you travel with water in the fresh water tank then the payload will reduce accordingly.
- Please take care to ensure that you have allowed for the masses of all items you intend to carry in the motorhome, e.g. passengers, optional equipment, essential habitation equipment and personal effects, such as clothing, food, pets, bicycles, sailboards, sports equipment etc.
- Warning - under no circumstances should the maximum technical permissible laden mass of this motorhome be exceeded.

## DISCLAIMER

This brochure does not constitute an offer by Swift Group Limited (Swift). Swift reserves the right to alter specifications and prices at any time as materials and conditions demand. Distributors and dealers sell Swift products on their own account and not as agents of Swift. Accordingly, they have no authority to bind Swift or to make any representation or undertaking whatsoever on behalf of Swift. Issued May 2021.

## VISIT SWIFTGROUP.CO.UK TO...



Configure your model



Watch videos



Download brochure



Find a dealer

## FOLLOW THE SWIFT FAMILY

